

Practical Computing

60p

October 1980

Volume 3 Issue 10



**Run for President—
U.S. Election Game**

**Reviews:
SuperPet
Vector Graphic B
Desktop Plan**

**Computer Education:
Junior Minister
interviewed**

Chess Game Survey



The best computers PLUS the best service

At MicroCentre, we're concentrating our resources on what we genuinely believe are the very best computers available today. . . . Cromemco computers, naturally. This way we can offer you the best deal possible.

What we don't do

What we don't do is spread our expertise thinly amongst umpteen different systems, or try to stock every S100 product on the market. We don't claim to offer "impartial" advice on the best buy. And we don't sell from price lists or catalogues.

The MicroCentre approach

Some micro-computer suppliers work like that, but we don't. Because we realise that when you're buying a computer you want more than the "brochures and boxes" approach. You want to see computers running; to try them out with different software products; to study the documentation; above all, you want expert answers to your most searching questions.

Cromemco specialists

That's why we've specialised in Cromemco systems. Not simply because we think Cromemco systems are the best serious computers available at the price.



MicroCentre's Cromemco demonstration room, with the full range of Cromemco computers, peripherals, operating systems and software products on permanent exhibition. Why not pay us a visit? We're only an hour's Shuttle flight from Heathrow!



Cromemco Model Z-2H hard disc computer. 10 megabyte hard disc, 2 floppy discs, Z-80 computer and 64K memory. MicroCentre price £5,326.

But because by doing so we can dedicate our time, energy and resources to giving you the highest standard of Cromemco support possible.

demonstration; expect the full range of Cromemco peripherals; single-user and multi-user systems; and interactive graphics.

Demonstrations

So when you visit MicroCentre expect to find Cromemco systems on permanent

Software

Expect a choice of operating systems and compilers to evaluate; expect complete documentation; and expect the largest collection of Cromemco systems software in the UK.

Expertise

Expect to find in-depth professional expertise at MicroCentre, the kind that is only acquired by installing Cromemco systems all over Britain. Expect a thorough appreciation of how Cromemco systems can be applied . . . in business, scientific research, industrial engineering, medicine and education.

Support

Expect to get frank, accurate answers to your questions at MicroCentre. Above all, once you've bought a Cromemco system from us, expect to get a very high standard of technical support with your hardware enhancements and continuing software needs.

At MicroCentre, simply expect the best.

For Cromemco... call the experts

NOW IN SPACIOUS
NEW SHOWROOMS

Tel. 031-556 7354

Micro Centre

STILL IN
CENTRAL EDINBURGH

Complete Micro Systems Ltd., 30 Dundas Street, Edinburgh. EH3 6JN

● Circle No. 101

Editor
Peter Laurie

Staff Writer
Duncan Scot

Production Editor
Toby Wolpe

Editorial Secretary
Susie Manning

Consultants:
Technical **Nick Hampshire**
Software **Mike McDonald**
Videotex **Peter Sommer**

Editorial: 01-261 8752

Advertisement Manager
Tom Moloney 01-261 8107

Advertisement Executives
David Lake 01-261 8056
Jeff Weinrich 01-261 8057

Midlands office:
David Harvett 021-356 4838

Northern office:
Ron Southall 061-872 8861

Advertisement Secretary
Stephanie Hill

Publisher
Chris Hipwell

Published by IPC Electrical Electronic Press Ltd, Dorset House, Stamford Street, London SE1 9LU, tel 01-261 8000, Telex/grams 25137 BISPRSG
Typesetting and artwork by Bow-Towning Ltd, London EC1
Printed by Eden Fisher Ltd, Southend-on-Sea
Distributed by IPC Sales and Distribution Ltd, 40 Bowling Green Lane, London EC1R 0NE
Subscriptions: U.K., £8 per annum; Overseas £14 per annum; airmail rates available on application to Subscription Manager, IPC Business Press (S & D) Ltd, Oakfield House, Perrymount Road, Haywards Heath, Sussex RH16 3DH, tel 0444 59188

© IPC Business Press Ltd 1980
ISSN 0141-5433

Would-be authors are welcome to send articles to the Editor but PC cannot undertake to return them. Payment is at £30 per published page. Programs intended for publication should ideally be justified to 22 or 44 or 66 characters per line.

Every effort is made to check articles and listings but PC cannot guarantee that programs will run and can accept no responsibility for any errors.

- 41** Editorial/Waiting for Shakespeare
- 42** Feedback/Proud ZX-80 owner; RND functions; Adventure II assessed
- 46** Printout/Latest ZX-80 add-ons; Tandy's pocket computer; British chess machine
- 56** Desktop Plan/The corporate-modelling package from the U.S. analysed by Mike McDonald
- 60** Vector Graphic MZ/An appraisal of the System B, an intelligent micro priced competitively with dedicated word processors
- 64** SuperPet/The CBM 8032 reviewed by Vincent Tseng
- 66** U.S. Election Game/The razzle-dazzle and intrigue of the Presidential election simulated on your micro
- 76** Chess Machine Survey/We look at the chess packages on the market and measure their value for the game's enthusiasts
- 80** Education interview/The Government view of schools computing expounded by Neil Macfarlane, Parliamentary Under-Secretary at the Department of Education and Science
- 82** The Transam Tuscan design story/Input/output circuitry occupies Mike Hughes in this month's instalment
- 88** Statistics on a micro/Owen Bishop demonstrates how the Runs Test can detect significant trends and clustering
- 93** Applications/How a Pet is used in an unexpected way at a gardening centre
- 94** Winchester technology/*Practical Computing* reports on the techniques behind this storage medium
- 100** Recreational maths/We present Frieze Patterns
- 109** Pet Corner
- 113** ZX-80 Line-up
- 117** Tandy Forum
- 119** 6502 Special
- 121** Apple Pie
- 123** Book reviews
- 125** Diary
- 126** Machine code/The sixth part of David Peckett's study of Z-80 and 6502 machine code covers subroutines and the stack
- 133** Computer Buyers' Guide
- 144** The Hexadecimal Kid/Page 1 of the parable in eight virtual pages by Richard Forsyth

MICRODIGITAL
AFTER 106

Prestel page number 45631 / The *Practical Computing* Prestel pages

Wego Computers Ltd



C CBM approved
£59.55 + VAT

Wego Sequential Switching Unit

Allows up to 5 devices to be connected to the mains, and with one switching operation power up and down all the devices, in the correct sequence.



£89.50 + VAT

Numeric Key Pad for the Apple.

A 13 digit Key pad (0-9, -, ., ENTER) to run in parallel with the numeric section of the APPLE Keyboard. Supplied with connecting cable, plugs and sockets.



C CBM approved
Prices from £620 + VAT

Mark Sense Card Reader

"A pencil, a card, and this low-cost reader... it's the new, fast way to enter data into your microcomputer." Versions available able to communicate with PET, APPLE, TRS-80, or any S100 or RS232 bus. Ideal for business and education applications.



S Sole UK Distributors

California Computer Systems Cards for the Apple

| | |
|-----------------------|---------------|
| Synch Serial Card | £119.97 + VAT |
| Asynch Serial Card | £106.37 + VAT |
| Parallel Card | £ 79.97 + VAT |
| Arithmetic Proc. Unit | £265.97 + VAT |
| Programmable Timer | £106.37 + VAT |
| IEEE GPIB | £199.50 + VAT |
| A/D Converter | £ 99.72 + VAT |
| ROM/PROM Module | £ 70.89 + VAT |
| Clock Card | £ 83.33 + VAT |
| Centronics Card | £ 79.97 + VAT |

Available from your local dealers, or direct from Wego Computers Ltd., 22A, High Street, Caterham, Surrey CR3 5UA. Tel: (0883) 49235 Telex: 8813791

Authorised COMMODORE and APPLE Dealers

• Circle No. 102

ELECTRONIC BROKERS LTD VDU PRICES

SHATTERED

£199



HAZELTINE 1000
The low, low priced teletypewriter — compatible video display terminal with 12" screen (12 x 80) 64 ASCII alphanumeric and symbols. Full/Half Duplex. RS-232

ALL EQUIPMENT RECONDITIONED
UNLESS OTHERWISE STATED

£299



HAZELTINE 2000
The world's largest-selling teletypewriter — compatible video display terminal. Features include: 12" screen (74 x 27) 64 alphanumeric and symbols. 32 ASCII control codes. Switch-selectable transmission rates to 9600 baud. Three switch-selectable operating modes full-duplex, half-duplex or batch. Direct cursor addressability. Dual-intensity video. Tabulation. Powerful editing capability. Remote keyboard. Selective or automatic roll-up. RS-232

£425



MODULAR ONE BASIC
12" screen (24 x 80). XY cursor addressing, 64 ASCII alphanumeric & symbols. Dual intensity detachable keyboard. Choice of 8 transmission rates up to 9600 baud. RS232. Range of options including lower case (£35.00), Printer port (£70.00).

MODULAR ONE EDIT
All the above plus full edit capability, tabulation, 8 special function keys + many other features. £695.00.
POLLING MODELS also available — P.O.A.

SPECIAL LOW COST PRINTER OFFER

The famous Teletype 33 printer mechanism including case but no keyboard or electronics. 64 upper case ASCII. Print Speed 10cps. Pinfeed platen.

ONLY £85.00 + VAT (personal callers)
or £115.00 (mail order total)

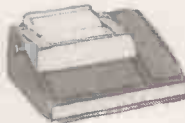

NEW LOW-COST ASCII KEYBOARDS

TTL compatible. ROM-encoded Full 128 ASCII character set Range of spares and accessories Prices from £45.00. Send for full leaflet/price list.

Also available — attractive keyboard enclosures in heavy-duty moulded plastic — manufacturer's surplus Dimensions 17 1/2" wide, 8" deep, 1 3/4" — 4" high.
ONLY £6.00 (mail order total £8.63).



Digitronics 35cps Paper Tape Punch Solenoid — actuated unit capable of punching 5 to 8 channel tapes asynchronously. Basic punch contains 8 data, 1 sprocket and 2 transport solenoids plus end of tape switch. Pulse amplitude 27VDC. Very compact unit measuring only 6 1/2" x 5 1/2", weight 9 1/2 lbs. Price £95.00 (mail order total £115.00).

**WE HAVE MOVED
TO
EXTENSIVE NEW PREMISES**



Electronic Brokers Ltd., 61/65 Kings Cross Road,
London WC1X 9LN. Tel: 01-278 3461. Telex 298694

• Circle No. 103

The Cromemco

Z-2H

THE
MARKET
LEADER

Z-2H
Computer System

Cromemco

**11 Megabytes of hard disc storage in a fast,
new, table-top computer.**

- Fast Z80A 4MHz processor
- 11-megabyte hard disc drive
- Two floppy disc drives
- 64K RAM memory
- RS-232 serial interface
- Printer interface
- Extensive software available

| | |
|-------------|---|
| Camberley | Microbits, Camberley, Surrey 0278 34044 |
| Cambridge | Cambridge Computer Store, Cambridge 0223 68155 |
| Dublin | Lendac Data Systems Ltd., Dublin 372052 |
| Ilford | The Byte Shop, Ilford, Essex 01-554 2177 also at Tottenham Court Road, London 01-636 0647 |
| Leeds | Holdene Ltd., Leeds 0532 459459 also at Wilmslow, Cheshire 0625 529486 |
| London | Digitus Ltd., London W101-636 0105 |
| Manchester | Computer Workshop, Manchester 061-832 2269 also at West Park, Leeds 0532 788466 |
| Newbury | Newbear Computing Store, Newbury, Berks 0635 30505 |
| Newport | Micromedia Systems, Newport, Gwent 0633 50528 |
| Nottingham | Computerland Ltd., Nottingham 0602 40576 also at Birmingham 021-622 7149; Manchester 061-236 4737; Glasgow 041-332 2468 |
| Sheffield | Hallam Computer Systems, Sheffield 0742 663125 |
| Southampton | Xitan Systems Ltd., Southampton 0703 38740 |
| St. Austell | Benchmark Computer Systems Ltd., St. Austell 0726 61000 |



comart specialists in microcomputers

Comart Ltd., P.O. Box 2, St. Neots, Huntingdon, Cambs, PE19 4NY. Tel: (0480) 215005 Telex: 32514

• Circle No. 104

The b



TRS-80 Model I
from £379
4K Level I
£559
16K Level II
(illustrated).

£559.00*
(16K Level II)

TRS 80 Model I Microcomputer Here's the push button brain, the entertainer, the tutor, the timesaver. Fun for the children, a helper for the businessman and the teacher, a catalogue for the housewife, an analyser for the investor and an informer for the salesman. Run Maths, English, Chess, Draughts and video game programmes for educational fun. Easy to learn and operate — you can even write your own programmes. Suddenly you have a ready and reliable source of brainpower — put it to work immediately.



£289.00*

£439.00*

TRS 80 Model I C.P.U.'s Complete and ready to run from your TV monitor. Just plug in and start computing. The lowest priced 4 K level I CPU contains 4096 bytes of user memory and can be expanded to 16K within the keyboard unit. The 16K level II CPU is a more powerful and flexible version using an additional 12K ROM. Level II also incorporates a calculator style numeric keypad for faster data entry.

rains.



RS 80 Model II Microcomputer A bigger, more powerful brother to Model I. Designed for more data storage and versatility. Like Model I is completely modular allowing easy, plug-in expansion. It's available memory will allow maximum use of future languages.

TRS-80 COMPUTER CENTRES NOW OPEN AT—
Birmingham—Edgbaston Shopping Precinct, Hagley Road.
Bradford—214, Forster Square.
Bristol—Colston Centre, Colston Avenue.
London—1-2, Seacoal Lane, Ludgate Hill, EC4.
Manchester—30, Market Place, Deansgate.
Southampton—East Street Centre.

FULL COMPUTER FACILITIES AVAILABLE AT—
Downd—5, Badminton Road, Downend, Bristol.
Leeds—72, Merrion Centre.
Liverpool—168, Market Way, St. Johns Centre.
Wednesbury—Bilston Road.
Wimbledon—124-126, The Broadway, London, SW19.

*All prices include VAT.

IT'S POSSIBLE, ONLY AT Tandy

Better Equipment. Lower Prices. No Middlemen.

SUPERBRAIN

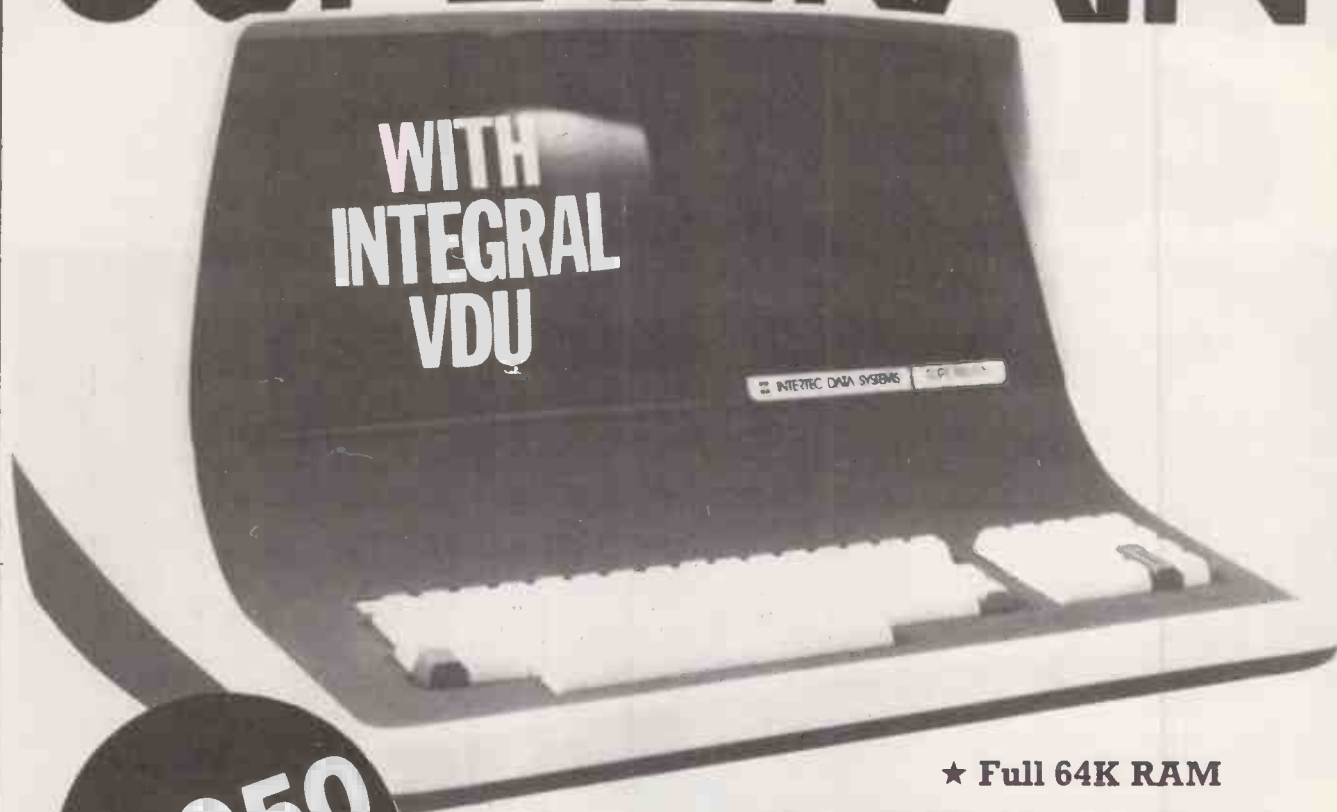

£1,950
COMPLETE
(+VAT)

★ Full 64K RAM

★ Twin Z80A microprocessors

★ CP/M™ (2.2) operating system

★ Twin double density mini floppies (320K:670K optional)

SUPERBRAIN -stand alone system and intelligent terminal combined in a single desk top unit (14³/₈"H x 21³/₈"W x 23¹/₈"D).

Non-glare dynamically focused 12" CRT and Universal RS-232

Communications port. SOFTWARE PACKAGES AVAILABLE.

Full **SUPERBRAIN**
details from the
following dealers:

JAEMMA LTD.,
44 Manor Park Road, Castle Bromwich,
BIRMINGHAM Tel: 021 7474531

JENNINGS COMPUTER SERVICES LTD., 55/57 Fagley Road,
BRADFORD 2, W. Yorks.
Tel: 0274 637867

COMPUTERISED BUSINESS SYSTEMS, 32/34 Humriss Row,
SCARBOROUGH, N. Yorks.
YO11 2ED. Tel: 0723 75787

AERCO GEMSOFT,
27 Chobham Road, WOKING,
Surrey GU21 1JD. Tel: 04862 22881

O. C. T., Kimberley House,
Vaughan Way, LEICESTER,
LE1 4SG. Tel: 0533 28631

SORTFIELD LTD.
E Floor, Milburn House, Dean Street,
NEWCASTLE-ON-TYNE, NE1 1LE.
Tel: 0632 29593

CULLOVILLE LTD., Thornfield,
Woodhill Road, Sandon,
CHELMSFORD, Essex.
Tel: 024 541 3919

PROMGLOW LTD., 12 Dene Road,
New Southgate, LONDON N11 1ES.
Tel: 01-368 9002

SHEFFIELD COMPUTER CENTRE,
225 Abbeydale Road, SHEFFIELD,
S7 1FJ. Tel: 0742 53519

INTERAM COMPUTER SYSTEMS LTD., 59 Moreton Street,
VICTORIA, London SW1.
Tel: 01 834 0261/2733

COSMOS COMPUTERS LTD.,
Blackhorse Road, LETCHWORTH,
Herts. Tel: 046 26 6861

BORDER COMPUTING,
Dog Kennel Lane, BUCKNELL,
Shropshire SY7 0AX. Tel: 05474 368

DAYTA, 20B West Street,
WILTON, Wilts. SP2 0DF.
Tel: 072274 3898

MICRO SOLUTION LTD.,
Park Farm House, Heythrop,
Chipping Norton, OXFORDSHIRE.
OX7 5TW. Tel: 0608 3256

MICROPEOPLE LTD.,
Microcomputer Consultancy Services,
1 Union Street, LONG EATON,
Nottingham, NG10 1HH.
Tel: 06076 68923

RECMA COMPUTING
Chelwood House, Thornbury,
BRISTOL, BS12 2JT. Tel: 0454 775150

OMEGA ELECTRICS LTD.,
Flaxley Mill, Flaxley Road,
MITCHELDEAN, Gloucestershire.
Tel: 045 276 532

AMA (COMPUTING) LTD.,
1 Frog Hall Lane, WARRINGTON
WA2 7JJ. Tel: 0925 33137

ROGIS SYSTEMS LTD.,
Keepers Lodge, Frittenden,
Nr. CRANBROOK, Kent.
Tel: 058 080 310

GARCIA BUSINESS SYSTEMS,
106 High Street, BUSHEY, Herts.
WD2 3DE. Tel: 01-950 6255

ESCO COMPUTING LTD.,
74 Waterloo Street, GLASGOW,
G2 7DA. Tel: 3041 204 18'1

DRAGON SYSTEMS LTD.,
54 Mansel Street,
SWANSEA, West Glamorgan.
SA1 5TE. Tel: 0792 794 786

For dealer enquiries, contact

ICARUS COMPUTER SYSTEMS LTD., 27 Greenwood Place, London NW5 1NN.

CP/M™ is the registered trademark of Digital Research.

SUPERBRAIN SOFTWARE

(other CP/M™ machines supplied)

LANGUAGES

MICROSOFT INC.

| | | |
|---------|-------------|------|
| MBASIC | Interpreter | £195 |
| BASIC | Compiler | £215 |
| FORTRAN | Compiler | £240 |
| COBOL | Compiler | £375 |

MICROFOCUS

| | | |
|-------------|--|--------|
| † CIS-COBOL | | £445 |
| CORAL 66 | | t.b.a. |

WHITESMITHS

| | | |
|-----------------------|-------------------|------|
| † C | | £340 |
| † PASCAL (includes C) | not yet available | £500 |

RESEARCH MACHINES LTD.

| | | |
|------------|--|------|
| * ALGOL 60 | | £110 |
|------------|--|------|

MT microSYSTEMS

| | | |
|--------|----------|------|
| PASCAL | Compiler | £145 |
|--------|----------|------|

VANGUARD SYSTEMS CORP.

| | | |
|-----|-------------|------|
| APL | Interpreter | £190 |
|-----|-------------|------|

tiny c associates

| | | |
|----------|-------------|-----|
| † tiny c | Interpreter | £50 |
|----------|-------------|-----|

DIGITAL RESEARCH INC.

| | | |
|--------|--|------|
| † PL/I | | £300 |
|--------|--|------|

OTHERS

| | | |
|----------------------------------|--|--------|
| MULTI-FORTH (Creative Solutions) | | £75 |
| PILOT | | p.o.a. |

UTILITIES

| | | |
|----------------------------|--|--------|
| * EDIT - 80 (Microsoft) | | £50 |
| * MACRO - 80 (Microsoft) | | £90 |
| FORMS II for CIS COBOL | | £100 |
| * BSTAM (Byrom Softwear) | | £80 |
| SUPERSORT (Micropro) | | £125 |
| HDBS | | t.b.a. |
| MDBS | | t.b.a. |
| MICRO B+ | | £120 |
| MAC (Digital Research) | | £60 |
| ZSID (Digital Research) | | £60 |
| DESPOOL (Digital Research) | | £35 |
| DATASTAR (Micropro) | | £180 |

APPLICATIONS

COMMERCIAL

| | | | |
|-----------|------------------------|---|-------|
| MCS Ltd. | Invoicing | } | £1150 |
| OASIS III | Stock Recording | | |
| | Sales Ledger | } | £950 |
| | Purchase Ledger | | |
| | Nominal Ledger | | |
| | Full Integrated System | | £1950 |

MEDIAN-TEC

| | |
|---------|------|
| Payroll | £500 |
|---------|------|

ROGIS

| | |
|----------------------|------|
| Estate Agents system | £475 |
| Stock Control system | £475 |

WORD PROCESSING

| | | |
|-------------------|------------|------|
| MICROPRO WORDSTAR | £250 | |
| with Mail-Merge | £320 | |
| sb | MAGIC WAND | £200 |

ENGINEERING

MEDIAN-TEC

| | |
|-------------------------------|-------|
| Slope Stability Analysis | £500 |
| Portal Frame Plastic Analysis | £500 |
| 'Decide' Concrete Design pkge | £1500 |
| Finite Element Beam Analysis | £1500 |

ENG ANALYSIS

| | |
|-------------------------------|-----|
| Truss force program | £35 |
| Structural Finite Element -2D | £50 |
| -3D | £75 |

MISCELLANY

| | |
|-----------------------------------|-------------|
| CP/M User Group Library | £6 per disk |
| STATISTICS pkge | £100 each |
| MATH FUNCTION pkge | £150 both |
| MICROSTAT STATISTICS | £150 |
| SIMPLEX method LINEAR PROGRAMMING | £50 |
| EDUCATIONAL SOFTWARE | p.o.a. |
| GAMES PROGRAMS | p.o.a. |



SUPERBRAIN

£1950 incl. CP/M 2.2

£2400 dble sided vn.

Printers from £400

MOST SYSTEMS

under £5000 complete

10% discount on any two software orders exceeding £350
Manuals £10(*) or £20 except †

Prices subject to change without notice **ADD V.A.T.**

Postage and Packing **FREE** on 'Cash-With' Orders

Despatched by **RETURN** whenever possible

Trade Enquiries Welcome.

MicroPeople Ltd.

Telephone: (06076) 69117
1, UNION STREET, LONG EATON,
NOTTINGHAM NG10 1HH.

DO NOT HESITATE TO CONTACT US FOR ANY REQUIREMENT NOT LISTED ABOVE



SUPERBRAIN™

Intelligent Video Terminal Systems

350K or 700K of Disk Storage

SuperBrain's CP/M operating system boasts an overwhelming amount of available software in BASIC, FORTRAN, COBOL, and APL. Whatever your application . . . General Ledger, Accounts Receivable, Payroll, Inventory or Word Processing, SuperBrain is tops in its class. And the SuperBrain QD boasts the same powerful performance but also features a double-sided drive system to render more than 700K bytes of disk storage and a full 64K of RAM. All standard!

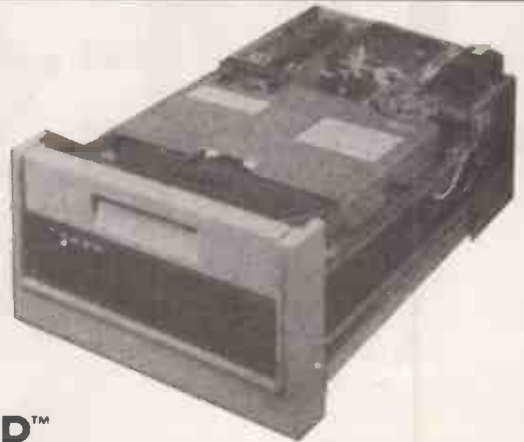

COMPUSTAR™

MULTI-USER TERMINAL SYSTEM

CompuStar user stations can be configured in a countless number of ways. A series of three intelligent-type terminals are offered. Each is a perfect cosmetic and electrical match to the system. The CompuStar 10 — a 32K programmable RAM-based terminal (expandable to 64K) is just right if your requirement is a data entry or inquiry/response application. And, if your terminal needs are more sophisticated, select either our CompuStar 20 or CompuStar 40 as user stations. Both units offer dual disk storage in addition to the desk system in the CompuStar. The Model 20 features 32K of RAM (expandable to 64K) and 350K of disk storage. The Model 40 comes equipped with 64K of RAM and over 700K of disk storage. But, most importantly, no matter what your investment in hardware, the possibility of obsolescence or incompatibility is completely eliminated since user stations can be configured in any fashion you like — whenever you want — at amazingly low cost!

DISK STORAGE

Options for the Superbrain and CompuStar Video Terminal

"Backup" for the 20 megabyte Century Data drive is provided via the dual disk system housed in the CompuStar or the SuperBrain. The Control Data CMD Drive features a removable, front-insertable top loading cartridge of 16 megabyte capacity plus a fixed disk capacity of either 16 or 80 megabytes. Each drive is shipped equipped with an EIA and standard 19" rack mounting system and heavy duty chassis slide mechanisms to permit easy accessibility for fast and efficient servicing.

****** WIDELY USED IN UK AND USE ******
****** TESTED AND PROVEN ******
****** POWER AT YOUR FINGERTIPS ******
****** JUST COMPARE THIS LIST ******

NO OTHER PROGRAM IN THE WORLD COMBINES THESE FEATURES IN ONE.

many other programmes, LESS INTEGRATED, DO NOT PROVIDE EVEN SOME OF THOSE FEATURES TO BE FOUND ON OUR 'BUS'.

- 1 = TOTAL INTEGRATION OF SALES/PURCHASE/NOMINAL/STOCK/ADDRESSES/ETC.
- 2 = FULL RANDOM ACCESS ENABLES RETRIEVAL OF ANY RECORD IN A SECOND
- 3 = FLEXIBLE PROMPTS ENABLES WORD CHANGE EVEN TO FOREIGN LANGUAGE
- 4 = FILES MAY BE DEFAULT NAMED AND LOCATED FOR FULL DISK USAGE
- 5 = EASY TO USE, MENU DRIVEN, NO SERIOUS NEED OF MANUAL
- 6 = TESTED AND DEBUGGED IN MANY INSTALLATIONS WORLD-WIDE
- 7 = PRICED LESS THAN THE ACQUISITION OF A LIBRARY OF PROGRAMS
- 8 = THE PROGRAM IS ***TOTALLY*** IN CORE, MAXIMISING DISK SPACE
- 9 = CORE PROGRAM MEANS THAT DISKS MAY BE INTERCHANGED DURING USE
- 10 = CORE PROGRAM MEANS YOU USE THE FIRST SYSTEM DRIVE YOU PAID FOR
- 11 = NUMEROUS REPORTS MAY BE GENERATED (EG: SALE LEDGERS UP TO 30)
- 12 = INVOICE PRODUCES IMMEDIATE STOCK UPDATE + DOUBLE JOURNAL ENTRY
- 13 = REFERENCE ON INVOICES ENABLE COST CENTRE BUILD-UP ON LEDGERS
- 14 = STOCK VALUATIONS AND RE-ORDER REPORTS EASILY GENERATED
- 15 = BANK BALANCE AND REPORTS PLUS STANDARD MAILING FACILITIES
- 16 = CUSTOMER STATEMENTS AND INVOICES PRINTED ON PLAIN PAPER

WE EXPORT TO ALL COUNTRIES

CALLERS ONLY BY APPOINTMENT

***** MAIN MENU DISPLAY *****

NEW! PRODUCED IN U.K. AND WIDELY USED IN ENGLAND AND U.S.A.
COMPLETE BUSINESS PACKAGE

INCLUDES EVERYTHING FROM INVENTORY TO SALES SUMMARY PROMPTS USER AND VALIDATES ENTRIES. MENU DRIVEN

BUS VER 3.00 TO VER 9.00 PET AND CP/M
APPROXIMATELY 60-100 ENTRIES/INPUTS REQUIRE 2-4 HOURS WEEKLY
AND ENTIRE BUSINESS IS UNDER CONTROL

* PROGRAMS ARE INTEGRATED.. SELECT FUNCTION BY NUMBER.

- | | |
|-------------------------------------|--|
| 01 = *ENTER NAMES & ADDRESSES | 13 = *PRINT CUSTOMERS STATEMENTS |
| 02 = *ENTER/PRINT INVOICES | 14 = *PRINT SUPPLIER STATEMENTS |
| 03 = *ENTER PURCHASES | 15 = *PRINT AGENT STATEMENTS |
| 04 = *ENTER A'C RECEIVABLES | 16 = *PRINT TAX STATEMENTS |
| 05 = *ENTER A'C PAYABLES | 17 = GENERAL HELP |
| 06 = *ENTER 'UPDATE INVENTORY | 18 = ALTER VOCABULARIES |
| 07 = ENTER 'UPDATE ORDERS | 19 = PRINT YEAR AUDIT |
| 08 = *ENTER 'UPDATE BANKS | 20 = PRINT PROFIT 'LOSS A'C |
| 09 = *REPORT SALES LEDGER | 21 = ENDMONTH MAINTAINANCE |
| 10 = *REPORT PURCHASE LEDGER | 22 = PRINT CASHFLOW FORECAST |
| 11 = *INCOMPLETE RECORDS | 23 = ENTER PAYROLL (NO RELEASE) |
| 12 = *EXAMINE PRODUCT SALES | 24 = EXIT SYSTEM |

ENTER WHICH ONE?

DATABASE MANAGEMENT INCLUDES

*** FILE CREATE/DELETE/SEARCH. *** RECORD CREATE/DELETE/SEARCH/4 OPTION PRINT.
*** RECORD SORT ANY FIELD ALPHA OR NUMERIC. *** INDEX SEARCH OR GENERAL SCAN/PRINT IN ANY FIELD
(EG TOWN OR NAME). *** 4 ARITHMETIC FUNCTIONS TO USE AS CALCULATOR ON LAST 4 FIELDS. *** AUTO CHECK
TO PREVENT DOUBLE ENTRY TO FILE MANAGEMENT SYSTEM, DYNAMICALLY ALLOCATING INFORMATION TO MINIMISE
DISK SPACE CONSUMPTION.

VERY FLEXIBLE. EASY TO USE

G.W. COMPUTERS U.K. ARE THE PRODUCERS OF THIS BEAUTIFUL PACKAGE

VER 3.00 (EXC PROG 19,20,22,23) = 475.00, VER 4.00 INCLUDES AUTO STOCK-UPDATE = 575.00,
VER 5.00 INCLUDES AUTO BANK UPDATE = 675.00, VER 6.00 IN CORE = 775.00, VER 7.00 (INC 19,20,22,23)
NOT YET RELEASED = 875.00, VER 8.00 RANDOM ACCESS = 900.00, VER 9.00 TRANSLATEABLE = 975.00.
+ + + EACH LEVEL OVERRIDES LOWER ONE

IMPORTANT!!!

WE ALSO SELL THE HARDWARE FOR THE ABOVE TASKS TO ENABLE THE PURCHASE FROM ONE SOURCE.
NOTE THAT A *** COMPLETE *** CBM SYSTEM WITH BUS VER 3 IS 2215 POUNDS AND A *** COMPLETE *** SUPERBRAIN
SYSTEM WITH BUS VER 3 AND DEC PRINTER IS 3345 POUNDS.

| | | | |
|--------------------------------|-----------------------------|-------------------------|-------------------|
| PET + PET + PET + PET + PET | SOFTWARE + SOFTWARE | SUPERBRAIN 700K | 2300.00 |
| CBM 3032 32K 650.00 | BUS VER 3.00 475.00 | TWIN Z80 64K + CRT | |
| CBM 3040 DISKS 650.00 | BUS VER 4.00 575.00 | + 2 D'D - D'S DRIVE | |
| CBM 3022 PRINTER 425.00 | BUS VER 5.00 675.00 | M'USER S'BRAIN | 1850.00 - 2750.00 |
| CBM 8032 32K 875.00 | BUS VER 6.00 775.00 | LINKS UP TO 16-96 | |
| CBM 8050 1MEG DISKS 875.00 | BUS VER 7.00 875.00 | SUPERBRAINS ON | |
| CBM EPSON PRINTER 395.00 | BUS VER 8.00 900.00 | MULTI TASKING | |
| CBM MULTI USER 650.00 | BUS VER 9.00 975.00 | COMPUSTAR | |
| CBM 3032 + EPSON + | CBM WORDPRO II 75.00 | 16 MEG ADD-ON | 3950.00 |
| CBM 3040 + BUS V3 2215.00 | CBM WORDPRO III 150.00 | S'BRAIN HARD DSK | |
| PRINTERS + PRINTERS + PRINTERS | CPM WORD-STAR 250.00 | INTERTUBE III | 450.00 |
| DIABLO 1650 40CPS 2150.00 | CPM MBASIC 80 150.00 | EMULATOR TERM'L | 495.00 |
| DOLPHIN 125CPS BD80 495.00 | CPM COBOL 80 320.00 | NEW MULTI TERM'L | |
| OKIDATA MICROLINE 575.00 | CPM PASCAL MT 150.00 | SUPERBRAIN + SUPERBRAIN | |
| PAPER TIGER 195CPS 575.00 | CPM FORTRAN 80 200.00 | SUPERBRAIN 32K | 1695.00 |
| TELETYPE 43SR 30CPS 875.00 | CPM DATASTAR 175.00 | TWIN Z80 64K + CRT | |
| DEC-LA34 TRACT 30CP 875.00 | CPM PASCAL-M 250.00 | + 2 D'D - S'S DRIVE | |
| NEC-SPINWRITER 1595.00 | CPM BYSTAM S'BRAIN 75.00 | INCLUDES £150 | |
| QUME DAISY SPRINT5 1950.00 | CPM SUPERSORT 120.00 | SOFTWARE FREE | |
| TEXAS 810 150CPS 1390.00 | CPM BASIC COMPILER 190.00 | | |
| SPECIALS + SPECIALS + SPECIALS | CPM DESPOOL 30.00 | TANDY MODEL II | 1950.00 |
| N'STAR QUAD. 7MEG 1500.00 | CPM BYSTAM IMS'N-STAR 75.00 | APPLE II 16K | 675.00 |
| IMS 5000 48K D'D 1500.00 | CPM TEXTWRITER 75.00 | COMPUCOLOR 32K | 1750.00 |
| COMPUTHINK * 800K * 795.00 | CPM POSTMASTER 75.00 | IEEE TO RS232 | 150.00 |
| 2 WAY CORDLESS PHONE 135.00 | CPM SELECTOR 3 180.00 | IEEE TO PARALLEL | 160.00 |
| TELEPHONE ANSWER 230.00 | CPM CBASIC 75.00 | IEEE RS232 B'DI | 195.00 |
| SHUGART SA400 DRIVE 54" 135.00 | CPM MACRO 80 75.00 | IEEE MODEM | 295.00 |
| | CPM W'STAR M'MERGE 310.00 | CAT MODEM | 135.00 |
| | | 6 MONTH WARRANTY | |

+ + + + + SPECIAL INSTITUTION AND UNIVERSITY DISCOUNTS + + + + +
STOCK AND COMING ROUND. (BARCLAYCARD WELCOME OTHERWISE CHEQUE WITH ORDER)
CONTACT TONY WINTER 01.636.8210
89 BEDFORD CT MANS, BEDFORD AVE W.C.1.

The Strong Silent Type



- Line printer quality at character printer price.
- 300 lines per minute.
- Serial or parallel interface.
- Centronics or Dataproducts Compatible.
- Electronic Vertical Forms Control.
- Highly efficient sound reducing cabinet.

OEM PRINTERS FROM

KODE

Station Road, Calne, Wiltshire SN11 0JR.
Telephone Calne (0249) 813771. Telex 449335

• Circle No. 108

DYAD Developments are pleased to announce that they have been appointed UK Distributors of **COMPUCOLOR II**

The Compucolor Corp. are now supplying them with their up to date systems and these have been found to be exceptional in performance and reliability. These second generation machines represent the most sophisticated and powerful small computers available today and at only half the cost of their counterparts.

COMPUCOLOR II

DEALER INQUIRIES WELCOME

Keyboard

Separate keyboard with Standard ASCII 4 level, coded with 192 codes. Includes 71 gold crossbar commercial key switches. CPU Reset and Automatic disk loading (AUTO) keys are included. Optional: 101 keys with colour and numeric clusters or 117 keys with 16 additional function keys.

Microcomputer

Central Processing Unit: 8080A, 2 microsecond cycle time with total memory expandable to 64K bytes. Read Only Memory (ROM): 16K bytes of non-destructive read only. Memory sockets included for 8K bytes of additional EPROM/MROM memory. Includes DISK BASIC, File Control System, and Terminal Software. Random Access Memory (RAM): 4K bytes for screen refresh. 8K bytes for user workspace. (Optional 16K and 32K — Models 4 and 5.)

Input/Output Ports: system is designed for 478 ports, with 30 ports implemented in standard unit. Including one RS-232C Serial Asynchronous Channel for a printer or modem.

50 pin bus: provides all addresses, data, clocks, etc., to allow the Compucolor II to be expanded with additional peripherals in the future.

CRT Terminal Commands: Page/Roll Mode; Erase Line; Erase Page; Tab; Two Character Sizes; Blink; Cursor Home, Left, Right, Up and Down; Cursor XY Addressing; Caps Lock; CPU Reset; Foreground/Background Color Selection; 15 Plot Modes; Blind Cursor Mode; Local, Full and Half Duplex Modes; Write Vertical Mode; and Transmit Cursor and Page Modes.

Language: DISK BASIC 8001 interpreter in ROM memory Includes: 29 statement types: CLEAR, DATA, DEF, DIM, END, FILE, FOR, GET, GOSUB, GOTO, IF, INPUT, LOAD, NEXT, ON, OUT, PLOT, POKE, PRINT, PUT, READ, REM, RESTORE, RETURN, SAVE, STEP, THEN, TO and WAIT. 3 command types: CONT, LIST and RUN. 19 mathematical functions: ABS(x), ATN(x), CALL(x),



- * 13" COLOUR MONITOR for COLOUR GRAPHICS etc
- * Built in MINIFLOPPY DRIVE 51.2K per side
- * Impressive EXTENDED BASIC on 16K ROM
- * HIGH RESOLUTION GRAPHICS 128 x 128
- * RS232C port simplifies PRINTER or MODEM atch.

COS(x), EXP(x), FN(x,y), FRE(x), INT(x), INP(x), LOG(x), PEEK(x), POS(x), RND(x), SGN(x), SIN(x), SPC(x), SQR(x), TAB(x), and TAN(x). 9 string functions: ASC(x\$), CHR\$(x), FREI(x\$), LEFT\$(x\$,I), LEN(x\$), MID\$(x\$,I,J), RIGHT\$(x\$,I,J), STR\$(x) and VAL(x\$). 12 Disk File commands: COPY, DELETE, DEVICE, DIRECTORY, DUPLICATE, INITIALIZE, LOAD, READ, RENAME, RUN, SAVE, and WRITE.

CRT Display

Eight color display with 32 lines of 64 characters (2048 characters). Two different character sizes. Plotting graphics of 128 x 128, including vector generating software. 64 standard ASCII characters and 64 additional special graphic characters. Includes a Standard RS232C Terminal Mode for time sharing use. 60Hz refresh. Usable screen area 9" wide x 6 3/4" high.

Compuwriter — The Compuwriter was designed specifically for the Compucolor II and the ISC 3621. This package includes the necessary keyboard conversions, documentation, and software to turn your computer into a powerful text editing machine. Compuwriter incorporates the best features of the leading word-processing systems including single key command entry, full screen editing and print formatting on the screen.

Trendspotter — The Trendspotter software package is a "state-of-the-arts" management information system which fully utilizes our products colorgraphic capabilities. Data is entered and stored on files created by the user. Trendspotter will automatically scale the data to fit within the graphic display. The display can be labelled according to the users needs and the various files plotted in any of the eight foreground or background colors for comparative analysis. Four graphic modes are available and data can be manipulated to account for lag and lead times, trend forecasting, exponential smoothing, simple linear regressions, moving averages, compound growth calculations, inflation and deflations compensation, detrending of data, and "trigger point" functions.

prices excl. VAT

| | |
|-------------|-------|
| 8K User RAM | £ 998 |
| 16K " " | 1078 |
| 32K " " | 1198 |

GAMES

Formatted Twin Pack
Sampler
Othello
Chess
Star Trip
Blackjack
Cubic Tic Tac Toe
Sharks
Air Raid
Star Trader
Swarms
Bounce
Shoot
Lunar Lander
Solitaire
Maze Master

KEYBOARD UPGRADE
101-117
MAINTENANCE MANUAL

SYSTEM/UTILITY

Assembler
Text Editor
Data Base Systems
Basic Utilities
Monitor
Screen Editor
Formatter
MLDP
Fortran
Macro Assembler
Info-Link

EDUCATIONAL

Hangman
Math Tutor
Basic Language 1-10
Basic Language 11-15

ENGINEERING

Statistics-I
Statistics-II
Statistics-III

BUSINESS

Word Processor
Trend Spotter

MISCELLANEOUS

HARDWARE
ADD-ON DISK DRIVE
RS232 ADAPTOR CABLE
LOWER CASE
CHARACTERS
ADD-ON RAM, 16K
ADD-ON PROM BOARD
SOUNDWARE
KEYBOARD UPGRADE
72-101
KEYBOARD UPGRADE
72-117

DYAD Developments The Priory - Great Milton - Oxon - OX9 7PB - Tel (08446) 729

• Circle No. 109

INNOVATIVE

TRS-80 SOFTWARE

FROM THE PROFESSIONALS

PROZAP

THE 3rd GENERATION ZAP!

First there was Superzap*, with plenty of commands but written in Basic. Then Z80zap with the greater speed of machine language but a little short on commands. Now Prozap combines the speed of machine language with a large library of commands. And it has an important feature which the others did not have - the ability to access "protected" disks which its predecessors could not touch. Any unusual sector numbers are no problem to Prozap, nor are 35, 40 or 77 track disks. Here is a list of the most important of Prozap's commands. Don't forget that it is called from DOS direct and it is really fast!

Command Level:

1. Display any sector.
2. Automatically load the Directory track.
3. Enter a DOS command, execute and return.
4. Recall the Buffer.
5. Display the disk statistics of a file.
6. Go direct and display a file by sector.
7. Copy a disk.
8. Go to Debug and return to Prozap.
9. Disable the disk system usage.
10. Encipher a Password.
11. Read any track into memory so that the contents of it may be examined, including the sector layout and other data.

Display Level:

1. Hexadecimal or ASCII modify mode.
2. Page to previous or next sector.
3. Jump to a specified byte.
4. Display same track & sector, different drive.
5. Output a sector.
6. Zero all or part of a sector.
7. As above but with any non zero byte.
8. Search for a byte or search for a word.
9. Display Hash Code and its correct position.
10. Go direct into file display mode.
11. Print a sector on the line printer.
12. Page to a new track or sector.
13. Save a sector to memory.
14. Load buffer from memory.
15. Match the current sector with another.

Display is in hex and ASCII with a linking cursor for ease of use. Written by Nigel Dibben and in our opinion by far the best program of its kind on the market. Supplied on disk.

*ZAP - a colloquialism (American) meaning a computer program which has the ability to access magnetic storage disks for investigation or modification. Derivation unknown.

£ 19.95

PLUS 15% VAT = £22.94. Postage & packing 75P.

Comprehensive Instruction Manual included.

Send large SAE (38p) for our current Catalogue of TRS-80 software. Add £1.85 for a binder.

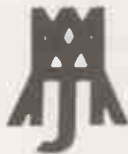

A.J.HARDING (MOLIMERX)

MOLIMERX LTD.

28 COLLINGTON AVENUE, BEXHILL-ON-SEA, E.SUSSEX.

TEL: (0424) 220391

TELEX 86736 SOTEX G



• Circle No. 110



Small Systems Engineering Limited

IEEE-488/PET INTERFACES

NEW ...

TYPE B200 Bi-directional serial interface £186
C.B.M. Disk compatible, software selectable Baud rates, switchable code conversion, RS 232C input and output handshake.

Type C £120
Serial interface - output only
PET disk, compatible, RS232 C Handshake (Printer Busy), switch selectable Baud rates, Listen Address link selectable.

All type C interfaces now incorporate switchable code conversion to match print to PET screen display.

Type G.P.I. A.P. £249
Micro-based, bidirectional with buffering. The General Purpose Interface allows free use of PET's INPUT # statement without hangup problems. Software changeable BAUD rates optional features include: Second Serial 20 mA Loop I.O.

Addressable parallel (disc compatible) for Centronics, Anadex etc. £106

With switchable code conversion. £45

Non addressable parallel £35

TV/Video monitor interface £35

S100 BOARDS

Dynamic Memory Boards

IEEE-S100 Specification Timing
Transparent on Board Refresh
Bank Size to 64K in 16K increments

| Size | Standard | Bank Select |
|------|----------|-------------|
| 64K | £449 | £595 |
| 48K | £398 | £539 |
| 32K | £346 | £483 |

NEW ...

GPI SC

Serial IEEE-488 Bus controller which accepts commands and data in RS232C serial format
Permits any computer or terminal with RS232C I.O. capability to function as a controller in an IEEE-488 Bus system.

P&T IEEE-488 Interface

Provides S100 computers with IEEE-488 Controller, Listener, Talker, Capability £350

SOFTWARE

PETE PET intelligent terminal package £200

NEW ...

BISYNC 80

IBM 3780 emulation software for CPM Micros £425

Please note our new address and phone number!

2-4 Canfield Place · London · NW6 3BT
Telephone: 01 328 7145/6 · Telex 9813006 (Abacus)

• Circle No. 111

APPLE/ITT LETTERWRITER

The unique Guestel 360 letter writer combining text editing facilities with advanced mailing list and associated attributes file. An elegant machine code program with the following features — vertical scrolling, field, tab stops, paragraph indent, alphabetical sorting, string search, right justification, full editing facilities and much more.

Displays in upper and lower case using our own plug-in lower case board.

£230 complete with plug-in lower case board.

£190 for those people who already have an LCB.

BUY THE COPYRIGHT £500

That's right — an unprecedented offer — buy the right to reproduce the program as many times as you want for one small lump sum. Thereafter it's all profit — invest in the future. The applications are endless for a flexible database/text editor — Estate agents, Rental companies, Marketing agencies, Accountants, Clubs and Associations. The market is big enough for everyone — that's why we are prepared to sell it.

All prices ex VAT and pp

GUESTEL LIMITED

REFUGE HOUSE, 2-4 HENRY ST., BATH BA1 1JT.
TEL: (0225) 65379

• Circle No. 112

ANGLIA COMPUTER CENTRE

MICROCOMPUTERS FOR BUSINESS, EDUCATION AND HOME

NO.1 FOR ALL YOUR BUSINESS; EDUCATION & LEISURE COMPUTER REQUIREMENTS!!!

APPLE
ACORN
NORTH STAR HORIZON
NASCOM
TANDY TRS-80
SHARP
U.K. 101
TANGERINE
SORCERER
+ PRINTERS &
OTHER PERIPHERALS
+ ALL BUSINESS
SOFTWARE
+ BUSINESS SEMINARS
AND EVENING CLASSES
+ FREE CONSULTANCY

WE ARE HERE!!!
88 St. Benedict's Street
NORWICH NR2 4AB
Tel. (0603) 29652
24hr. Answering Service.

**BOOKS
SOFTWARE
MAGAZINES
COMPUTER STATIONERY**

• Circle No. 113

PO Box 2
St Neots
Cambridgeshire

Dear Sir

The benefits of word processing are here for all!

The **Comart VDM** Video Display Module plugs easily into the North Star Horizon Computer S100 Bus and, together with the Comart Monitor and VDM *Star word processing software, provides the facilities of "instant display" word processing on a general purpose microcomputer.

Text may be entered, edited and standard paragraphs inserted with true upper & lower case display then rapidly printed in your chosen format.

The VDM transforms the Horizon into a valuable word processor yet change the diskette software and it resumes its role as a general-purpose Computer **Real Flexibility!**

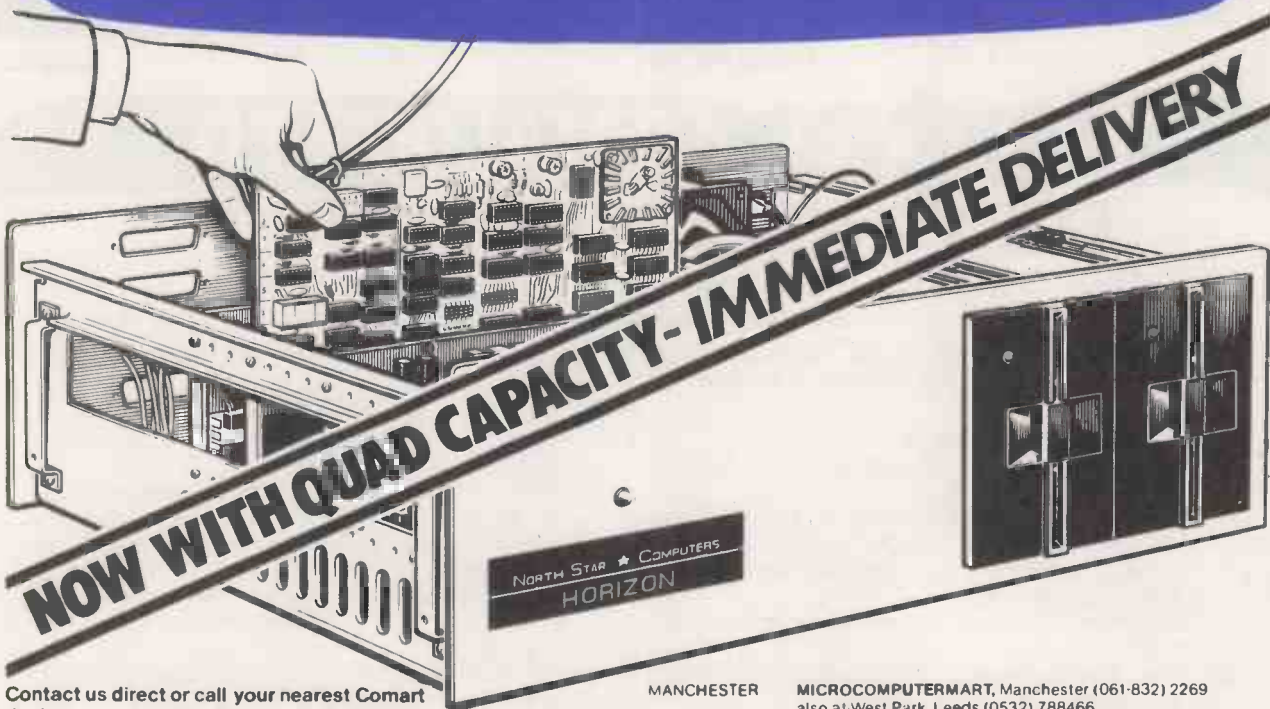

Contact us direct or call your nearest Comart dealer

CAMBRIDGE
CAMBERLEY
ILFORD

LEEDS

LONDON
LUTON

CAMBRIDGE COMPUTER STORE, Cambridge (0223) 68155
MICROBITS, Camberley, Surrey (0276) 34044
THE BYTE SHOP, Ilford, Essex 01-554 2177
also at Tottenham Court Road, London 01-636 0647
HOLDENE LIMITED, Leeds (0532) 459459
also at Wilmslow, Cheshire (0625) 529486
DIGITUS LIMITED, London W1 01-636 0105
ISHERWOODS, Luton, Bedfordshire (0582) 424851

MANCHESTER

NEWBURY

NEWPORT
NOTTINGHAM

SHEFFIELD
SOUTHAMPTON

MICROCOMPUTERMART, Manchester (061-832) 2269
also at West Park, Leeds (0532) 788466

NEWBEAR COMPUTING STORE, Newbury, Berks (0635) 30505
also at Stockport, Cheshire (061-491) 2290

MICROMEDIA SYSTEMS, Newport, Gwent (0633) 50528
COMPUTERLAND LIMITED, Nottingham (0602) 40576
also at Birmingham (021-622) 7149
Manchester 061-236 4737
Glasgow (041 332) 2468

HALLAM COMPUTER SYSTEMS, Sheffield (0742) 663125
XITAN SYSTEMS LIMITED, Southampton (0703) 38740



comart specialists in microcomputers

Comart Ltd., P.O. Box 2, St. Neots, Huntingdon, Cambs, PE19 2AF. Tel: (0480) 215005 Telex: 32514

• Circle No. 114

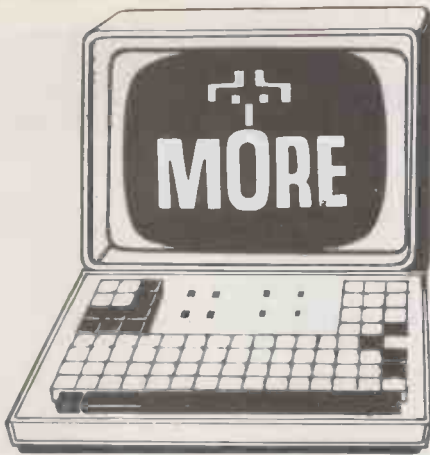

If your PET is hungry for 5¼" flexible disks, we can feed him.

Control Dataset high quality 5¼" flexible disks are readily available at major office equipment suppliers. Or you can order them direct from us.

For a list of stockists, or details of our mail order service, contact us at Control Dataset Ltd., P.O. Box 16, Argyle Way, Stevenage SG1 2AB, Herts. (Tel: 0438-3399)

**CONTROL
DATASET**

CONTROL DATA

• Circle No. 115

MONITORS MONITORS MONITORS

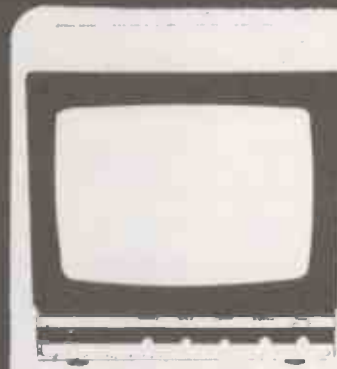

UNCASED 9"
UNCASED 12"
CASED 9"
CASED 10"
CASED 12"
MONITOR TUBES

SELF CONTAINED MONITOR PCB's

CROFTON ELECTRONICS

Crofton Electronics Limited
35 Grosvenor Road, Twickenham, Middlesex.

Tel: 01 891 1513

• Circle No. 116

Intex DATALOG LTD

COMPUTERS

INTEX DATALOG LTD., Eaglescliffe Industrial Estate, Eaglescliffe, Stockton. Tel. 781193

MICROPAY-200

Micropay-200 is a complete payroll System designed to run on a COMMODORE 32K PET microcomputer, interfaced to dual floppy disk drives and a printer.

The System provides:

1. Weekly/monthly payslips
2. Summary page of all payments and deductions that month
3. Summary page of all payments and deductions for the tax year to date
4. Weekly/monthly cash analysis slip for all cash payments made
5. Monthly summary of all payments and deductions
6. Year end summary of all payments and deductions

The System copes with:

1. Up to 200 current employees, plus end of the year details of up to a further 400 ex-employees who have left during the year
2. Suffix L,H,P,V and T cumulative and Week 1 Codes
3. Prefix D and prefix F, BR and NT codes

4. All necessary alterations concerned with changes in income tax rates, band widths and personal allowances
5. National Insurance Contributions at rates A, B and C for contracted out employees and at rates D and E for non-contracted out employees
6. All necessary alterations concerned with changes in N.I. contribution rates and earnings limits
7. UP to 5 user-definable wage rates for each employee, plus the normal hourly rate
8. Holiday pay — including a check on the amount of holiday taken in the year
9. Up to a total of 5 user-definable additions/deductions to the before/after tax pay
10. Changing an employee from one N.I. rate to another and backdating such a change
11. Job costing and analysis

Intex

• Circle No. 117

DATRON of SHEFFIELD

for

Cromemco the ultimate name in micros



DATRON import direct from Cromemco, California.
 DATRON can supply Nationwide.
 DATRON can provide maintenance nationally
 DATRON can give you the realistic prices.
 DATRON have in stock:-

SYSTEM2 64 K £ 2095

SYSTEM3 64 K £ 3746

Z-2H HARD DISC 10 M £ 5373

DATRON can supply Systems 2 and 3 with Multi-Tasking facilities.

DATRON easily accessible - in the centre of the country.

Write or telephone for FREE colour brochure on System 3 or Z-2H.

We use Cromemco for our own business, why not call in for a demonstration.

Demonstrations. 9am-5pm Monday-Saturday.



BOOKS from DATRON

all books in stock at press date

| | | |
|--|--------------------|--------|
| The BASIC Handbook | David Lien | £11.00 |
| Illustrating BASIC | Donald Alcock | £2.50 |
| Basic BASIC | Donald M. Munro | £2.00 |
| The Little Book of BASIC Style | Nevison | £5.75 |
| Some Common Basic Programs | Osborne | £7.95 |
| 32 BASIC Programs for the PET | Rugg & Feldman | £9.75 |
| A guide to BASIC Programming | Spencer | £8.85 |
| A guide to PL/M Programming | McCracken | £7.95 |
| PASCAL An Intro. to Methodical Prog. | Findlay & Watt | £4.95 |
| Introduction to PASCAL | Welsh & Eider | £6.95 |
| Programming in PASCAL | Grogono | £6.95 |
| Primer on PASCAL | Conway et al | £7.10 |
| Struct. Prog. & Problem Solving with PASCAL | Kieburz | £8.40 |
| Problem Solving using PASCAL | Bowles | £7.95 |
| An Introduction to Programming and Problem Solving with Pascal | Schneider | £5.20 |
| COBOL for Business Applications | Philippakis | £10.25 |
| COBOL with Style | Chmura & Ledgard | £5.40 |
| Learning COBOL Fast | de Rossi | £6.45 |
| FORTRAN Techniques | A. Colin Day | £2.95 |
| FORTRAN Fundamentals | J. Staingraber | £3.45 |
| Problem Solving & Struct. Prog. in FORTRAN | Friedman & Koffman | £9.95 |
| An Intro. to Prog. & Applications with FORTRAN | Hull & Day | £8.45 |
| Z80 Micro Handbook | W. Barden | £6.95 |
| Z80 Programming for Logic Design | Osborne | £6.30 |
| Z80 Micro. Prog. & Interfacing Bk 1 | Nichols & Rony | £7.75 |
| Z80 Micro. Prog. & Interfacing Bk 2 | Nichols & Rony | £8.50 |
| Z80 Instant Programs | J. Hopton | £7.50 |
| Z80 Programs (cassette) | | £10.00 |
| Z80 Assembly language Prog. | Leventhal | £8.15 |
| Z80 Programming for Logic Design, Programming the Z80 | Osborne | £6.30 |
| Mostek Z80 Micro Software Programming Guide | Zaks | £8.95 |
| 6502 Assembly language Prog | Leventhal | £6.00 |
| 6502 Applications Book | Sybox | £8.25 |
| | | £8.95 |

| | | |
|---|--------------------|--------|
| Programming the 6502 | Zaks | £7.95 |
| Programming a Micro (6502) | Foster | £7.25 |
| PET Work Books Vol. 1-6 | | £18.00 |
| 6502 Assembly Language Programming. | Leventhal | £8.25 |
| The Best of Micro, Vol. 1 | | £5.50 |
| Vol. 2 | | £6.50 |
| The PET Revealed | | £10.00 |
| Intro. to Personal & Business Computing | Zaks | £5.45 |
| Peanut Butter & Jelly Guide to Micros | Willis | £6.45 |
| A Career in Computing | Penney | £4.25 |
| Philips Guide to Bus. Computers & the Electronic Office | Enticknap | £3.50 |
| Computer Games | Nahigian & Hughes | £8.40 |
| Basic Computer Games | Creative Computing | £5.50 |
| More Basic Computer Games | Creative Computing | £5.50 |
| Game Playing with BASIC | Spencer | £5.50 |
| How to Build a Computer Controlled Robot | Loofbourrow | £5.95 |
| TTL Cookbook | Lancaster | £7.15 |
| CMOS Cookbook | Lancaster | £7.50 |
| TV Typewriter Cookbook | Lancaster | £7.25 |
| Cheap Video Cookbook | Lancaster | £4.95 |
| Best of Byte | | £8.45 |
| Best of Creative Computing Vol. 1 | | £6.95 |
| Best of Creative Computing Vol. 2 | | £6.95 |

P&P free U.K. Overseas add £1

Phone in your Access
 Barclaycard No
 0742 585490
 or complete this
 order form

Send s.a.e. for full list. Prices correct at going to press. Add 12p insurance on books if required.

Please supply

I enclose - £
 Cheque/Postal Order No.

Barclaycard/Access No.

Name:

Address:

DATRON MICRO CENTRE
 DATRON INTERFORM LTD

2 Abbeydale Road, Sheffield S7 1FD.
 Telephone 0742-585490. Telex 547151.

• Circle No. 118

IF . . . you want the best service
 you need professional advice
 years of experience impress you
 you are trying to find the best computer equipment
 as well as the finest software . . .

MICROSOLVE

is the Company to contact

We cover a full range of equipment including the **APPLE II** (from £695/16K); the **MICROSTAR** multi-user system (from £4,950) and the powerful **ALPHA MICRO** which will run 1 to 22 terminals — the most cost effective system available today.

WE OFFER A COMPLETE SERVICE which encompasses advice, systems design, sale and installation of computer and peripherals, as well as tailor-made software, where necessary. There are fully documented **ACCOUNTING** and **WORD PROCESSING PACKAGES** etc., for **ACCOUNTANTS, SOLICITORS, MANUFACTURERS, RETAILERS, MEDICAL PRACTITIONERS** in fact all business applications.

ALSO in stock are **PRINTERS, VDUs, CONTINUOUS STATIONERY, DISKETTES, DISK BOXES**, all from the best names in the computer world — **TEXAS, LEAR SEIGLER, TALLY, QUME, PAPER TIGER** etc.

So if you either wish to buy a computer to program yourself or take advantages of our service — TELEPHONE NOW FOR AN APPOINTMENT.

MICROSOLVE COMPUTER SERVICES LTD.

3rd Flor (rear), MIDDLESEX HOUSE,
 29-45 High Street, EDGWARE, Middlesex.
 01-951 0218/9/0

(exit 4 M1/20 mins. West End). prices ex. VAT.

• Circle No. 119

V. & T. ELECTRONICS

NASCOM 2 microcomputer

READY BUILT & TESTED £250.00

Please note that the 8K Basic will not function without expansion RAM

NASCOM RAM BOARD TYPE 'B'

Holds up to 48K with 16K dynamic RAM ready built & tested

£150.00

3A POWER SUPPLY

£34.50

Ready built & tested

8A POWER SUPPLY

£105.00

Ready built & tested

NASCOM IMP PRINTER £325.00

60 lines per minute 80 characters per second

MEMORY

8 × 4116 200 ns D RAM **£30.00**

1 + 2708 450 ns EPROM **£5.00**

1 × 2516 450 ns EPROM 5V **£12.50**

PLEASE ADD V.A.T. AT 15%

**82 CHESTER ROAD,
 LONDON N19 5BZ**

TELEPHONE 01-263 2643

• Circle No. 120

NEW!

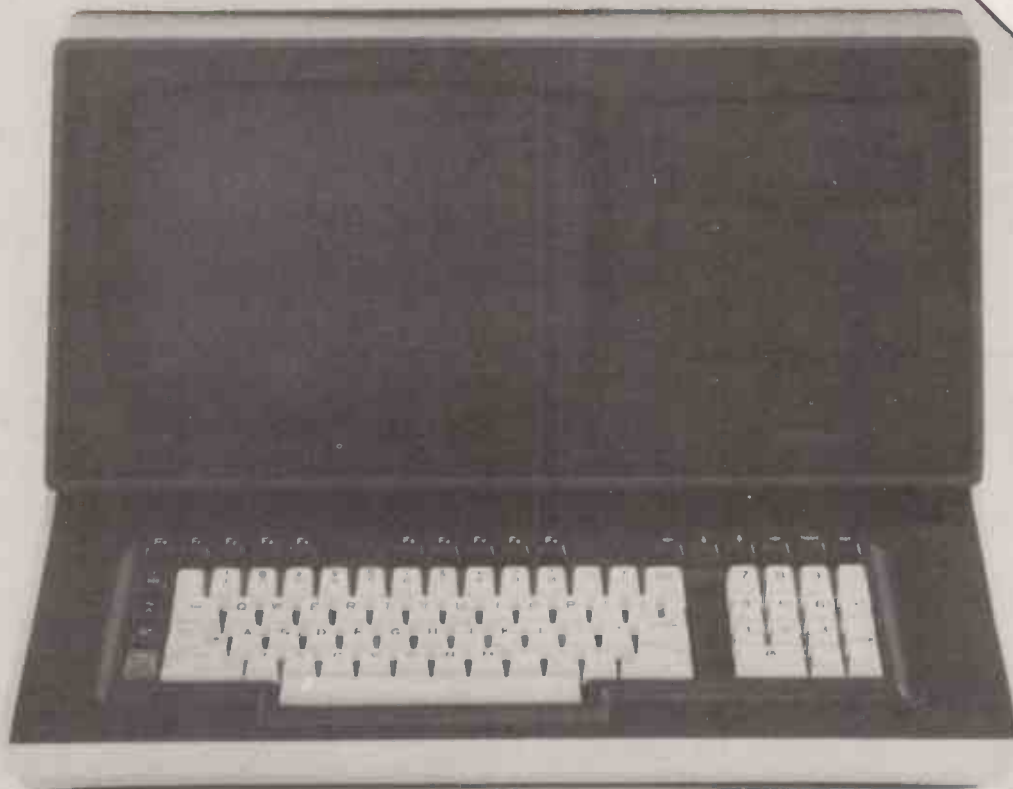

GIANTKILLER

System 10 is a new fully-integrated and highly flexible business computer which will provoke some major reappraisals of current standards of price, performance and value for money.

It is compact, reliable, portable and easy to use.

It compares favourably in price, specification and performance with a lot of well-known names and is very much more versatile.

GIANT KILLING PERFORMANCE!

For the technically minded, the main features of System 10 include:

- Z80 CPU 4MHz
- 65K RAM Standard
- 700K Mass Storage on Dual Minifloppys
- Hard Disk Interface — Additional Mass Storage
- Choice of Disk Operating Systems — CP/M — PASCAL
- 2 RS232 Serial Ports (ie Printer and Modem)
- 1 RS449 Serial Communication Port
- 1EEE 488 GPIB Parallel I/O (optional)
- High Speed Arithmetic Processor (optional)
- PROM Resident Disk Boot and Diagnostic Monitor
- Extensive Software Support Available
 - Fortran — Basic — Pascal — Cobol
- **£2995.00 (EXCL. VAT)**

INPUT OUTPUT PANEL

Flexibility and convenience is built in.



For those more interested in applications than technical jargon System 10 will do everything most small businesses need from a computer, including word processing, accounting, stock control and payroll, with readily available software. The Mainframe communication package makes System 10 an ideal smart terminal for Mainframe pre-processing and data entry.

System 10 — a brilliant new computer from Millbank.

Showroom & Offices:
98 Lower Richmond Road
London SW15
Telephone: 01-788 1083

**MILLBANK
COMPUTERS**

Service Department:
East Lane
Kingston upon Thames, Surrey
Telephone: 01-549 7262

• Circle No. 121

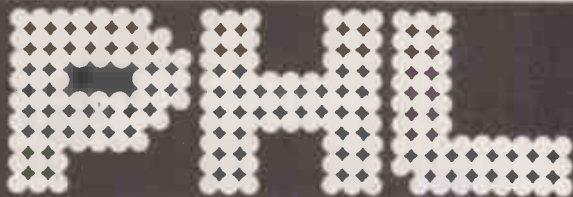

...when you need a dependable supplier, an authorised distributor with a comprehensive range of products at keen prices, backed by large stocks for fast delivery, with full after-sales support. We promise you a rapid response.

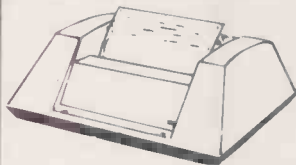

ANADEX DP8000

Exceptional value and high reliability. 84 lines per minute, 112 cps. Parallel and serial interfaces as standard. 96 ASCII set, 9 x 7 font. Variable tractor. Forms handling facilities. 1K buffer store. Options include 2K extra store IEEE interface.

from only **£494**



LEAR SIEGLER ADM-3A

The most popular visual display in the world. 1920 character screen capacity. Cursor addressing. Dual interface. Auxiliary port. Wide range of speed and word formats. Options include Tektronix 4010 compatible graphics.

from only **£545**

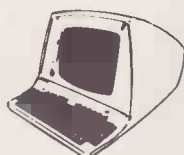

LEAR SIEGLER ADM-31

Low cost VDU with two page display and full editing features. Dual interface, 50-9600 baud data rates. Upper/lower case character set. Cursor addressing, editing, protected fields, dual intensity. Optional polling and addressing, printer port.

from only **£795**



LEAR SIEGLER ADM-42

Semi-intelligent VDU with up to 8 pages of display. Full editing features, blinking, blanking, cursor addressing, format transmission, protected fields, dual intensity, separate function keys, status display. Optional alternative character set, programmable function keys, synchronous interface, line drawing set.

from only **£1049**



TYPEWRITER TERMINAL

Two machines for the price of one. Typewriter style friction feed for single documents, letters etc. Pin feed for continuous business stationery. Electric typewriter keyboard layout and touch. Left and right hand margin setting. Crisp, high quality printout.

from only **£799**



**SPECIAL
£1275
OFFER**

TEXAS 810

Compact 150 cps 132 column printer. Optimised bi-directional printing. Adjustable tractor feeds, 3 - 15 inches. 9 x 7 dot matrix. RS232 interface. Forms control options. Other serial and parallel interface options. Compressed print option.

LOW COST GRAPHICS TERMINAL



£1295

A low cost Tektronix 4010 software compatible option means that we can offer the well-known Lear-Siegler ADM 3A with powerful graphics capability. A Z-80A microprocessor and RAM sufficient to provide a 512 x 250 dot grid and automatic scaling from a 1024 x 780 dot grid enable point plotting, vector drawing and alphanumeric character display. Call today for a demonstration or more details.

PERIPHERAL HARDWARE LIMITED

Armfield Close West Molesey Surrey Telex 922175

SOUTH
01-941 4806

NORTH
Harrogate 501263/4

IRELAND
Dublin 952316

Announcing ...

PicChip

A GRAPHICS MODULE FOR THE PET

The PicChip is a plug-in ROM module which adds over forty parameterised high-level BASIC commands enabling the graphic capabilities of the PET to be fully exploited. Complex shapes and patterns — moving or static — may be constructed concisely and clearly in simple BASIC programs. These fast commands pick up their parameters directly from BASIC variables X, Y, X0, Y0, X1, X2, Y1, Y2, A1, A2, N, C.

Besides such useful facilities as a repeat-key on/off command, the available functions include:

Character Density (40 x 25)

- * Define rectangular window area
- * Area fill with character C
- * Area roll or shift N up, down, left, right
- * Set area in upper/lower/inverted case
- * Set area normal/reversed/inverted
- * Cursor position read/set to X, Y
- * Poke character C to X, Y
- * Copy screen to/from any RAM address

Double Density (80 x 50)

- * Draw/erase point at X, Y
- * Draw/erase line from X1, Y1 to X2, Y2
- * Draw/erase perpendicular to X/Y axis
- * Draw/erase continuous line

Fine Density (40 x 200/25 x 320)

- * Plot X value with 320 resolution
- * Plot Y value with 200 resolution

Excellent for process-diagrams, maths, teaching-aids, games, moving graphs etc. Works with 'New ROMs' only. Plugs in to UD5 socket on 16/32K models. Earlier PETs need bus-adaptor.

PicChip complete with comprehensive handbook: **£57.50** inclusive

Handbook separately: **£5.00**

Sterling cheque with order to:

Houghton-Insel Computer

Arabellastrasse 58
8000 Muenchen 81
West Germany

UK Distributor enquiries invited.

• Circle No. 122

• Circle No. 123

'TUSCAN' FROM TRANSAM



Take a step up to your next Computer!

THE CONCEPT

How many ways are there to build an S100 system? Not many, and all expensive. TUSCAN changes all that.

Five S100 boards on one single board — just for starters. Plus five extra slots for future expansion.

What a combination! Z80 and S100 with the TRANSAM total package of system and applications software.

How do we do it? Our prices start at £195 and you can build up in easy stages to a fully CP/M compatible disc based system. Something to think about!

THE HARDWARE

The first Z80 single board computer with integral S100 expansion. British designed to the new IEEE (8 BIT) S100 specification, the TUSCAN offers total system flexibility. A flexibility available now.

The board holds the equivalent of a Z80 cpu card, 8k ram, 8k rom video and I/O cards with 5 spare S100 expansion slots and offers a price/performance ratio which is hard to beat.

Just compare our price with a commercial S100 ten slot motherboard with this specification.

THE SOFTWARE

TUSCAN offers the user the choice of system monitor, editor, resident 8k basic, resident Pascal compiler or full CP/M disk operating system. All options are upwards

compatible and fully supported with applications software. Both 5¼" and 8" drives are supported in double density.

THE PACKAGE

TUSCAN is available in kit form or assembled. With several hardware and software options to suit your requirements and budget. Attractive desk top case also available holds 2 x 5¼" Drives.

TRANSAM

NOBODY DOES IT BETTER!

Send to Transam Components Ltd., 59/61 Theobald's Road, London WC1.

I am interested in the TUSCAN Z80 based single board computer with S100 expansion and enclose a S.A.E. for further details.

Name _____

Address _____

Telephone _____

TRANSAM COMPONENTS LTD., 59/61 THEOBALD'S ROAD, LONDON WC1. TEL: 01-405 5240/2113

• Circle No. 124

Successful business?... Yes, with the Megamicro

average installed system
less than **£8000** plus VAT

complete with

Hardware including printer
Software including programs
Staff training
Installation & delivery
Support by manufacturer

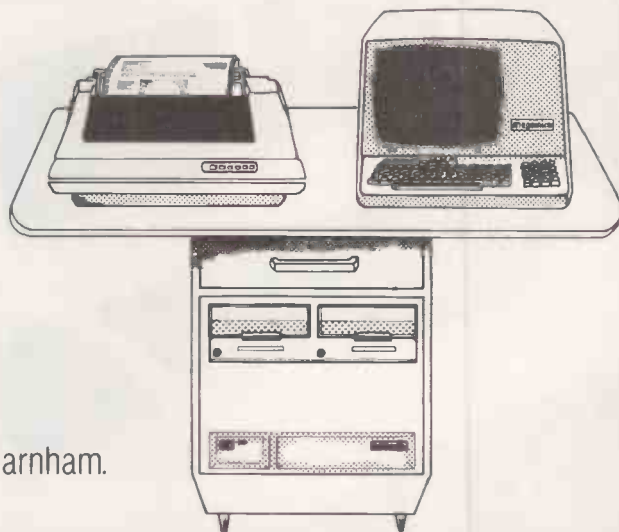

British built by:
Bytronix Microcomputers Ltd, 83, West Street, Farnham.
Telephone: (0252) 726814

• Circle No. 125

STCS

ST Commercial Systems Ltd

24 Ranelagh Road, London W5 5RJ
England

SuperBrain



COMPLETE twin Z80 CP/M computer system with 64K RAM twin double density disk drives, printer, 2 RS232 ports, integral VDU and BASIC or FORTRAN. Plus a full year's guarantee . . . **£2,800+VAT**

Printer

MICROLINE-80 by OKidata, the quietest, most reliable little printer available – 40, 80, or 132 characters per line with graphics.

Software

Microsoft BASIC or FORTRAN for no extra charge.

Guarantee

All hardware fully guaranteed for a year. If anything goes wrong we'll have an engineer on your premises within 24 hours – wherever you are in Britain.

SPECIAL Educational and quantity discounts – Dealer enquiries invited:

We also stock CP/M software:-

Wordstar, Selector, all Microsoft languages, CBASIC . . . and lots more.

AND . . .

TELEVIDEO terminals – call for prices. Very special dealer deals.

NEC Spinwriters – all models.

CALL Maria or Gerv: 01-840 1926 anytime 01-992 2909 after hours.

• Circle No. 126

HAL COMPUTERS

NEW FROM



A complete range of professional floppy disc products from the industry leaders....compatible with TRS 80, Superbrain, Ohio, SWTP, North Star Horizon, Zenith, Cromemco etc.

You can now buy the entire range of Tandon Magnetics high quality, market leading, mini flexible disc drives direct from the exclusive U.K. Distributor.

Tandon drives are available as either the OEM product or as complete packaged units in single or dual drive British manufactured cabinets with high reliability power supply. Complete pre-test and burn in ensures reliability and all drives carry a full 6 months parts and labour warranty.



BOXED DRIVE PRICES

| | Single Box | Dual Box |
|---|------------|----------|
| Single Sided 40 track | £250.00 | £430.00 |
| Double Sided 40 track | £330.00 | £599.00 |
| Double Sided 80 track | £430.00 | £808.00 |
| Dual Boxed Single Sided plus double sided | £549.00 | |

With Tandon you get 40 or 80 tracks—more capacity and step rates as low as 3 mS track to track—up to ten times the speed of other drives.



8" DRIVES AVAILABLE - CALL FOR PRICES.

CONTROLLERS



Try us for S-100, Apple, Rockwell, AIM 65, Nascom, Pet.

HIGHEST QUALITY DISKETTES



As disc capacity has increased, the cost of data stored on diskettes has quadrupled. We recommend only the highest quality discs for use with Tandon

drives and we sell the complete range of Dysan media for 5 1/4" and 8" as well as alignment diskettes. Send for brochure. All in boxes of 10.

* 40 track

| | |
|----------|--------|
| 8" SSSD | £34.20 |
| 8" DSDD | £48.60 |
| 5" SSSD | £26.00 |
| 5" DSDD* | £40.00 |

STORAGE SYSTEMS



Use our discoflex range of storage wallets and boxes to protect your discs when not in use, or for sending through the post.

| | |
|--------|--------|
| 5 1/4" | £10.00 |
| 8" | £12.00 |

POWER SUPPLIES



Our range of Power-One power supplies covers single, dual and triple output not to mention a complete selection of supplies which power all popular floppy disc drives.



SERVICE AND MAINTENANCE



For the large scale user of 5 1/4" or 8" floppy disc drives, our range of alignment diskettes and service tools are a must. Send for details of our Oasis range of

portable dedicated and non-dedicated floppy disc and peripheral test and exerciser systems.

For immediate information on any of these products please contact:

HAL COMPUTERS LIMITED

133 Woodham Lane New Haw
Weybridge Surrey KT15 3NJ
Tel: Weybridge (0932) 48346/7
Telex: 8813487

P.E.T, APPLE & ITT 2020 DEALERS & USERS

See the **NEW 8032 SUPERPET** with 80 column screen, **APPLE II & ITT 2020**, on demonstration with our powerful

CREAMWOOD BUSINESS CONTROLLER & MANAGER

Ledger Software packages offering the following features that every business needs:—

- Generates statements, Quotations, Invoices and mailing list.
 - Maintains up to 550 Accounts & 2400 transactions on each disk — can be extended without limit.
 - Instant comprehensive display of Account information at anytime.
 - Real time operation — no batch operations.
 - Comprehensive printout of Accounts and Journals.
 - Powerful Analysis features.
 - Easy to use and understand.
 - Written by professionals in conjunction with accountants.
 - From: £290 + VAT. (retail.)
- DEALERS:— Contact us for our very attractive dealer terms and demonstration package.
- USERS:— contact us for the name of your nearest dealer.

Our large modern software shop is open Tuesday - Saturday 10AM - 6PM.

CREAMWOOD SOFTWARE PRODUCTS LTD.

380, STATION ROAD, HARROW, MIDDX. HA1 2DE.

(3 MINS HARROW-ON-THE-HILL STN.)

MET LINE 01-863 0833

• Circle No. 128

REAL-TIME SPECTRUM ANALYZER £340

You can now buy, for about one-sixth the price of current products, a third-octave spectrum analyzer with more features and capabilities than were previously available at any price. What's the catch? If you don't already own a Commodore PET computer, a Radio Shack TRS-80 or Apple, you'll have to get one. This will raise the price to somewhat under one-half the price of competing products, but of course you'll also have a COMPUTER!

The THS 224 REAL-TIME FREQUENCY ANALYZER comprises a single circuit board which installs inside the PET. This board contains a set of 31 analog third-octave filters (20 Hz to 20 kHz), detectors, an analog-to-digital converter, a 1K Read Only Memory containing machine language routines which allows the PET processor to interface with the Analyzer, and the peripheral circuitry necessary to transfer analog data into the PET memory. The simplest BASIC program required to turn the PET into an analyzer is only three statements long! Much longer programs can be written to allow complete user interaction with the analyzer, including many new forms of statistical signal processing, curve weighting, voice recognition etc.

• COUNTLESS EDUCATIONAL APPLICATIONS



EXPANSION MEMORY

with space for eeprom

Price
break-
through

24k
£280



32k
£325

All items can
be seen and
demonstrated at
our London showroom.
Orders accepted by
mail, phone or in person.

**PETS 8k inc. cassette
from £380**

PET IS A TRADEMARK OF
COMMODORE BUSINESS SYSTEMS

Prices exclude VAT. Send or phone
for further details and brochure.

Access, Barclaycard,  
and Trustcard accepted.



UK Distributors

Feldon Audio Ltd.,

126 Great Portland Street, London W1 Tel 01-580 4314. Telex London 28668.

• Circle No. 129

WE HAVE ALL THE NEW ATARI®
VIDEO GAME PROGRAM™
CARTRIDGES.

ATARI £86 + VAT

SILICA SHOP

ELECTRONIC GAMES

ATARI

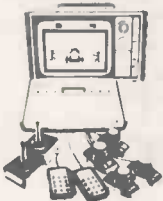

SPECIAL PRICE
£86 + VAT

SPACE INVADERS



HAND HELDS - CARTRIDGES
ATARI ACETRONIC
PRINZTRONIC
RADOFIN DATABASE etc.
We keep a full range!
Send for cartridge lists stating which machine you own.

INTELLIVISION MATTEL

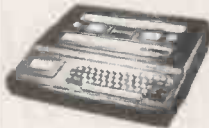

£173.87 + VAT

Available August 1980
This is the most advanced TV game in the world. Expandable next year into a full microcomputer. COLOUR CATALOGUE AVAILABLE WITH DETAILS ON ALL THE CARTRIDGES

BRIDGE

COMPUTER



- * Plays 1/2/3 or 4 Hands
- * Problem Mode
- * Audio Feedback
- * Instant Response
- * Auto scorekeeping

DRAUGHTS

COMPUTER



- * Solves Problems
- * Rejects illegal moves
- 2 level machine £43 + VAT
- 4 level machine £77.78 + VAT

CHESS COMPUTERS



Send for further details.

NEW RANGE AVAILABLE AUGUST 1980
We specialise in computer chess machines & stock over 13 different models from £20 to £300

BACKGAMMON

COMPUTERS

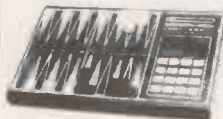

From £38 to £108. Send for further details.

OMAR 1
OMAR 2
CHALLENGER
GAMMONMASTER

LEISURE

- * CHEAP TV GAMES
- * TELEPHONE ANSWERING MACHINES
- * AUTO DIALERS
- * CALCULATORS
- * DIGITAL WATCHES
- * PRESTEL
- * HAND HELD GAMES

TELETEXT



RADOFIN
TELETEXT
Add on Adaptor
£199 + VAT

27 TUNE DOOR BELL

£17.13 + VAT



FREE CATALOGUE

For a free copy of our 32 page catalogue, send a 12p stamp to Silica Shop Ltd or Telephone 01-301 1111

MAIL ORDER SERVICE — Free postage & Packing

TELEPHONE & MAIL ORDERS - accepted on:
Access * Barclaycard * American Express * Diners Club

CALLERS WELCOME — at our shop in Welling — Demonstrations daily
Open from 9am-5pm Mon-Sat (9am-1pm Wed)

GUARANTEE — Full 12 months + After Sales Support

We have comprehensive brochures on all products. Please let us know what you are interested in and we will send you detailed brochures AND our own 32 page catalogue covering most games on the market.

SILICA SHOP

SILICA SHOP LTD., Dept. PC9
102 Bellegrave Road
Welling, Kent DA16 3QF
Tel: 01-301 1111

• Circle No. 130

TRS-80 OWNERS!

LEVEL II CASSETTE

MODEL I

| | |
|------------------------------|--------|
| Adventures:— | |
| Adventureland* | £8.50 |
| Pirates Cove* | £8.50 |
| Mission Impossible* | £8.50 |
| The Count* | £8.50 |
| Voodoo Castle* | £8.50 |
| Strange Odyssey* | £8.50 |
| Mystery Fun House* | £8.50 |
| Pyramid of Doom* | £8.50 |
| Ghost Town* | £8.50 |
| Adventure Sampler* | £5.50 |
| Air Raid* | £8.50 |
| Alien Invaders | £8.50 |
| Amaz'in Mazes | £5.00 |
| Android NIM | £8.50 |
| Backgammon | £5.00 |
| Balloon Race | £5.00 |
| Barricade* | £8.50 |
| Baseball | £5.00 |
| Battleship | £8.50 |
| Bee Wary | £8.50 |
| Bingo | £4.00 |
| Bowling (Ten Pin) | £5.00 |
| Breakaway | £4.00 |
| Bridge Challenger | £8.50 |
| Challenge | £6.00 |
| Concentration | £5.00 |
| Cribbage | £5.00 |
| Dogstar | £6.00 |
| Fastgammon | £10.00 |
| Galactic Blockade | £5.00 |
| Galactic Empire | £8.50 |
| Galactic Revolution | £8.50 |
| Galactic Trader | £8.50 |
| Game of Life* | £6.00 |
| Hangman | £4.00 |
| Hit The Box | £6.00 |
| I Ching | £5.00 |
| Kamikaze | £5.00 |
| Kreigspiel | £5.00 |
| Lost Dutchmans Gold | £6.00 |
| Mastermind II* | £5.00 |
| Mean Checkers* | £11.00 |
| Noughts & Crosses | £4.00 |
| Othello III | £4.00 |
| Pentominos | £8.00 |
| Pork Barrel | £8.00 |
| Pre School Games | £8.00 |
| PR Dogfight | £5.00 |
| Remainder | £5.00 |
| Robots | £4.00 |
| Round The Horn | £6.00 |
| Safari | £5.00 |
| Santa Paravia | £8.50 |
| Sargon II | £8.50 |
| Ship Air Battles | £8.50 |
| Salom | £8.50 |
| Snake Eggs | £8.50 |
| Space Battles | £8.50 |
| Star Trek III.4 | £8.50 |
| Taipane | £5.50 |
| Timebomb | £8.50 |
| Timetrek* | £8.50 |
| Treasure Hunt | £5.00 |
| Trek '80 | £8.50 |
| Trolls gold | £5.00 |
| Tycoon | £5.00 |
| Video Checkers | £8.50 |
| Warfare I | £5.00 |
| X-Wing Fighers II | £8.50 |
| APL-80* (Incl Book) | £8.50 |
| Accounts REC II | £13.50 |
| Appointment Log | £6.00 |
| Astronomy II | £7.50 |
| Basic IP* | £11.00 |
| Basic Toolkit* | £11.00 |
| Biorythms | £4.00 |
| Calendar Functions | £7.50 |
| Data Base II | £16.00 |
| Debug* | £5.00 |
| Electric Pencil* | £5.00 |
| Electronics Asst. | £8.50 |
| EMU 6502 | £8.50 |
| ESP Tester | £8.50 |
| File Handling | £6.00 |
| Finance I | £4.00 |
| Finance II | £6.00 |
| Forth (Incl. Primer) | £5.00 |
| Fourier Transforms | £5.00 |
| Graph Builder | £5.00 |
| G.S.F.* | £6.00 |
| General Accounting | £5.00 |
| Ham Radio | £11.00 |
| Histogram/Scattergram | £4.00 |
| Home Finance | £6.00 |
| Inst. Calculator | £8.50 |
| Inventory Mod. | £7.50 |
| Inventory PP. | £11.00 |
| Inventory Control | £13.00 |
| IQ Builder (Vocab) | £11.00 |
| IQ Builder (Spelling) | £7.50 |
| IQ Builder (Stories) | £6.00 |
| IQ Builder (Pre School) | £5.00 |
| IQ Builder (Numbers) | £5.00 |
| IRV* | £16.00 |
| Keyboard 80* | £5.00 |
| Level III Basic* | £5.00 |
| Linear Programming | £8.50 |
| Magic Paper Calculator | £8.50 |
| Math Drill | £8.50 |
| Math Library I | £6.00 |
| Math Library II | £4.00 |
| Math Library III | £8.50 |
| Microtext Editor | £4.50 |
| Minicrossword | £6.00 |
| Mortgage Calculator | £4.00 |
| Personal Finance | £5.00 |
| Pascal* (Incl. Manual) | £5.00 |
| Personal X-REF | £5.00 |
| Pilot 2.2* | £5.00 |
| Pre Flight | £17.50 |
| RPN Calculator | £13.50 |
| RPN Calculator | £6.00 |
| RSM 2 Monitor* | £7.50 |
| Statistics | £11.00 |
| S.T.A.D.* | £11.00 |
| Star Finder | £4.00 |
| Super Simon | £7.50 |
| Super T-legs* | £16.00 |
| Super Step* | £12.00 |
| System Copy* | £5.00 |
| T-Short* | £6.00 |
| T-Short+* | £15.00 |
| Tarot Cards | £4.00 |
| Teachers Assistant | £7.50 |
| Tiny Comp* | £7.50 |
| TRS-80 Opera | £7.50 |
| Typing Tutor | £35.00 |
| X-ref | £7.50 |
| 76 Basic Programs | £6.50 |
| Manual for Above Library 100 | £14.50 |
| | £8.50 |
| | £6.00 |
| | £6.00 |
| | £6.50 |
| | £7.50 |
| | £11.00 |
| | £13.00 |
| | £11.00 |
| | £7.50 |
| | £15.00 |

| | |
|--------|------------------------------|
| £6.00 | IQ Builder (Stories) |
| £5.00 | IQ Builder (Pre School) |
| £5.00 | IQ Builder (Numbers) |
| £16.00 | IRV* |
| £5.00 | Keyboard 80* |
| £5.00 | Level III Basic* |
| £8.50 | Linear Programming |
| £8.50 | Magic Paper Calculator |
| £8.50 | Math Drill |
| £6.00 | Math Library I |
| £4.00 | Math Library II |
| £8.50 | Math Library III |
| £4.50 | Microtext Editor |
| £6.00 | Minicrossword |
| £4.00 | Mortgage Calculator |
| £5.00 | Personal Finance |
| £5.00 | Pascal* (Incl. Manual) |
| £5.00 | Personal X-REF |
| £5.00 | Pilot 2.2* |
| £17.50 | Pre Flight |
| £13.50 | RPN Calculator |
| £6.00 | RPN Calculator |
| £7.50 | RSM 2 Monitor* |
| £11.00 | Statistics |
| £11.00 | S.T.A.D.* |
| £4.00 | Star Finder |
| £7.50 | Super Simon |
| £16.00 | Super T-legs* |
| £12.00 | Super Step* |
| £5.00 | System Copy* |
| £6.00 | T-Short* |
| £15.00 | T-Short+* |
| £4.00 | Tarot Cards |
| £7.50 | Teachers Assistant |
| £7.50 | Tiny Comp* |
| £7.50 | TRS-80 Opera |
| £35.00 | Typing Tutor |
| £7.50 | X-ref |
| £6.50 | 76 Basic Programs |
| £14.50 | Manual for Above Library 100 |
| £8.50 | |
| £6.00 | |
| £6.00 | |
| £6.50 | |
| £7.50 | |
| £11.00 | |
| £13.00 | |
| £11.00 | |
| £7.50 | |
| £15.00 | |

DISK

MODEL II

| | | | | |
|--------|--|---------|----------------------------------|---------|
| £13.50 | A.P.L. Incl. Book | £30.00 | CP/M 2.2 (Cybernetics) | £150.00 |
| £7.00 | Accounts Receivable II | £40.00 | CBasic-2 | £70.00 |
| £26.00 | Advanced Personal Finance | £13.50 | Inventory System (Graham Dorian) | £300.00 |
| £7.50 | Amateur Radio System | £8.50 | Pascal 2 Ver3.0 | £150.00 |
| £8.50 | Auto Disk Directory | £13.50 | Postmaster | £75.00 |
| £4.00 | Compress It | £25.00 | Supersort III | £70.00 |
| £8.50 | Data Base III | £20.50 | | |
| £8.50 | Dynamic Data Base | £20.50 | | |
| £18.50 | Electric Pencil* | £75.00 | | |
| £6.00 | Forth* (Incl. Primer) | £45.00 | | |
| £7.50 | General Ledger II | £40.00 | | |
| £5.00 | Inventory 2.2 | £30.00 | | |
| £6.00 | Inventory 2.3 | £40.00 | | |
| £26.00 | Inventory II | £16.00 | | |
| £8.50 | KVP Extender* | £50.00 | | |
| £9.00 | Level I in Level II* | £13.50 | | |
| £11.00 | Mailist IV | £40.00 | | |
| £8.50 | Newdos Plus* | £47.50 | | |
| £6.00 | Payroll | £249.00 | | |
| £14.50 | Print Spooler* | £16.50 | | |
| £11.00 | Roots | £12.50 | | |
| £14.50 | RSM 2D Monitor* | £15.00 | | |
| £7.50 | Simplify-It | £13.50 | | |
| £6.00 | SRIPSIT* | £65.00 | | |
| £11.00 | ST-80* Terminal | £40.00 | | |
| £11.00 | ST-80 III* Terminal | £80.00 | | |
| £8.50 | Text-80 Word Processor | £30.00 | | |
| £7.50 | | | | |
| £12.50 | Taranto & Associates Conversion of Osbourne & Associates Business Programmes | £90.00 | | |
| £6.00 | Accounts Payable | £40.00 | | |
| £6.00 | Cash Journal (for G/L) | £90.00 | | |
| £11.00 | Invoicing | £90.00 | | |
| £12.00 | Accounts Receivable | £90.00 | | |
| £20.00 | General Ledger | £90.00 | | |
| £7.00 | Complete Co-ordinated System with Manuals | £350.00 | | |
| £40.00 | | | | |

WORD PROCESSORS

| | | |
|--------|---------------------------|---------|
| £45.00 | Electric Pencil II (CP/M) | £175.00 |
| £40.00 | Electric Pencil II TRSDOS | £190.00 |
| £30.00 | Magic Wand (CP/M) | £200.00 |
| £40.00 | Wordstar (CP/M) | £240.00 |
| £50.00 | Wordstar/Mailmerge (CP/M) | £300.00 |

BUSINESS SYSTEMS

| | | |
|---------|--|---------|
| £47.50 | Osbourne & Associates Programmes in CBasic:— | |
| £150.00 | Accounts Rec & Payable | £150.00 |
| £150.00 | General Ledger | £150.00 |
| | Manuals Available Separately for most of the above Programmes. | |

CP/M USERS GROUP

| | | |
|-----|---------|-------------|
| £23 | Volumes | Each £20.00 |
|-----|---------|-------------|

ALL PRICES INCLUDE FIRST CLASS POST AND PACKING (UK ONLY). SEND 50p FOR FURTHER PROGRAMM DETAILS

*Denotes Machine Language TRS-80 Trademark of Tandy Corp. CP/M Trademark OD Digital Res. C-Basic Trademark of Complier Systems.

MICROCOMPUTER APPLICATIONS

11 RIVERSIDE COURT, CAVERSHAM, READING RG4 8AL, ENGLAND

TELEPHONE: (0734) 470425



INTELLIGENT ARTEFACTS LTD

DISCOUNT PETS

NOW... SUPERPETS!

(IMMEDIATE DELIVERY)

8032 S/PET £825

8000-DISK £825

ALSO... STANDARD PETS

8K £400, 16K £500, 32K £600

C2N £54, DISK £650, TOOLKIT £45

INEXPENSIVE PRINTERS

EPSON TX808 (WITH PET GRAPHICS) £350

BASE 2 M800 STM (FRICTION & TRACTOR)

£390

TI-9.9/4 HOME COMPUTER

WITH COLOUR TV £860

NORTH STAR HORIZON 11 £1400

TECHNICAL BACKUP FROM MAPCON ENGINEERS. PRICES ARE EXCLUDING VAT

INTELLIGENT ARTEFACTS LTD

Cambridge Road, Orwell, Royston, Herts.
Telephone: Arrington 689

INTELLIGENT ARTEFACTS LTD

DISCOUNT COMPUTER SPECIALISTS

PET 8K £425 16K £500 32K £600

DISK £650 CASSETTE £50 TOOLKIT £45

SUPERPET 8032 £825 DISK 8050 £825

TEXAS TI99/4 £860 INCLUDING 14"

SKANTIC CTV/MONITOR

BASE 2 800B PRINTER £390

INC 2K BUFFER, FRICTION + TRACTOR FEED

EPSON TX80B PRINTER £375

FULL PET GRAPHICS, IEEE, PARALLEL or RS232

NORTH STAR HORIZON 32K £1450

WITH 2 SERIAL + PARALLEL I/O, 4 MHz

Z-80 DOS + BASIC

SUPERBRAIN 32K RAM 320K DISK £1500

64K 320K DISK £1750 64K 788K DISK £2400

WITH INTEGRAL DISK DRIVE + VDU

CP/M 2.2, Z-80 4MHz

SEND OR CALL FOR DETAILS.
PRICES EXCLUDE VAT.

• Circle No. 131

CP/M SOFTWARE

from

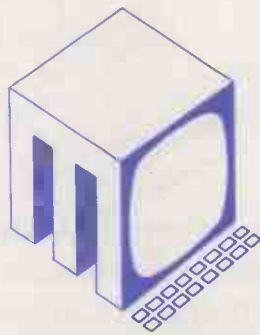

METROTECH

WORD PROCESSING

WORD STAR^{tm1} is the most complete integrated word processing system ever seen on a micro-computer. In less than six months more than four thousand people all round the world have purchased WORD-STAR. Version 2.0 is now available.

WORD-STAR 2.0 £255
WORD-STAR 2.0 with MAILMERGE £315

NEW * REPORT WRITER * NEW

Have you seen and liked VISICALC^{tm2}? Did you know that similar facilities are now available under CP/M^{tm3}?

REPORT WRITER will carry out your calculations and produce a columnised report with your headings, totals and summaries. Ideal for financial planning, budgeting and management reporting. Requires 48K, CP/M and Microsoft BASIC

REPORT WRITER £150

NEW * REPORT WRITER * NEW

LANGUAGES/UTILITIES

CBASIC II
Commercial Disk Extended Basic £75

SBASIC
Compiler Structured Basic £175

Microsoft BASIC-80
Interpreter Version 5 £155
Compiler £195

SUPERSORT I £125

WORD-MASTER Superior Text Editor £75

MET/UTIL advanced CP/M utilities to Backup & Initialise disks and Configure your machine environment £35

MET/TWAM — Index Sequential Files Access in CBASIC II £55

COMMUNICATIONS

BISYNC-80/3780 and **BISYNC-80/3270** are full function IBM 2780/3780 and 3270 emulators for microcomputers.

BISYNC-80/3780 gives you a Remote Job Entry terminal for the price of a micro!

BISYNC-80/3270 combines the local processing power of a micro with a sophisticated screen capability. Make your dumb terminal smart!

I/O Master — A superb S100 buffered I/O board which supports 3780 & Teletype communications, plus serial and parallel peripherals.

MET/TTY will connect your micro to a timesharing service in simple teletype emulation.

BISYNC-80/3789 £275
BISYNC-80/3270 £275
MET/TTY £95
I/O Master Board £225

DATA MANAGEMENT

SELECTOR III-C2
An easy to use Information Management System in CBASIC II £185

SELECTOR IV
An advanced Information Management System in SBASIC £275

DATASTAR
Powerful data entry, retrieval and update system £195

Micro Data Base System
MDBS is a full network database with many additional options.
Details and prices available on request.

All software is **ex-stock** and available on standard 8" disks or 5" disks for Cromemco Z2H, North Star Horizon, Vector MZ.

- Add 15% VAT
- Postage and Packing £1 per order
- State which disk type and size
- All orders prepaid
- Manuals available at £15 each

Telephone orders welcome with Access, Barclaycard, American Express or Diners Club
CALL 0895 57780 or Write to

METROTECH MAIL ORDER
WATERLOO ROAD
UXBRIDGE
MIDDLESEX UB8 2YW

tm1 WORD-STAR is a trademark of Micropro International Corp.
tm2 VISICALC is a trademark of Personal Software, Inc
tm3 CP/M is a trademark of Digital Research

enclosing cheque, PO's payable to METROTECH • Circle No. 132

computerkit

a new concept in
computer control

built on peripheral highway

apple and other interfaces
from £120

digital controller analog controller
from £150

relays from £10

digital sensors analog sensors
from £10

all you need for control application
in the laboratory, home, and industry

dealer enquiries welcome

BUSINESS COMPUTER SERVICES
POLLARDS FARMHOUSE, CLANVILLE
NR. ANDOVER, HAMPSHIRE
TELEPHONE 026470300

• Circle No. 133

micrologic

for Business Systems
based on the apple II
Microcomputer



Complete systems from
£2,500*. Agents for
Appleware. All
standard programs
available. Seminars arranged. Write
or 'phone for list of dates & venues.
Software to your own specification.

Visicalc
Performs many tasks:
Estimating; Costing;
Cash Flow Analysis
and many others on
your Apple.
No programming
knowledge
required. **£95***

Database
Allows you to create
your own filing system.
Search Routines,
Print Routines.
No Programming
knowledge
required. **£120***

* all prices ex. VAT

micrologic apple

Sales and Service
TEMPLE HOUSE, 43-48 NEW STREET, BIRMINGHAM

021-643 0253

• Circle No. 134

CHROMASONIC electronics

TELEPHONE 01-883 3705, 01-883 2289

your soundest connections in the world of components

56 FORTIS GREEN ROAD
MUSWELL HILL LONDON
N10 3HN

Phone or send
a S.A.E. for
latest price list
on all our range

PETS

All with new keyboard
and green screen

| | |
|---------------|------|
| 8N 8K RAM | £399 |
| 16N 16K RAM | £499 |
| 32N 32K RAM | £599 |
| CASSETTE DECK | £55 |

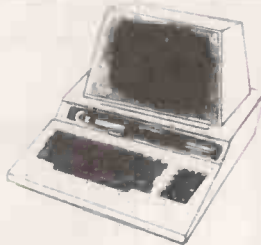

X-Y Plotters, Analogue to Digital Convertors, 16 Channel
Interfaces, B1 Directional Interfaces, etc.

LS Series

| | | | | | | | | | | | |
|--------|-----|--------|-----|---------|------|----------|------|----------|------|----------|------|
| 74LS00 | .18 | 74LS33 | .26 | 74LS83 | .60 | 74LS155 | .72 | 74LS192 | 1.04 | 74LS273 | 1.70 |
| 74LS01 | .18 | 74LS37 | .23 | 74LS85 | .81 | 74LS156 | .72 | 74LS193 | 1.04 | 74LS279 | .57 |
| 74LS02 | .18 | 74LS38 | .23 | 74LS96 | 1.16 | 74LS157 | .57 | *74LS194 | .86 | 74LS283 | 1.09 |
| 74LS03 | .19 | 74LS40 | .20 | 74LS107 | .32 | 74LS158 | .57 | 74LS195 | .97 | 74LS289 | 4.50 |
| 74LS04 | .20 | 74LS42 | .65 | 74LS109 | .32 | 74LS160 | 1.09 | 74LS196 | .97 | 74LS290 | .91 |
| 74LS05 | .22 | 74LS47 | .81 | 74LS112 | .32 | 74LS161 | .69 | 74LS197 | .97 | 74LS293 | .91 |
| 74LS08 | .20 | 74LS48 | .81 | 74LS113 | .32 | 74LS162 | 1.16 | 74LS221 | .92 | 74LS295 | 1.30 |
| 74LS09 | .22 | 74LS49 | .81 | 74LS114 | .32 | 74LS163 | .69 | 74LS240 | 2.08 | 74LS298 | 1.16 |
| 74LS10 | .20 | 74LS51 | .18 | 74LS122 | .69 | 74LS164 | 1.06 | 74LS241 | 2.08 | *74LS348 | 1.39 |
| 74LS11 | .20 | 74LS54 | .18 | 74LS123 | .72 | 74LS165 | .72 | 74LS242 | 2.08 | 74LS352 | 1.04 |
| 74LS12 | .20 | 74LS55 | .18 | 74LS124 | 1.39 | *74LS166 | 1.65 | 74LS243 | 2.08 | 74LS353 | .92 |
| 74LS13 | .37 | 74LS73 | .33 | 74LS125 | .36 | 74LS168 | 1.71 | 74LS245 | 2.50 | *74LS362 | 4.21 |
| 74LS14 | .65 | 74LS74 | .30 | 74LS126 | .36 | 74LS169 | 1.71 | 74LS247 | 1.09 | 74LS365 | .55 |
| 74LS15 | .20 | 74LS75 | .40 | 74LS132 | .60 | 74LS170 | 1.72 | 74LS248 | 1.09 | 74LS366 | .55 |
| 74LS20 | .20 | 74LS76 | .27 | 74LS133 | .39 | 74LS173 | .81 | 74LS249 | 1.09 | 74LS367 | .55 |
| 74LS21 | .20 | 74LS78 | .27 | 74LS136 | .36 | 74LS174 | .97 | 74LS251 | .96 | 74LS368 | .55 |
| 74LS22 | .20 | 74LS78 | .78 | 74LS138 | .65 | 74LS175 | .97 | 74LS253 | .92 | *74LS373 | .78 |
| 74LS26 | .20 | 74LS85 | .81 | 74LS139 | .65 | 74LS181 | 2.77 | 74LS257 | .92 | 74LS386 | .36 |
| 74LS27 | .20 | 74LS86 | .27 | 74LS145 | .97 | *74LS188 | 2.75 | 74LS258 | .92 | *74LS393 | .84 |
| 74LS28 | .22 | 74LS90 | .57 | 74LS151 | .81 | 74LS189 | 2.08 | 74LS259 | 1.39 | *74LS668 | 1.17 |
| 74LS30 | .20 | 74LS91 | .97 | 74LS153 | .52 | 74LS190 | .86 | 74LS261 | 4.50 | 74LS670 | 1.71 |
| 74LS32 | .26 | 74LS92 | .69 | 74LS154 | 1.30 | 74LS191 | .86 | 74LS266 | .87 | | |

UK 101

THE FASTEST GROWING
FOLLOWING KIT £179
OF THEM ALL

- Free sampler tape.
- 8K Basic in ROM
- 4K RAM expandable
to 8K on board.
- Kansas City tape
interface.
- RS232 Interface.
- Full QWERTY
keyboard.

NEW MONITOR CHIP
ALLOWS FULL
CURSOR CONTROL
AND EDITING £22

BUILT & TESTED
£229



PRINTERS



EPSON TX-80
£375

Dot-matrix printer with Pet
graphics Interface: Centronics
parallel, options: PET, Apple and
serial.



Phone or send s.a.e. for latest price list on all our range.
Please add VAT 15% to all prices. Postage on computers, printers, and cassette decks charged at cost, all other items P.&P. 30p.
Place your order using your Barclay or Access Card. (Minimum Telephone order £5.00). Trade and Export enquiries welcome.
Credit Facilities arranged.



• Circle No. 135

Introducing HP-41C

A powerful new calculator - with its own peripherals!

A new Hewlett-Packard calculator is always a special event. But the new HP-41C is especially special!

It's a fully programmable calculator - advanced, powerful and very versatile. Yet it's also remarkably easy to use, with a helpful alphanumeric display and a range of application modules.

Most important, it has its own dedicated peripherals - including printer, card reader and memory modules.

A unique machine

Program power. 400 lines of program memory (or 63 data storage registers) as standard, expandable up to 2000 lines (319 data storage registers). With RPN logic, for faster problem-solving.

Alphanumeric display. You can name and label programs, functions, variables and constants. The calculator uses words and sentences to prompt for data. The display shows calculator modes and status.

'Customise' feature. Assign any of 68 keyboard functions (or 130 library functions) - or any program you've written yourself - to any key on the HP-41C. To help you, the HP-41C comes with keyboard overlays. (Each assigned function or program name is displayed prior to execution.) Continuous Memory. Maintains program and data when your HP-41C is switched off. Simply switch on, and continue with your calculation.

A unique system

Look at this impressive list of add-on peripherals!

HP-41C printer. Quietly gives numeric, upper and lower case alpha characters, in single and double width, as well as special characters. And performs high resolution plotting routines. Application modules. For engineers, students, businessmen, scientists and others. Instantly converts your calculator to a specialised discipline.



HP-41C card reader. Saves program and data on magnetic cards. Keeps track of cards as they're read, and prompts you for the next card. Memory modules. Each contains 64 data storage registers (400 program lines, or any combination).

Incredible value at £192.55 (including VAT)!

This price includes the calculator, 63 registers for data or programs, owner's handbooks, overlay kit, zip-up pouch and batteries! Compare the HP-41C with other calculators in its price range. You'll find it has more functions and more options. See your dealer for a demonstration - you'll find his name below.

 **HEWLETT
PACKARD**



Aberdeen Tysell Typewriter Services. Belfast Cordiac Services Company. Birmingham Anglo American Computing. John Mabon Associates; Taylor Wilson. Bolton T & R Office Equipment. Bournemouth South Coast Business Machines. Brighton Office Machinery Engineering Co. Bristol Decimal Business Machines; Wilding Office Equipment. Bromley Wilding Office Equipment. Cambridge W. Heffer & Sons. Canterbury R. E. Typewriters. Cardiff Sigma Systems (Calculators). Carlisle Thos. Hill Group. Chelmsford Automatic & Electronic Calculators. Colchester Wilding Office Equipment. Croydon Landau Calculators; Wilding Office Equipment. Derby Office Machines. Dundee Toyside Office Equipment. Edinburgh Business & Electronic Machines; Holdene. Folkestone R. E. Hording. Glasgow Robox. Gloucester Wilding Office Equipment. Grimsby Teesdale Office Equipment. High Wycombe A. C. Barratt & Co. Ilford Wilding Office Equipment. Ipswich Anglia Business Machines; Wilding Office Equipment. Kingston-upon-Thames Wilding Office Equipment. Leeds Holdene; T & R Equipment. Leicester A. C. Barratt & Co.; Sumlock Services. Liverpool Rockliff Brothers. London Automated & Electronic Calculators; City Business Machines, 57 Houndsditch, Bethnal Green Road; Concept Business Machines; Dixons Photographic, 64 New Bond Street; Euro-Calc Limited, 128-132 Curtain Road, 224 Tottenham Court Road, 55 High Holborn; Landau Calculators, Bourne's, Oxford Street, 227 Tottenham Court Road; Logic Box; McDonald Stores; Melyclean, 137 The Strand, 92 Victoria Street; Mountindene; Reid's Office Equipment; Sumlock-Bondain, 15 Clerkenwell Close, Cannon Street Station; Wallace Heaton; Wilding Office Equipment, 7 The Arcade Hoe Street, 21 Thomas Street, 120 The Broadway, Wimbledon. Luton Wilding Office Equipment. Maidstone Wilding Office Equipment. Manchester Automated Business Equipment; Holdene; T & R Office Equipment. Matlock Derby Office Machines. Middlesbrough Thos. Hill Group. Newcastle Thos. Hill Group. Northampton A. C. Barratt & Co. Norwich Leamons Office Machines; Sumlock-Bondain. Nottingham Bennett's (Typewriter & Office Supplies); Trent Office Equipment. Oxford Reid's Office Equipment; Science Studio. Plymouth JAD Integrated Services. Reading Central Southern Calculators; Reid's Office Equipment, Coversham, 38 Market Place, Reading. Romford Wilding Office Equipment. Royston, Herts. Electroplan. Sheffield Butlers Office Equipment. Slough Wilding Office Equipment. Southampton South Coast Business Machines. Southend Wilding Office Equipment. Sunderland Thos. Hill Group. Sutton Landau Calculators. Swindon Wilding Office Equipment. Waltham Cross Wilding Office Equipment. Watford Automatic & Electronic Calculators; Wilding Office Equipment. Worthing Office Machinery Engineering Co. All UK branches of Comet. CHANNEL ISLANDS: Guernsey P.B.S. Jersey Professional Business Systems. EIRE: Dublin Abacus Systems.

• Circle No. 136

ENTER THE COMPUTER AGE

video genie system

**12K MICROSOFT BASIC
16K RAM, UHF MODULATOR
INTERNAL CASSETTE
SECOND CASSETTE
INTERFACE**

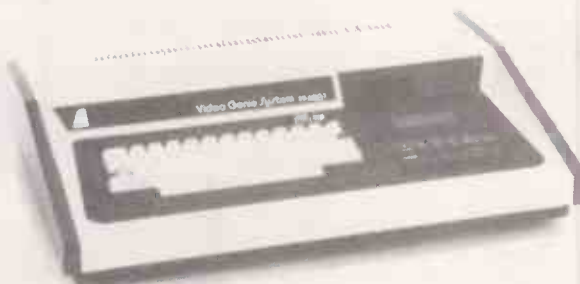

**£330
+ VAT**

**£395
+ VAT**

**80 COLUMNS
70 LINES PER MINUTE
GRAPHICS CHARACTERS
INTERFACES TO
MOST MACHINES**

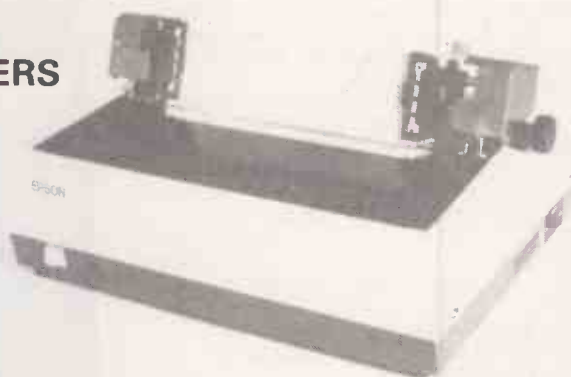

**100's OF PROGRAMS AVAILABLE
TRS-80 LEVEL II SOFTWARE
COMPATIBLE**

3 Line Computing
Advance TV Services
Allen TV Services
Amateur Radio Shop
Arden Data Processing
Blandford Computers
Briers Bookshop
Buss Stop

Hull 445496
Shipley 585333
Stoke on Trent 616929
Huddersfield 20774
Peterboro' 49577
Blandford 53737
Middlesbrough 242017
Watford 40698
Newport Pagnell 610625
Cambridge 314666

Cambridge Micro-
computers
Catronics
Cavern Electronics
Computer Business
Systems

Wallington 01-669 6700/1
Milton Keynes 314925
Lytham 730033

Computer and Chips
Computerama
Computopia
D B Microcomputers
Derwent Radio
Eiron Computers
Eley Electronics
G B Organs & TV
Gemsoft
Kansas City Systems
Kays Electronics
Leisurronics
Marton Microcomputer
Services

St Andrews 72569
Bath 333232
Leighton Buzzard 376600
Limerick 42733
Scarborough 65996
Dublin 808575/805045
Leicester 871522
St Saviour Jersey 26788
Woking 22881
Chesterfield 850357
Chesterfield 31696
Blackpool 27091
Northampton 890661
Melton Mowbray B12888
Stoke on Trent 541743

Matrix Computer Systems Beckenham 01-658 7508/
7551
Nottingham 298281
Liverpool 227-2535
Basingstoke 56417
Burnley 32209/53629
Cardiff 616936/7
Rayleigh 774089
Stevenage 65385
Garboldisham 316
Gravesend 55813
Bangor 52042
Nottingham 45466
Birmingham 554-0708
Watford 38923

LOWE ELECTRONICS

Low Electronics Limited, Bentley Bridge, Chesterfield Road, Matlock, Derbyshire.
DE4 5LE. Telephone 0629 2817 or 2430. Telex 377482 LOWLEC G
TRADE ENQUIRIES WELCOME

• Circle No. 137



**CRYSTAL ELECTRONICS
CC ELECTRONICS**

XTAL Basic 2-2 NOW ON SHARP MZ80K

All of the features of SHARP BASIC and more. Occupies 5K less memory, thus effectively increasing memory size for programs.

MZ80K 20K RAM £520+VAT
(with XTAL BASIC leaves 11K for programs)

XTAL BASIC for SHARP £40+VAT

Coming Soon—PETSOF* programs in XTAL BASIC format for SHARP & NASCOM—
Prices as PETSOF list+20%.

NASCOM 1 & 2 owners—XTAL BASIC 2.2 £35+VAT

NEW EPROM version £100+VAT

(please state monitor used)

EPROM version runs in E000H-FFFFH.

APPLE II PLUS OWNERS

APPLE INTEGER BASIC on disc for 32K or 48K APPLE.

Now you can run nearly all of your programs—
£20+VAT

* PETSOF is a trademark of ACT PETSOF LTD.

Members of Computer Retailers Association & Apple Dealers Association

Shop open 0930-1730 except Wed. & Sun.

40 Magdalene Road, Torquay, Devon, England. Tel: 0803 22699

Access and Barclaycard welcome.



• Circle No. 138

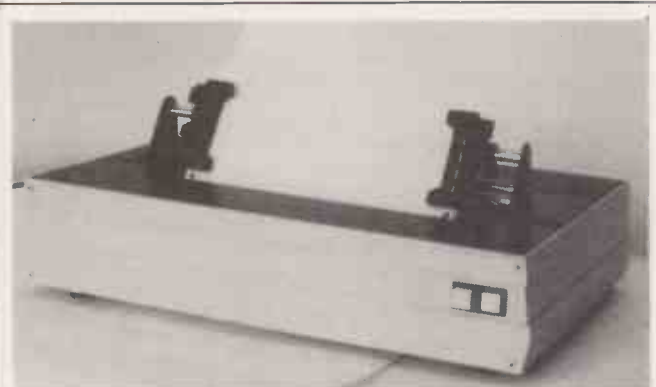

Z-800 MATRIX PRINTER

This low cost and compact printer has the following features as standard:

RS232, 20mA loop, Centronics parallel, IEEE488 I/O
72, 80, 96, 120, or 132 characters per line

User defined character set — software selectable

Tractor feed 9 1/2" wide paper. Pressure feed 8 1/2" wide paper

16 input data rates from 75 to 19200 bauds

2K terminal buffer Fast paper feed Self test switch

Price £360 + £5 carriage + VAT

Send stamped addressed envelope for details of this new printer, our range of programs and programming aids to:

ZERO ONE ELECTRONICS

36 Oaklands Avenue,

Thornton Heath, Surrey

CR4 7PH Tel: 01-689 7924



We repair the printers supply ribbons and paper

• Circle No. 139

Z89.



Altogether a better computer.

All the power and built-in peripherals for business and educational computing in one compact, desk top unit.

The Z89 Series Microcomputer.

Designed and built to the highest specification, the Z89 combines reliability and efficiency with ease of operation. And is backed, of course, by our excellent after sales service.

Features include:

- Z80 CPU
- Built-in floppy Disc with optional dual external drives
- Built-in Z19 VDU
- Up to 65K RAM
- Three serial RS-232 I/O
- Operating systems C/PM & H.DOS.

● Languages: M-Basic, C-Basic, Fortran, Pascal, etc.
And with generous OEM discounts available you can

see why the Z89 is a better computer.

Zenith data systems



For full details about the Z89, complete this coupon and return it to:

Zenith Data Systems Division, Heath Electronics (UK) Ltd.,
Dept. (PC10), Bristol Road, Gloucester. GL2 6EE.

Name _____

Company _____

Address _____

Z89

• Circle No. 140

Computing on a small budget...

You may have a limited budget, but that's no reason for your computer to be limited in its facilities! Mutek offer something better: Ohio Scientific's *Challenger* ranges — small systems for *real* computing, with real flexibility, expandability, reliability.

The superior Superboard...

The well-known Superboard, and the cased variant, the C1, stand out from the crowd of small single-board computers. Standard features include: a fast full-feature Microsoft BASIC; 4K of RAM in which to run programs; a compact machine-code monitor; a built-in 53-key keyboard; a video display of 25 lines of 25 characters for a standard TV, with a complete set of 256 alphabetic, numeric and graphics characters; and a superbly reliable cassette interface for loading and storing programs on a domestic cassette recorder. Both Superboard and C1 are ready-built and easily expandable to suit your needs and budget.

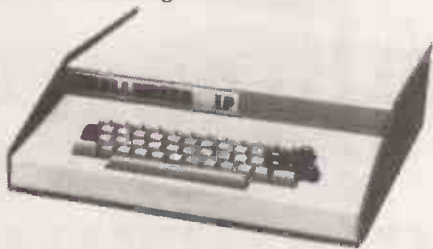

Mutek now offer their 'superior Superboard': an enhanced version, fully converted to UK standards, now running at double the standard speed, and with a more than doubled screen display of 32 lines of 48 characters each. That's more displayable characters than any other personal computer*, and a running speed for BASIC programs that's proven to be more than twice as fast as Pet® or Apple®, and nearly three times faster than the TRS-80®.

*...with the sole exception of Ohio Scientific's *Challenger 2* and *Challenger 4* ranges, with 32 lines of 64 characters — also available from Mutek.

The superior Superboard — a superbly practical small computer.

Enhanced C1 (C1E) £255

Complete with power supply, metal case and 4K of user memory.

Superboard E £195

Uncased version of C1E.

Standard C1 and Superboard available at £35 less than above prices.

Additional 4K RAM for on-board expansion £25

Upgrade service or kit to convert existing Superboard, C1 or UK101 systems to Mutek's enhanced specification (ask for details) £40

the versatile Challenger 4...

Mutek also offer Ohio Scientific's *Challenger 4* series, giving even more flexibility and versatility at a very reasonable price. The superb features of the C1 series are extended by a 32X64 colour display, tone generator, digital-to-analogue output, AC remote control, joystick and printer interfaces and much more. The C4 range uses the same 'bus' structure as OSI's large computers, giving access to the full range of OSI large-system boards — floppy and hard-disc drivers, high speed parallel/serial/D-A interfaces, PROM blaster, 'breadboard' prototyping board, and more than thirty others.

C4P 8K RAM, 16-colour 32X64 display £425

C4P-MF mini-floppy disc system £895

24K RAM, mini-floppy, RS-232 and parallel ports, real-time clock, foreground-and-background operating system

All prices quoted exclude VAT.

Mutek — practical computing...for less than you expect

Mutek — the independent Ohio Scientific specialists — Quarry Hill, Box, Wilts. Tel: Bath (0225) 743289

a superior monitor...

CEGMON, 'the best thing for OSI systems since OSI itself', is now available! CEGMON is a new monitor PROM for all Ohio Scientific BASIC-in-ROM systems (Superboard/C1, C2 and C4 series) and UK101, written by the organisers of the OSI UK User Group. It gives OSI systems the kind of features that only appear on machines at least twice the price — a full screen editor, an incredibly versatile screen-handling system, a built-in expanded machine-code monitor, and much more.

□ Full screen editing

Not just backspacing the cursor! — and more than a limited line editor which can only work on one line at a time. CEGMON's twin-cursor screen editor allows you to edit, combine, copy or renumber program lines or text, copying information from anywhere on the screen.

□ Advanced display features

All output to the screen display can be directed through 'windows' whose position, height and width are all user-definable, and can be changed within programs quickly and easily. The 'window' format allows free mixing of text and graphics; protected non-scrolling areas; and sophisticated use of multiple scrolling and non-scrolling zones. All this is supported by 'window'- and screen-clear routines and full cursor-positioning controls; text is printed from the top of the current 'window'. Probably the most flexible screen-handling system available today, it offers a whole new world in small-computer display.

□ Machine-code support

Particularly for those who haven't yet discovered the delights of machine-code programming, CEGMON's machine-code features will open another new world for you. The practical 'memory modify' routine now allows direct entry of text or graphics into memory as well as hexadecimal instructions. There's a tabular hexadecimal display of memory contents; a complete breakpoint handler for debugging machine-code programs; and of course full machine-code load and save routines.

□ and more!

Revised keyboard routine, for word-processing use; user-definable input and output, for printers and other additional equipment; most monitor routines can be used within your own programs — and CEGMON is of course completely compatible with OSI disc systems for C1/Superboard, C1E and UK101.

All this packed into a single replacement PROM! Versions available for standard Superboard/C1; Mutek's enhanced Superboard/C1; Challenger 2 or Challenger 4 (cassette systems only); and UK101. Further details available on request: please specify version required when ordering.

Price: £29.50 includes full documentation and reference card.

coming shortly...

A new expansion board designed in the UK for all OSI compatible systems. 12K RAM, space for 4K PROM, high-speed A-D/D-A input/output, high-speed cassette interface, VIAs and more. First deliveries October — ask for details.

We would be delighted to give you further information on our products and services — but please contact us *direct!*

AERCO GEMSOFT

Computer Services

Appointed dealers for

APPLE, SUPERBRAIN, VIDEO-GENIE

As well as supplying the Micro Systems above, we specialise in writing Software for those special applications that you cannot buy a package for: Special Stock controls, Invoicing systems, Production control and planning, Engineering, etc. (Our current projects include systems for Hire-Purchase accounts control, Stock Control for Hi-Fi retailers, Re-order scheduling, and a data-logging system.)

So, whether you require a Micro-Computer at a competitive price and supported with some intelligent advice, or a system with standard or special software, contact:

Aerco-Gemsoft Computer Services,
27, Chobham Road,
Woking,
Surrey GU21 1JD.
Telephone: Woking (04862) 22881

• Circle No. 142

Explorer/85

**8085 BASED
COMPUTER SYSTEM
WITH S100 ON BOARD
WE DO IT BETTER!**



| | EX VAT KIT | W/T |
|---|---------------|--------|
| MOTHER BOARD (A:B:D) 2K monitor ROM: 4K Users RAM: Will connect direct to Video Terminal: 2 S100 Pads: RS232 & 20ma loop: cassette interface: Full buffering for S100 Cars: fully regulated: etc. | 176.00 | 211.00 |
| VIDEO KEYBOARD TERMINAL: 1K Video RAM cpu controlled, 128 characters: ASC11 or Boudot terminal I/O: RS232 or 20ma loop: Upper & Lower case: full cursor control 32/64 characters 16 lines (does not include monitor) | 114.00 | 139.00 |
| MICROSOFT BASIC: 80 in ROM (plus E) | — | 69.00 |
| STEEL CABINET FOR Mother Board (IBM Blue/Black) | — | 36.00 |
| STEEL CABINET FOR KEYBOARD TERMINAL (IBM/ Blue/Black) | — | 15.00 |
| S100 EXPANSION CAGE (C) allows total of 6 S100 cards P.S.U. | 28.00 | 36.00 |
| 16K 'JAWS' DYNAMIC RAM CARD (cpu controlled) expandable to 64K runs 8085: Z80: 8080 etc based systems | 149.00 | 169.00 |
| 16K Expansion Kits | 69.00 | — |
| S100 Connectors | — | 5.50 |
| RF Modulator (for TV use as monitor) | — | 2.75 |
| Intel 8085 Users manual | — | 5.00 |
| Monitor Source Listing | — | 5.00 |
| COMING SHORTLY:— FULL FLOPPY DISC SYSTEM MONITORS 9" & 12" | | P.O.A. |
| ELF11 RCA COSMAC 1802 Based System, Basic board | 59.95 | 79.95 |

Newtronics

255 ARCHWAY ROAD, LONDON N. 6

TEL: 01-348 3325

• Circle No. 143

Z19.



The Intelligent terminal.

The Z19 'intelligent' Video Terminal, from Zenith Data Systems, is ideal for a wide variety of high-speed data handling tasks.

Compatible for use with EIA RS-232 or 20mA current loop, it has all the capabilities and features you'd expect from a top-of-the-line peripheral.

- Z80 Microprocessor based electronics
- Special deflection system for sharp resolution
- Full editing functions, plus user-definable keys
- Reverse video by character
- 24 lines of 80 characters plus 25th user status line
- 5 x 7 Dot matrix (upper case)
- 5 x 9 Dot matrix (lower case)
- 128 characters (95 ASC11 and 33 Graphic)
- ANSII and DEC VT 52 compatible

And there's one feature of the Z19 you wouldn't expect. The price. Just £735, exclusive of VAT and delivery charges.

Generous OEM discounts are available.

**Zenith
data
systems**



For full details about the Z19, complete this coupon and return it to:

Zenith Data Systems Division, Heath Electronics (UK) Ltd.,
Dept. (PC10), Bristol Road, Gloucester, GL2 6EE.

Name _____

Company _____

Address _____

Z19

• Circle No. 144

WE HAVE MOVED

FROM



TO



OUR NEW ACCOMMODATION IS IDEALLY SUITED FOR YOU TO SEE

THE LATEST DESKTOP
MICROCOMPUTER
HP 85

AND

THE LATEST POCKET COMPUTER
SHARP PC1211
COMPLETE WITH CASSETTE I/F



PRICE FROM £1830 + VAT



PRICE £117 inc. VAT & CARRIAGE COMPLETE

DEMONSTRATIONS BY APPOINTMENT AND ORDERS TAKEN BY PHONE.
GOVERNMENT, EDUCATION AND COMPANY ORDERS ACCEPTED FOR THE ABOVE
AND MOST MAKES OF CALCULATORS AND MICROCOMPUTER SYSTEMS.
ACCESS AND BARCLAYCARD HOLDERS WELCOME.

SUMLOCK BONDAIN LTD

NEW ADDRESS:
263/269 CITY ROAD,
LONDON EC1V 1JX.
(700 Yards from Angel Underground)
PHONE: 01-250 0505
OR
TELEX: 299844

• Circle No. 145

Master Your Micro FAST with...

Little Genius floppy diskette based courses will teach you, how to use your system and how to realise the full potential of the "Mighty Micro". These fully interactive computer lessons will guide you quickly to a high level of understanding and confidence in your ability to make the most of your microcomputer system.

Courses now available:

- Applesoft BASIC
- Advanced Applesoft BASIC
- Using your Apple
- Palsoft BASIC
- Advanced Palsoft BASIC
- Using your 2020
- PET BASIC
- Advanced PET BASIC



Little Genius

Each course, comprising a floppy diskette, and starting instructions, costs only £40.00 plus VAT.

SPECIAL "3 in one" OFFER for 3 courses covering the same system only £99.00 plus VAT.

Little Genius courses are available from most computer retail outlets, or direct mail order from:

LITTLE GENIUS

Suite 504, Albany House, 324 Regent Street, London W1R 5AA.
Telephone: 01-580 6361

• Circle No. 146

Happy Memories

MEMOREX MINI-FLOPPY DISCS
IN PLASTIC LIBRARY CASES

Soft sectored for PET, TRS-80 etc:

£19.95 per 100 including VAT and Postage.

16K Memory Upgrade Kits for TRS-80, APPLE,
2020, SORCEROR £35 inclusive
(Stage your application)

RS-232 Plugs and Sockets

Male: £1.95 Female: £2.25 Hoods 75p

All prices include VAT. 30p postage on orders
under £10. Government and Educational
orders welcome.



**HAPPY MEMORIES
GLADESTRY
KINGTON
HEREFORDSHIRE
HR5 3NY
TEL: (054 422) 618**



• Circle No. 147

WH14.

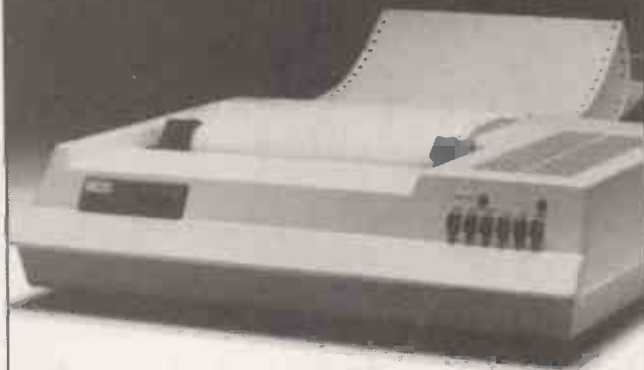

First in line.

If you're looking for an above average line printer at a lower than average price then the WH14 from Zenith Data Systems is your first choice.

Microprocessor controlled, this compact table-top unit can be used with most computers through a standard serial interface. It provides hard-copy output of your programmes as you execute them, plus handy copies of address lines, lists and other programming data for educational or business applications.

Features include:

- 5 x 7 Dot matrix printing
- Clear easy-to-read images
- Upper and lower case characters
- Operator/software selectable line width: 132, 96 and 80 characters per line.
- Sprocket paper feed with adjustable spacing
- Stepper motor feeds allows 6 or 8 lines per inch vertical.
- Form feed operator/computer control
- Microprocessor based electronics

And at £510, exclusive of VAT and delivery charges, the WH14 puts economy first in line too.

Generous OEM discounts are available.

**Zenith
data
systems**



For full details of the WH14, complete this coupon and return it to:

Zenith Data Systems Division, Heath Electronics (UK) Ltd.,
Dept. (), Bristol Road, Gloucester, GL2 6EE.

Name _____

Company _____

Address _____

WH14

• Circle No. 148

**the
software
house**

**146 Oxford St.
London W1.**

**Our NEW Catalogue
is now available !**

100'S of superb programs !

PLEASE RUSH ME A COPY.....

**I enclose £1 (deductible from 1st
order) for your descriptive and
illustrated catalogue**

Name

Address

• Circle No. 149

**PET PRICES DOWN!
AT THE ...**

**BUSS
STOP**

| PET | | KIM | |
|---------------------|---------|----------------------|--------|
| 8K RAM | £379.00 | KIM1 | £93.00 |
| 16K RAM | £495.00 | KIM 3B | £96.95 |
| 32K RAM | £625.00 | KIM 4 | £65.00 |
| DUAL DISK DRIV | £625.00 | PET-IEEE LEAD | £18.75 |
| PRINTER FRIC | £337.00 | IEEE-IEEE LEAD | £23.44 |
| PRINTER TRAC | £383.00 | PETSOFT TOOL KIT FOR | |
| EXT CASSETTE | £49.50 | 16K/32K | £55.00 |
| PET PASCAL COMPILER | | 8K | £75.00 |

NOW AVAILABLE

NEW SUPER PETS

8032 £895.00

8050 £895.00

NOW ON DEMO — ORDER NOW TO AVOID DELAY!!

NASCOM 2 — SYSTEM 80

MOST ITEMS EX-STOCK. PHONE FOR PRICES

VIDEO GENIE EG 3003 — 16KRAM

FULLY TRS80 LEVEL II COMPATIBLE!!

THIS READY TO GO SYSTEM ONLY £289.50

NEW-DOLPHIN BD80P PRINTER

PET/IEEE, PARALLEL OR RS232 INTERFACE BUILTIN.

UNBEATABLE BRITISH VALUE AT £525.00

SOFTWARE — 10C12's

PETSOFT 10.5 1/4" DISKS £25.00

BRISTOL 1000 SHEET OF PAPER £8.40

Software Factory, Commodore Business Software.

Wide range of books & manuals in stock.

Phone for keenest O.E.M. and educational user prices.

Please phone for carriage charges, all prices + VAT

cheques to Photoacoustics Ltd.

Riling Rod Eva for details or just call in at the BUSS STOP

255a St. Albans Road, Watford, Herts. (entrance in Judge Street)

Phone: Watford 40698 or Newport Pagnell 610625

• Circle No. 150

*Personal demonstrations available at all times in our new showrooms at
30 Lake Street. Also a large range of personal computers, books and
magazines. Barclaycard and leasing facilities available.*

EPSON PRINTERS

The TX-80 offers:

- 96 Ascii char. set and Pet Graphics
- 80 col 150/125 char/sec
- Condensed line, Enhanced print
- 5x7 dot matrix, 6x7 dot matrix for graphics

Prices starting from £395 including delivery.

Interface boards and cables available for Pet, Apple, TRS 80, IEEE488 and serial etc. for £45

OEM Prices available

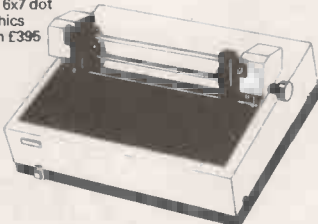

PERIPHERALS

PRINTERS

Texas Instruments Omni 810 Printer £1450.00

Paper Tiger Printer with Graphics £598.00

MONITORS

VM129 HITACHI 12" B&W Video Monitor £187.00

VM910 HITACHI 9" B&W Video Monitor £127.00

ACCESSORIES

Floppy Disk 5 1/4" Hard & Soft sectored pack of 10 £19.50

Floppy Disk 8" Hard & Soft sectored pack of 10 £22.00

C12 Computer cassettes pack of 10 £4.00

Computer Stationery on request

THE VIDEO GENIE SYSTEM EG 3003



At last, value for money in microcomputers.

£330 plus VAT

- * 16k User RAM plus 12k Microsoft BASIC in ROM
- * Fully TRS 80 level II software compatible
- * Huge range of software already available
- * Self contained, cassette, PSU & UHF modulator
- * Simply plugs into video monitor or UHF TV
- * Full expansion capability for disks & printer

LS. CHIP PRICES

| | |
|---------|-------|
| 74LS02 | £0.22 |
| 74LS08 | £0.22 |
| 74LS10 | £0.22 |
| 74LS32 | £0.30 |
| 74LS74 | £0.50 |
| 74LS86 | £0.45 |
| 74LS93 | £0.85 |
| 74LS100 | £0.20 |
| 74LS132 | £1.15 |
| 74LS138 | £1.05 |
| 74LS175 | £1.00 |
| 74LS191 | £1.30 |
| 74LS244 | £2.65 |
| 1485P | £0.95 |
| 1489P | £0.95 |

Memory Chips
4116 16K Dynamic Ram £6.40 for 8 £48.00

APPLE

HARDWARE

Apple 16K Video Output... £695.00

Disc Drive with Controller... £349.00

Disc Drive w/o Controller... £299.00

Pascal Language system... £299.00

Integer Card... £116.00

Eurocolour Card... £79.00

CCS Synch/Asynch Cards... £120.00

CCS Parallel Card... £90.00

SOFTWARE

Computech Purchase Ledger... £295.00

Computech Sales Ledger... £295.00

Computech General Ledger... £295.00

Computech Payroll... £375.00

Computech Utilities... £20.00

Plus Software from Databank and many more

TI 99/4

This TI Home computer helps take the guesswork out of problem solving, whilst also providing a "fun" way of education and giving stimulating entertainment for everyone. The TI 99/4 has all the features you have been waiting for only £995* complete with 14" colour TV with NTSC/PAL video input — or if sold separately TI console £665 and NTSC/PAL £375*.

Call CompUtopia for comprehensive price list. * Incl. VAT

Goods will be despatched within 24 hours of our acknowledgement giving precise delivery date. All prices include p&p within the UK. Please send cheques or postal orders or, if phoning your order, state Barclaycard number. For details please contact 30 Lake Street, Leighton Buzzard. Tel: (0525) 376600

• Circle No. 151

STACK COMPUTER SERVICES LIMITED



ARE YOU LOSING CONTROL ? Regain control with the Apple Computer.

We have developed a wide range of Apple interfaces and can provide scientific systems ranging from simple temperature monitoring to full closed loop control systems.

Our Apples can take data from B.C.D. instrumentation: e.g. mass spectrometers, gas analysers, laser gauges etc, Analogue devices - thermocouples, pressure transducers, photo detectors etc, etc.

Control includes both mains and low voltage switching units with safety defaults, multi-channel TTL I/O, and a variety of analogue output systems.

WE SELL APPLE TOO!

Even if control is not your problem our Apple-dedicated expertise should make us your first choice for Apple orientated products.

We have been supplying Apples since they first came into the country, maintain large stocks with fast delivery, and pride ourselves on being first with the latest Stateside products. Technical information and advice is freely available to all potential customers.

FOR FURTHER DETAILS PHONE PAUL FULLWOOD OR CARL PHILLIPS

WHAT'S NEW?

- * Super 'R' Terminal 80x24 Video card
- * Double Vision 80x24 Video Card
- * 4 Channel 8 bit D-A
- * 4 Channel low voltage relay board
- * 4 Channel mains switching unit
- * AIO combined serial and parallel interface
- * Z-80 Softcard
- * Anadex Printer Card
- * Apple III



Please add our name to your mailing list

to
**STACK-APPLE, 290-298 Derby Road, Bootle,
Liverpool. Telephone 051-933 5511.**

• Circle No. 152

THE SHARP MZ-80 COMPUTER SYSTEM

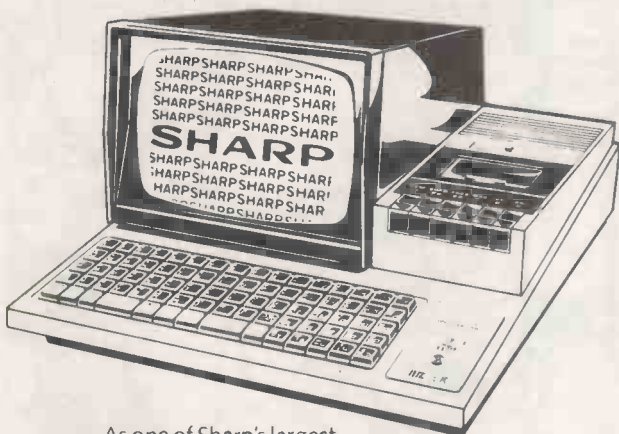

As one of Sharp's largest systems dealers we supply complete MZ-80 systems including FLOPPY DISCS and PRINTERS.

We have considerable experience in implementing SALES, PURCHASE and NOMINAL LEDGERS, PAYROLL, STOCK CONTROL, FOREIGN EXCHANGE and FINANCIAL PROGRAMMES.

Contact us now for details on 01-247 8506.



Stone House, Houndsditch Entrance
128-140 Bishopsgate
London EC 2M 4HX



• Circle No. 153

WEST Electronics MICROCOMPUTER REPAIRS

if your computer breakdown

TODAY

WE WILL REPAIR IT BY

TOMORROW

PHONE

051-653 8180

We carry thousands of components to suit most popular commercial and hobbyist micro's. Fully computerised test rigs ensure rapid accurate diagnosis.

KEEP THIS PHONE NUMBER DISPLAYED.
Trade and service agreement enquiries invited.

Cut around dotted line and retain ad for reference

• Circle No. 154

SOFTWARE FOR CP/M®

HIGH QUALITY SOFTWARE – WITH HIGH QUALITY SERVICE

WORDSTAR - Professional word processing software. On-screen formatting, wordwrap, pagination, line and character count on view. Micro-justification on daisy-wheel printer. Search and replace. Block/paragraph manipulation. External file read/write. Background printing during editing etc. £250

MAIL-MERGE - Wordstar enhancement for personalising documents. £80

CONFIGURABLE BUSINESS SYSTEM (CBS) - Unique information management system with user definable files, powerful report generator, menu-driven for ease of use. No programming experience necessary! £175

SELECTOR III - C2 - Information management system written in CBASIC-2. Maintains multi-key data base files and produces sorted formatted reports. Package includes simple application programs. £185

SELECTOR IV - Upward compatible enhanced version of Selector. Includes file format conversion, field computation, global search and replace, enhanced report formatter etc. £300

GLECTOR - Superior General Ledger application utilising the power of Selector £200

MAGSAM - Keyed file management system for use with CBASIC-2. An extended version of ISAM includes secondary indexing and deleted space reclamation. £130

ACCOUNTING PACKAGES by Median - Tec: PAYROLL, SALES, PURCHASE, £500

NOMINAL - Specially developed by UK software house to exacting specifications. Each Written in Microsoft Basic each package may be customised by end user, all are widely used. Ledgers are open item. Payroll caters for weekly and monthly pay.

PROJECT COST CONTROL - A comprehensive set of programs to monitor budgets, account for expenditure and project completion etc. Ideally suited for contractors. Written in CBASIC-2. £150

DATASTAR - Data preparation facility with screen form design, field validation, duplication etc. Menu driven. Compatible with CP/M and Wordstar files. £175

IBM - CP/M COMPATIBILITY - Powerful utility giving micro's the ability to act as IBM Data Preparation system with added benefit of micro processed data being available to IBM computer and vice versa. £110

CIS - COBOL - ANSI '74 implementation to full level 1 standard. Supports random, indexed and sequential files, features for conversational working, screen control, interactive debugging, program segmentation etc. £425

FORMS 2 - Automatic COBOL code generator for screen formats £100

CBASIC-2 - Extended Disk Basic pseudo compiler and run-time interpreter. Widely used for commercial packages £75

MICROSOFT BASIC INTERPRETER £195

MICROSOFT BASIC COMPILER £215

MICROSOFT FORTRAN COMPILER £270

STRUCTURED BASIC - Relocatable compiler combining the flexibility of Basic with the power of advanced structured techniques £140

SUPERSORT - Sort, merge and selection program £140

WORDMASTER - Full screen text editor £85

TEXTWRITER III - Text formatter with many features £80

STATISTICAL & MATHS ROUTINES - Over 40 useful routines easily used. £150

BSTAM - Telecomms facility for exchanging files between CP/M computers. Error detection and automatic retry with console messages. £75

Please contact us for availability of other products
All orders must be PREPAID. Add 50p per item P & P (Minimum £1) and VAT
*CP/M is trade mark of Digital Research



TELESYSTEMS LTD

P.O. Box 12, GREAT MISSENDEN, BUCKS, HP16 9DD

Telephone (02406) 5314

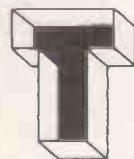

• Circle No. 155

Does your computer do exactly what you want?

Most of them don't. They use programmes that aren't sophisticated enough to adapt to a way of working that suits you best.

Now, though, there's a new programme called OZZ that's going to cause a revolution. It performs functions that are far from standard. It draws up file formats, stores and retrieves information, calculates, analyses and prints documents exactly the way you tell it to.

So at long last the computer is the quiet, ultra-efficient servant. And you are the complete master. Even if you've never been near a computer before. Now that's exactly what you want.

Contact:
BRISTOL SOFTWARE FACTORY
ST. MICHAELS HILL,
COTHAM, BRISTOL.
TEL: 0272 20801

TELEX: 449477

For the first time you're in complete control.

If only buying a microcomputer was as simple as using one

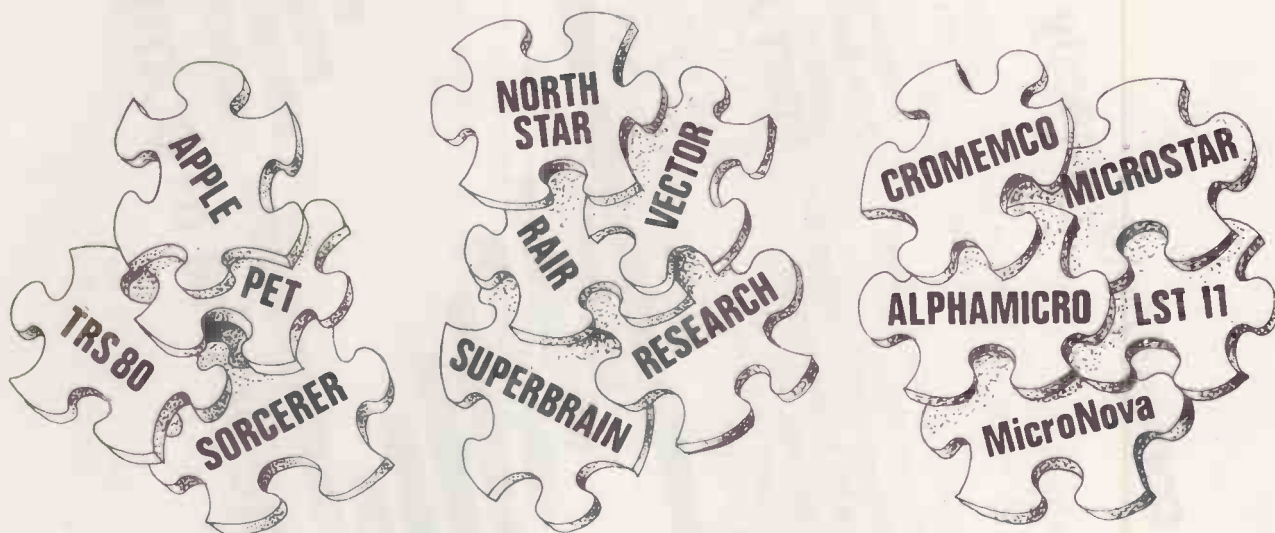

With so many micros to choose from, how do you select the best to meet your needs?

Just look at the advertisements in this magazine. When can you find time to digest them all?

There are millions of chips, thousands of boards and hundreds of peripherals, software systems and application packages. How do you pick the right ones to meet your requirements?

And put them together? And make them work? And add the specials you want?

At Digitus we have computer professionals working full-time putting systems together. Absorbing information. Testing equipment and software. Writing programs. Training users.

At one stop you can commission a complete system to fit your requirements.

Last year we supplied systems for: number processing, word processing, data processing,

graphics and machine control. Advised accountants, surveyors, archaeologists and engineers. Helped DP departments and small business men. Developed software for personnel, incomplete records, order processing, business games, linear programming, process control and terminal emulation. And were retained by other computer companies to advise on micros.

This year we can put even more experience to work so that you can benefit from micro technology ... in comfort.

Come and see us. Spend a few hours discussing your requirements. Attend a training course. Select a machine. Test drive some software.

Solve the micro puzzle. Buy an operational system that fits your needs.

Call for an appointment with one of our consultants.

Digitus

Alan C. Wood Digitus Limited 9 Macklin Street Covent Garden London WC2 Tel: 01-405 6761

• Circle No. 157

Waiting for Shakespeare

A REGULAR theme of this page is the difference between micro-computing and the mainframe business. Although we have inherited our basic techniques from them, we should not feel ritually bound by all the details of the big computer culture which has developed in very different circumstances to those in which we work.

One of the most important differences is in the interaction between man and machine. The big computer, generally speaking, was bought by executives who never actually worked on it, programmed by professionals, to whom it was important to preserve the mystique of computing, and operated by ill-paid young women who were hardly consulted about anything.

The result, it sometimes seems, was a jungle of gobbledegook thrown up simply to preserve the distinctions between those three classes of people. We, on the other hand, are in a very different position. The buyer, programmer and operator of our machines may very well be the same person.

What kind of thorn bushes have we inherited? Operating systems that are cryptic, arbitrary, give snappish and unhelpful error messages. CP/M, for instance, will say baldly: "DISC WRITE ERROR" if you try to write to a full disc, to one that has not been formatted or to one which has something wrong with it. Monitors are designed like intellectual obstacle courses. Their authors, like sergeant instructors in the army, evidently think that they would be letting the side down if things were made easy for the user.

Languages are designed to satisfy all kinds of exotic criteria rather than simplicity and ease of use. The books and manuals which explain them often make the implicit assumption that the learner must prepare himself for some deep-sea change akin to reception into a complicated and secret religion. The very first serious business system I ever had to do with made the user recover from a crash by typing "3DOGRUN". Quite apart from being very baffling and incomprehensible to the naive user, it had to be preceded by a "# — a useful piece of information mentioned nowhere in the manual.

Of course, things are difficult. The fruit of 30 years' esoteric work has to be taught to a whole generation who often know no more about microcomputers than that they are both too difficult to understand and absolutely essential for survival in the future.

However, many of the casualties could be avoided if people in the micro business had a clearer idea of the gulf between them and their customers. Unfortunately, like so many intellectual gulfs, it appears no bigger than a crack — until you fall into it. There is much the same gulf between the playwright and his audience.

You might think that there was no need for a theatrical profession at all. Shakespeare writes what Julius Caesar said, the audience reads the words and they have the whole thing at their finger tips. Why employ actors, directors, set designers, architects, ticket agents, reviewers — the whole huge entertainment business — to do what the play-goer can do for himself in the safety and privacy of his home?

Well, of course, it is not quite the same without the mummies. What is their business? It is to understand what the audience does not know and will not understand unless they are helped.

It is to help them in all kinds of subtle ways to understand in a way which will advance the play's development.

Much the same type of skill is needed in the writer of software. He must know what will puzzle people, what will seem illogical. He must design his systems so that they correspond to their users' thoughts and expectations. It is no good writing a stock-control package to the highest professional standards if it makes its users cross-eyed with frustration.

In short, we need a new art form. We are waiting for a Shakespeare who will interpret computing to the common man. Until he arrives and shows us what to do, we will have to bodge along as best we can.

Those thoughts were prompted by two matters of detail. The first is the imminent question of the 80-character VDU. The new Pets have it and other manufacturers will, no doubt, soon be offering this facility. Why? Because it is standard commercial practice. Is 80 characters better than 40 or 20? I do not think anyone knows.

I suspect that the 80-character screen was built originally to show ignorant but rich executives that the computer could do anything a piece of paper could do. An 80-character VDU gives the programmer altogether too much scope. He can create complete zerebas of fields, lines, reversed text, flashing cursors. He can make the screen so difficult to read that it makes some people seasick just to look at it.

My own feeling is that screens and pieces of paper should be treated as the very different things they are. A piece of A4 paper can hold about 350 typed words. You can see the overall shape of the thing, you can look closer at one paragraph, one sentence.

An A4 screen is a different matter. The material on it is fluid — it can come and go in the twinkling of an eye. Why make it pretend to be paper when it is electric? The great — or perhaps the only — virtue of the computer is its speed.

An eye-saving idea for data presentation came from Heinz Wolff at a seminar organised by Sperry Univac recently. He points out the absurdity of presenting complicated information as tables of numbers or even of bar graphs. He suggests a display like a cartwheel. Each variable has a spoke; the calibration along the spoke is chosen so that when things are in the normal state, the display make a circle. If things go wrong — the display might be of various physiological quantities measured from a patient in an intensive care unit — the display departs from circularity.

You could make heart failure distort the display in one direction, excessive urea in another, so that anyone could see at a glance what was amiss. Furthermore, if the display five minutes an hour, a day back is remembered, it can be shown in a different colour, or with hatching between it and the current curve. The display then also shows the patient's history.

There is a great deal of work to be done on finding the best interface between people and machines. The readers of *Practical Computing* are in a good position to do it; let us experiment with new ways of presenting and accepting information. The way the mainframe industry does things is not necessarily the best way. □

Microsystems 81

A call for papers has been issued for the Microsystems 81 conferences, sponsored by *Practical Computing*. They will be held at the Wembley Conference Centre, London, from March 11-13, 1981. Microsystems 81 is the fourth in a series of conferences and exhibitions designed for managers and engineers responsible for developing and using microprocessor-based systems. The final day of the conference will be devoted to personal computers and small business systems and their use in commerce, industry and education. Synopses of papers for consideration should be sent by the end of October to Microsystems 81, *Practical Computing*, Dorset House, Stamford Street, London SE1. □

Our Feedback columns offer readers the opportunity of bringing their computing experience and problems to the attention of others, as well as to seek our advice or to make suggestions, which we are always happy to receive. Make sure you use Feedback—it is your chance to keep in touch.

Proud ZX-80 owner

AS THE proud possessor of a ZX-80, I was impressed by your review of the creature, which gave the most thoroughly accurate description of its anatomy and habits I have read; better, for example, than the operating manual.

Having spent considerable time investigating the RAM contents, I can, perhaps, clarify some of the issues which you, also, discovered to be perplexing. First, the display file. As you will have gathered from the manual, the display file is not of constant size — in fact, during execution, it does not exist much at all until a print statement occurs, and enters something into it.

As if that were not enough, the location of the first item, invariably a new-line character, in the display file depends on the size of the variables file and the length of the program since the latter are stored in RAM locations preceding the display file.

Fortunately, the beginning of the display file can be found easily by Peeking at the appropriate systems variable, "D-FILE", which is found at addresses 16396 and 16397. Hence:

```
10 LET A = PEEK (16396) + PEEK (16397)
* 256
```

Naturally, if you instruct the computer to print the contents of the display file, you are, by virtue of the print statement, enlarging the display file to include a copy of itself, and a copy of a copy of itself, and so on.

I suggest that this is why you concluded that the program lines were repeated over and over in the RAM: the program listing was resident in the display file immediately before RUN was entered so, inevitably, the program listing multiplied itself in the display file as described.

There is, however, an easy way to avoid that; the initial part of the program must fill the display file with blanks, so that the program listing is cleared immediately and, as an added bonus, the file is then confined to stay of fixed size which can be very helpful when your trying to POKE into it, e.g.,

```
1 FOR A = 1 TO 92
2 PRINT,
3 NEXT A
rest of program.
```

Do take note of the particular format of the print statement in line two since the punctuation comma is very important and a print statement on its own is not adequate since it would only insert new-line characters, code 118, but no blanks, code 0.

To stop the display file wandering, which is also a good idea if you want to Poke into it, it is necessary to establish the variables file as an initial step. That can be established by naming all the variables which you wish to use in the first few program lines, i.e., before any Peeking and Poking is done, e.g.,

```
4 LET X = 0
5 LET Y = 0
6 LET Z = 0
```

It also pays to place randomise near the beginning of the program if it will be required during the run.

Armed with that, it is amazingly straightforward to Poke into the display file and the vain among us can even pretend we are fully memory-mapped. One word of warning — watch out for those 118s, the new-line characters.

If you delete them, weird and wonderful effects are displayed on the screen. Of course, the situation is restored easily by Poking them back again if you accidentally delete one or two. The first, and every thirty-third, character in the file is one of these.

Finally, with reference to loading from tape, I have found that much depends on the quality of the tape, rather than the cassette player, and I have had some success with an Ever Ready Super C-60.

However, the recording seems to be very prone to mutilation after being played back a few times — even though it sounds the same to the ear — and demagnetisation of the playback head may well be indicated as a worthwhile measure.

In all other respects, however, the ZX-80 is very reliable and much more versatile than apparent at first glance. However, for any good graphics games, the memory expansion board 1K is just too small.

Laurence Richardson,
Cardiff.

Plessey micromouse

WITH reference to the Micromouse article in September, as a member of the Plessey Mouse Team, I feel that a few points are in need of clarification.

Plessey's involvement in the project has been purely on a financial basis. Companies other than Plessey have also expressed interest in the competition in terms of financial sponsorship for their work teams — hence the event has become one of prestige value.

The cost of our project has probably been no more than that of the independent Marconi entrant, for example, and,

therefore, in the financial resources aspect, we have had no distinct advantage.

The work on the project has been carried out in our own spare time. In fact, 95 percent of all mechanical work has been done on my kitchen table, and all electrical work in my bedroom.

It will be seen, therefore, that we have not had the advantage of the many resources available to us which the article implied.

The deciding factor in the quality of any project, be it a mouse or otherwise, can be only the engineering ability, experience and ingenuity of the design team, coupled with the amount of work put into it.

Martin Hayman mentioned Algernon's slick tyres as "a lateral thinking approach to traction which others might consider". Whatever happened to stiction being a function of load versus surface area, in conjunction with the frictional co-efficient of the tyre material?

M Buckland,
London N13.

Adventure II assessed

I READ with great interest the article Adventure II in the August issue and found it well done overall. The program could form a useful and flexible standard which would allow the creation and exchange of some worthwhile games.

However, I feel that the program as given has a few faults of a minor nature and a few omissions of a more serious nature.

On the addition side, I should like to see available three extra actions: increment flag 'N'; PUSH 'Here'; POP 'Here'. The ability to increment any flag allows more flexibility in timing, and would permit a scoring system and accumulation of light wounds as in XORK/DUNGEON.

The PUSH and POP actions would allow movable chests, socks, caskets etc., i.e., objects which are both locations and objects. Using them to extend created objects allows re-setting parts of the complex of location-independent stimuli — after time delays or on an action, etc. — and they can also be used to inhibit movement, if we are in combat for example.

As for the minor faults, I doubt the general utility of the dedicated flags three and four and feel that a counter used for

(continued on page 44)

SIX OF THE BEST

Pet Programs from Petsoft

76 BASIC PROGRAMS

76 COMMON BASIC PROGRAMS

A collection of 76 useful programs on one cassette from Adam Osborne's best selling book. These include personal finance, maths, statistics and general interest topics. Excellent value for stand alone or incorporated use.

£15 on cassette.

STOCK CONTROL

STOCK CONTROL Powerful and flexible stock system with full facilities for recording and control of stock information. An audit listing is automatically printed which itemises all transactions including the entry amendment and deletion of master stock information, issues receipts, allocations, purchase orders. Printed reports include Full Stock Control, Stock Valuation, Reordering Report, Audit Listing, The system is highly flexible.

£50 on CompuThink or Commodore Disk.

WORDCRAFT

WORDCRAFT A true Word Processor for the 32K PET. Wordcraft is a genuine word processing system, easy to understand and use, but containing all the facilities normally found only on more expensive dedicated Word Processors. Features include scrolling in both vertical and horizontal directions (to overcome small screen size), up to 117 characters wide and 98 lines deep for a full page of text. Written entirely in machine code for speed and compactness. Truly the Rolls-Royce of PET Word Processors.

£325 on CompuThink or Commodore Disk.

PAYROLL 200

PAYROLL 200 Comprehensive, easy-to-use package for small businesses with up to 200 employees. Facilities provided include Holiday Pay, Sick Pay, Bonus Payments and two rates of overtime, as well as allowing a 'Standard week' to be specified for each employee. Weekly and monthly summaries are provided and amendments necessary because of a Budget are made very easy. Prints wage slip and coin/note analysis. Tax & NI are computed automatically from knowledge of employees codes. Update service available. Full manual provided.

£50 on Commodore or CompuThink Disk. Cassette system also available at £25

PETPLAN BUSINESS SIMULATION

PETPLAN BUSINESS SIMULATION

PETPLAN is a general management business simulation game which is exciting to play. Already it is widely used by colleges and Industrial Trainers to teach the skills needed to run a business. The program creates the model of a manufacturing company; you take the decisions. You will need to hire workers, invest in plant and premises, set advertising budgets and prices. At each stage screen reports (which may be printed out) show the results of decisions as they take effect. 50 page manual and voice guide on cassette. For 32K PETs.

£60 on Cassette.

PET BASIC TUTORIAL

PET BASIC TUTORIAL 2 A revised version of our best selling course on programming the PET in Basic. Let PET take you through its commands and functions at your own speed. Over 50K of lessons including working examples of the programming techniques that are described. Suitable for novices and those with some programming experience, from literacy age 10 on.

£15 on cassette.

PROGRAMMERS TOOLKIT £44

Plug-in ROM Chip adds nine useful commands to PET BASIC including RENUMBER, TRACE, DUMP, FIND and APPEND.

You will find Petsoft programs on sale in more than 200 computer shops throughout the country, and in many more all over the world. We invite you to try them.

If you can't find the program you need, contact us directly. We offer over 200 titles and can supply you directly. We will even take credit card orders over the telephone. Since we normally carry all programs in stock, you won't have long to wait.

PET is the trademark of Commodore.

Petsoft is backed by the resources of Applied Computer Techniques Ltd., Britain's leading computing group. With over fifteen years experience of developing business software, ACT has a reputation second to none in the industry. That is your guarantee.

If you would like more information on any of the programs mentioned on this page, clip out the coupon. We will see that a free copy of our complete PET software catalogue reaches you without delay.

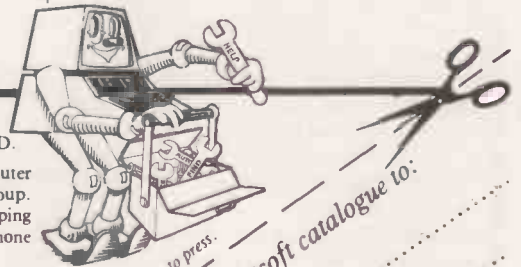

Petsoft

part of the ACT
Computer Group



Radcliffe House, 66/68 Hagley Road, Birmingham B16 8PF

Telephone 021 455 8585

Telex 339396

Prices exclude VAT and were correct at time of going to press.

Please rush a FREE copy of the latest Petsoft catalogue to:

Name:

Address:

Postcode:

I have an

- 8K PET
- 16K PET
- 32K PET
- No PET yet

• Circle No. 158

(continued from page 42)

the lifetime of a lamp would be of more general use.

That criticism may be considered more than minor if we do not allow increment flag when we are stuck for timing, apart from using long lists of testing flags and setting flags entries in the status table.

Other minor limitations include the lack of limit testing on the computed GOTO intructions which could make testing of a database in development troublesome.

The complex problems of general purpose parsing and vocabulary were very well tackled. Although a condition: is the next keyword 'N'? might be useful.

Even if we take the program as a standard without further ado, we are not out of the woods. Since the database is not re-locatable in its normal form, there will be difficulties because for virtually all proposed positions, someone may have his monitor there or all his parts or his memory-mapped VDU. A re-location program need not be very difficult but we still have the problem of tape interfaces and formats.

While discussing the database I must take issue with the statement that fixed lengths — meaning fixed origins — for the tables will be inefficient in memory range. Since the text strings and the condition, movement and action lists are referred to only by absolute pointers, they may be used to fill in gaps very effectively, if not exactly neatly.

We now require a database-exchange network and I look forward to seeing it and the fruits of its operation.

CD Southern,
Chalfont St Giles,
Buckinghamshire.

RND functions

MAY I add a little to Peter Drew's letter in the July issue of *Practical Computing* on the Pet RND functions?

I started to investigate RND when I obtained unacceptable results for the simulation of the scores on two dice thrown many times. I tested various RND functions by generating random digits and using three types of test:

- A significance test for the mean — the expected mean is, of course, 4.5.
- A Chi-squared test for the frequency of the digits.
- A runs test. Runs tests detect patterns in sequences, e.g., a function generating a random selection of zeros and ones might produce the following two sequences:

```
0000011111
1010101010
```

both of which satisfy the first two tests but would fail a runs test because of insufficient runs of digits in the first sequence and there are too many in the second.

A further consideration is the time it takes to generate the numbers. The table shows how some of the functions fared in

my tests and gives the time taken to generate 1,000 random digits.

| | Test 1 | Test 2 | Test 3 | Time in seconds |
|-------------------|--------|--------|--------|-----------------|
| RND (0) | x | x | x | 10.9 |
| RND (1) | ✓ | x | ✓ | 14.5 |
| RND (RND(0)) | ✓ | ✓ | ✓ | 15.0 |
| RND(RND(-RND(0))) | ✓ | ✓ | ✓ | 16.2 |
| F% | ✓ | ✓ | ✓ | 51.3 |

Note: F% is Peter Drew's generator.

2000 F% = STR\$(RND(1) * LOG(T1))

2010 F% = VAL(MID\$(F%, 8, 1))

All the tests have been repeated, often several times. Tests one and two were based on 250,000 random digits for each function and took a long time to execute, e.g., 89 minutes on RND(1).

I am satisfied that for the generation of a large number of random numbers, RND (RND(0)) produces numbers which pass the tests for randomness and is faster than some other random number functions which also pass the tests.

Paul Gibson,
Mitcham,
Surrey.

Important issue

AS IT seems impossible to borrow a copy of the first issue of *Practical Computing* from any public source, may I ask any reader who has a copy of *Practical Computing* Volume number 1 July/August 1978, and is willing to loan it for a few days, to contact me?

Reginald Mascal,
Berkeley Nuclear Laboratories,
Berkeley,
Gloucestershire, GL13 9PB.

Prime and Apple II

I AM interested in using an Apple II as a dumb terminal to a Prime 550 mainframe using a direct line and the Apple high-speed serial interface card.

I have established some communication but there are still problems — mainly the loss of the first few characters of any message from the Prime. I am also having problems with any speed greater than 300 baud.

As a further project, I would like to use the Prime disc store from the Apples. Has anyone overcome any of these problems?

Tim Gerrish,
Plymouth Polytechnic,
Plymouth.

Mainframes and micros

YOUR editorial of June, 1980 was a thoughtful piece on the very important subject of how far methods from the mainframe computer world should be carried into the micro world. Unfortunately, you spoiled it by discussing the wrong things and lost credibility by making one completely flabbergasting statement.

You said you "have a young friend who wrote 5,000 lines of debugged machine

code in two weeks". Do you also know someone who has done a 500 ft. high jump?

Later, you mention that "micros have put computing back 15 years" but argue this be true for the wrong reasons. The real reasons are: many programs on micros simply don't work properly; they hardly ever have more than derisory documentation.

At this point I ought, perhaps, to declare my interest. I have been in programming, systems and design on all kinds of computers since 1955.

As evidence on the first point, I have dipped into a book of published Basic programs at several places and, in every single case, found an error just by reading the code — heaven knows that bugs would crawl if you keyed-in and ran these programs.

On your discussion of a suitable programming language, the choice of topics was very lop-sided. Recursion is an important subject in the theory of computer science, but nobody would demand it in a popular programming language, certainly not for business.

Then you stress the need for localised variables in programs 30,000 in size, and dismiss it for micros. That comment is wrong in several different ways. First, a program is large from the point of view of structure if it is more than 20 or 30 lines, because that is about the maximum a human can hold as a complete totality in his or her head.

Secondly, it is by no means the case that microcomputer programs are smaller than those on larger computers.

Thirdly, it is the linking of programs together which is important not just whether variables are local. The many pathetic re-number utilities prove that this problem is known, but they do not approach a solution.

You do not mention the most common criticism by outside programmers looking at micros. It is how can you possibly manage with all that 'S1=S2 and 'goto 51347' when I can use names like 'QUANTITY-IN-STOCK'?

Finally, there is the point I believe to be most important of all — the inadequacy of subroutine mechanism. The language ought to encourage programs to be built top-down — main routine on one page, calling each section as subroutine etc.

In fact, it deters, because of the clumsiness of having to assign values as arguments before each GOSUB and assign the results again after it. The DEF FN allows parameters but one cannot use the call instead of GOSUB, because a multi-line function is not allowed.

That is the only case where I have found a superior feature in Basic on mini and mainframes — usually the micro Basic is better. There are other major problems in subroutine control, e.g., in stock handling and use of ON ERROR.

P Shackleton,
London, NW6. □

LENTERPRISES

MAIL ORDERS, VISITS,
TRADE ENQUIRIES
WELCOME CREDIT
CARD ORDERS
ACCEPTED BY
TELEPHONE/TELEX
Payment must be in
sterling, on a UK bank.

Room PC
11, Cambridge House
Cambridge Road
Barking, Essex
IG11 8NT England
Tel: 01-591 6511
Telex: 892395 LPRISE

BOOKS/MAGAZINES/SUBSCRIPTIONS

BY OSBORNE

| | |
|---|--------|
| Introduction to Microcomputers Series | |
| Vol 0: Beginners Books | £8.95 |
| Vol 1: BASIC Concepts | £8.30 |
| Vol 2: Some Real Microprocessors (without binder) | £18.95 |
| Vol 2: Some Real Microprocessors (with binder) | £24.70 |
| Vol 2: Updating supplement set Nos 1-8 | £18.95 |
| Vol 3: Some Real Support Devices (without binder) | £11.95 |
| Vol 3: Some Real Support Devices (with binder) | £17.70 |
| Vol 3: Updating supplement set Nos 1-8 | £18.95 |
| 1 Binder (Specify for Vol 2 or 3) | £5.75 |
| 1 Updating supplement (Specify for Vol 2 or 3) | £4.00 |
| PET and the IEEE 488 (GPIB) bus | £3.95 |
| 6800 Programming for Logic Design | £8.30 |
| 8080 Programming for Logic Design | £8.30 |
| Z80 Programming for Logic Design | £8.30 |
| Z80 Assembly Language Programming | £8.15 |
| 6502 Assembly Language Programming | £18.25 |
| 8080A/8085 Assembly Language Programming | £7.95 |
| 6800 Assembly Language Programming | £7.95 |
| Accounts Payable and Accounts Receivable | £13.15 |
| Payroll with Cost Accounting | £13.50 |
| General Ledger | £12.25 |
| Some Common BASIC Programs | £7.95 |
| Running Wild | £2.50 |

MAGAZINE BACK ISSUES

| | |
|---------------------------|-------|
| Micro 6502 Journal | £1.75 |
| Personal Computing | £1.95 |
| Interface Age | £2.95 |
| Dr Dobbs Journal | £1.95 |
| Computer Music Journal | £3.75 |
| Recreational Computing | £1.95 |
| BYTE | £2.95 |
| Creative Computing | £1.95 |
| Calculators and Computers | £1.95 |
| Kilobaud Microcomputing | £2.95 |
| Compute - for the 6502 | £1.95 |

| | |
|-----------------------------------|-------|
| 68 Micro | £1.95 |
| 80-Microcomputing | £2.25 |
| On Computing | £1.95 |
| Compute II - for the Single Board | £1.95 |
| Magazine Storage Box (Holds 12) | £1.50 |

MAGAZINE SUBSCRIPTIONS (all processed within 3 weeks)

| | |
|-----------------------------------|--------------------|
| Micro 6502 Journal | (12 issues) £13.50 |
| 68 Micro | (12 issues) £17.50 |
| Personal Computing | (12 issues) £17.50 |
| Interface Age | (12 issues) £25.50 |
| Dr Dobbs Journal | (10 issues) £15.00 |
| Recreational Computing | (6 issues) £10.50 |
| BYTE | (12 issues) £25.00 |
| Creative Computing | (12 issues) £17.00 |
| Kilobaud Microcomputing | (12 issues) £22.00 |
| Compute for the 6502 | (6 issues) £10.50 |
| 80 Microcomputing | (12 issues) £21.00 |
| Compute II - for the Single Board | (6 issues) £10.50 |

FOR THE 6502

| | |
|--|--------------------|
| See Magazines and Subscriptions! | See Osborne Books! |
| Micro 6502 Journal | £5.50 |
| Best of Micro, Vol 1 | £5.50 |
| Programming the 6502 (Zacs) | £7.95 |
| Programming the 6502 (Faster) | £8.75 |
| 6502 Applications | £7.95 |
| 6502 Software Gourmet Guide and Cookbook | £7.25 |
| 32 BASIC Programs for the PET | £10.10 |

FOR THE 8080

| | |
|--|-------|
| See Osborne Books! | |
| 8080 Programmers Pocket Guide | £1.95 |
| 8080 Hex Code Card | £1.95 |
| 8080 Octal Code Card | £1.95 |
| 8080 Software Gourmet Guide & Cookbook | £7.15 |

| | |
|--|--------|
| 8080/8085 Software Design | £8.75 |
| 8080 Standard Monitor | £3.95 |
| 8080 Standard Assembler | £3.95 |
| 8080 Standard Editor | £3.95 |
| 8080 Special Package: Monitor, Editor, Assembler | £20.00 |
| BASEX: A Simple Language and Compiler for the 8080 | £5.50 |

FOR FUN

| | |
|--|-------|
| SARGON - A Chess Game | £3.50 |
| BASIC Computer Games | £5.00 |
| More BASIC Computer Games | £5.50 |
| What to do After you Hit Return | £8.95 |
| 8080 Galaxy Game | £8.95 |
| SUPERWUMPUS - A game in 6800 Assembler Code & BASIC | £4.25 |
| Computer Music Book | £8.75 |
| Computer Rage (A board game) | £8.95 |
| Artist and Computer | £3.95 |
| Games, Tricks and Puzzles for a Hand Calculator | £2.49 |
| Introduction to TRS-80 Graphics | £5.75 |
| Take My Computer Please (Fiction) | £3.25 |
| Introduction to Low Resolution Graphics for Pet, Apple, TRS8 | £5.50 |
| Starship Simulation | £4.50 |

FOR THE NOVICE

| | |
|--|--------------------|
| See Magazines and Subscriptions! | See Osborne Books! |
| Your Home Computer | £5.95 |
| Getting Down to Business With Your Microcomputer | £5.50 |
| Introduction to Personal and Business Computing | £5.50 |
| Getting Involved with Your Own Computer | £5.50 |
| How to Profit from Your Personal Computer | £6.50 |
| Microcomputer Potpourri | £1.95 |
| Hobby Computers are Here | £3.95 |
| New Hobby Computers | £3.95 |
| Understanding Microcomputers and Small Computer Systems | £6.95 |
| Understanding Microcomputers and Small Computer Systems and Audio Cassette | £8.75 |
| How to Make Money with Your Microcomputer | £5.75 |
| From the Counter to the Bottom Line | £10.00 |

• Circle No. 159

Does your microcomputer suffer from hiccups?

If so, quite often the cause of irregular performance or breakdown is very simple.

It's probably a high voltage spike in the electricity supply, called a transient, affecting the performance. Heavy electrical loads in the vicinity of your microcomputer (from domestic electrical appliances to office photo-copiers) can often cause voltage transients, which in turn, play havoc with both hardware and software.

The Reguvolt 'P' Model Constant Voltage Transformer provides the answer to a very simple yet aggravating problem, offering the following benefits to safeguard your supply sensitive computer and equipment.

- Transient suppression — gives software and hardware protection.
- Brownout protection — prevents micro interruptions and system crashes.
- Isolated secondary circuitry — gives complete electrical isolation between mains and computer.
- Fast voltage stabilisation — prevents VDU screen drift and complete system failure

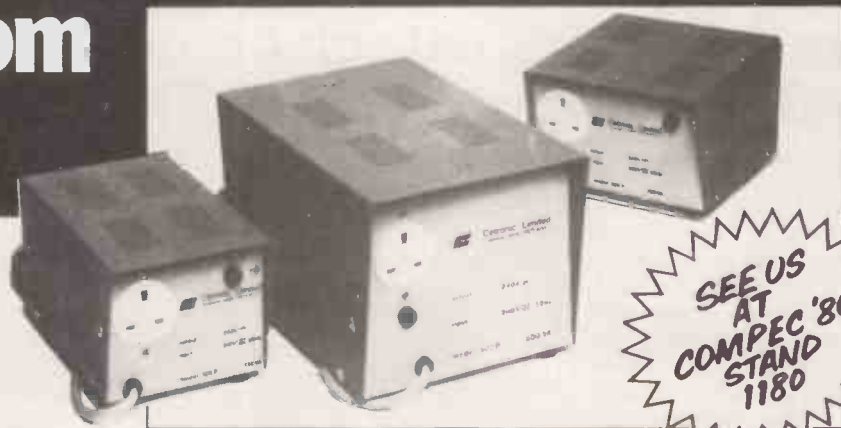

SEE US
AT
COMPEC '80
STAND
1180

- Automatic overload current limited — protects equipment against damage during a fault condition
- Low frequency mains harmonics removed, preventing VDU flicker and circuit overload.

The complete range of Reguvolt 'P' models, from 1/2 to 2 amp ratings (ie. 120VA to 500VA) are available from stock.

Should you require further details, please fill in the coupon, or, if you prefer, give us a call.

Cetronic Limited
Hoddesdon Road, Stansted Abbots
Ware, Herts SG12 8EJ, England
Tel: Ware (0920) 871077 Telex: 817293

Please send me further information on your range of Reguvolt 'P' Model Constant Voltage Transformers.

Name _____
Company _____
Address _____
Telephone _____

• Circle No. 160

ZX-80 wins extra power from latest add-ons

TWO NEW add-ons designed to expand the capabilities of the Sinclair ZX-80 have just been announced by Science of Cambridge. At their launch, inventor Clive Sinclair claimed that the ZX-80 is now out-selling all the other personal computers combined in the U.K. market. The new products are a high-level, full-facility 8K Basic RAM, at £19.95 and a self-contained 16K RAM pack at £49.95.

To date, 17,000 ZX-80s have been sold and units are manufactured at a rate of 300 a day, increasing to 500 at the end of the year and 40 percent are exported; particularly to the

U.S. via the Sinclair office in Boston. Exports are expected to reach 70 percent over the next six months as new overseas markets, such as Sweden and Australia, are tackled.

The 8K Basic ROM, designed as a drop-in replacement for the existing 4K Basic ROM, has a new keyboard template and a supplementary operating manual. Key features of the new Basic include a full floating-point arithmetic to nine-digit accuracy, logs, trigs and their inverse functions, a graph-plotting facility, an animated display using PAUSE n, a full set of string-handling facilities,

n dimensional arrays, n dimensional string arrays and cassette Load and Save with named programs. No less than 37 new functions are available with one keystroke; e.g., Draw, Data, Arcsin, Val and Scroll.

The plug-in 16K byte RAM is a complete plug-in module which can be used as a database or for program storage. According to Clive Sinclair, it costs up to half the price of competitive additional memory. The module plugs into the existing expansion port on the rear.

In answer to complaints from users, Clive Sinclair tells *Practical Computing* that the delivery problem — a constant source of complaints for some weeks — has now been solved. He says: "When we first advertised the product, we had no idea of what the response would be and, in fact, it was miles ahead of expectations. We had planned delivery time for four weeks. At one point, it rose to nine weeks but we have re-phased our production and it is now back to four weeks or less for assembled models".



Tandy begins attack on market for pocket computers with Sharp deal

TANDY is making a new attack on the lower end of the computer market by an OEM deal with the Sharp Corporation allowing Tandy to market the Sharp PC-1211 pocket computer, reviewed in *Practical Computing* in July, under the name of Radio Shack. It will be sold through the Tandy stores.

The computer has 1.9Kbytes of RAM and 11Kbytes of ROM and has a cassette interface for extra memory. The price of the model will be £119 for the computer and £17.95 for the cassette interface. The Sharp version is now being advertised at £85 and £11.50 respectively.

In the middle of next year, Tandy plans to launch a new computer, to be called the Model III. It will be a colour

computer with an integral keyboard, screen and dual 5¼in. disc drives, to fill the gap between the Model I and the more recent Model II. In the

meantime, however, Tandy has opened its first store in Scotland in the centre of Glasgow and plans to open another in Edinburgh in a few weeks.



Less weight, more space

FLEXIBLE copper-clad laminates have been introduced by 3M. Flexible circuits are replacing conventional wiring looms or cable harnesses in many electrical and electronic applications because of their advantages in space and weight.

The CuFlex consists of a flexible epoxy/polyester resin, reinforced by an organic fibre non-woven web. It has all the properties of traditional printed circuits. Details from 3M on (0344) 58436.

Why people buy micros

A MANCHESTER-based market research group is starting a study into the reasons why people buy microcomputers. The aim is to assess how the people choose between competitive systems. The survey will not start until the company, BDA, has found enough companies or dealers willing to spend up to £1,000 each for a copy of the report.

The study will be strictly qualitative and in the words of Tom Burgess, one of the directors of BDA, will rely on "motivational research techniques" which will "probe beyond the level of the conscious mind".

One of the techniques used will be to invite dealers and past customers to interact: "Interaction brings out points which other research techniques miss", says Tom Burgess. Details from BDA on 061 228 3768.

MTC Pilot guides Pet to computer-aided teaching

A 6502 machine-code program for the Commodore Pet has been released by Mitac Publishing Ltd.

MTC Pilot is an adaption of common Pilot run as a machine-code interpreter for the Mark II Commodore Pet. All the features of common Pilot are supported, including full matching, automatic editing of user input, execute-indirect and file-input and output commands, and escape and

go to options. Additional features are special Pet graphics commands, extended string handling and string arrays, and Peek and Poke instructions as in Basic.

By using subroutines in the Pet ROMs, the program runs in 4K of machine code. This code re-locates to the top of the available Pet RAM.

Mitac Publishing hopes the new Pilot will find a market in computer-aided teaching and

computer science courses. The interpreter, manual and a number of sample programs are available, at £65 plus VAT, from Mitac Publishing, Modern Tutorial College, Kilburn Lane, London W10 4AA.

New low price starts Superbrain storm

A PRICE war has broken out among dealers of the much-acclaimed computer from Intertec, the Superbrain, reviewed in *Practical Computing* in April this year. Most dealers were advertising the system at £1,950 and were taken by surprise when a new company, KGB Computers, started offering to sell it for £1,495 — a full £500 cheaper.

According to Bill Horse, managing director of Slough-based KGB, he had not expected such a stormy reaction. "Dealers were telephoning again and again — some of them very angry. Before we entered the market there were about 40 dealers selling the Superbrain, all around the same price, and the total sales were averaging around 80 to 100 systems a month. We seem to have doubled the market, selling about 120 systems per month ourselves".

Bill Horse says several dealers have offered to talk about a common pricing policy — a move which he has so far declined.

The entry of KGB into the Superbrain market seems to have been well considered. Bill Horse also runs a company called Plus Business Systems, one of the recently-appointed Alpha Micro dealers: "We were convinced that there was a market at the lower end, and not just for the Apples and Pets.

We asked people about

the Superbrain and they all agreed that it is a good system but that there were some reservations about the price".

The Superbrain retails in the U.S. for about £1,200 so unless the new price becomes accepted, Bill Horse feels that it would be cheaper for most people to fly to the States, buy one and bring it back themselves.

The Kingston Netkit broadens the capabilities of the Pet by freeing it from many of the limitations associated with the creation of RS232C serial via the IEEE 488 port. It is a hardware/firmware package which allows a relatively inexperienced programmer, assisted by 10 new serial Basic commands to achieve configurations without recourse to machine-code routines. The kit serial port on the Pet can not only exchange data and program files freely but also be remotely-controlled and simplifies multi-access use of the Pet. Details from Kingston on (0262) 73036.

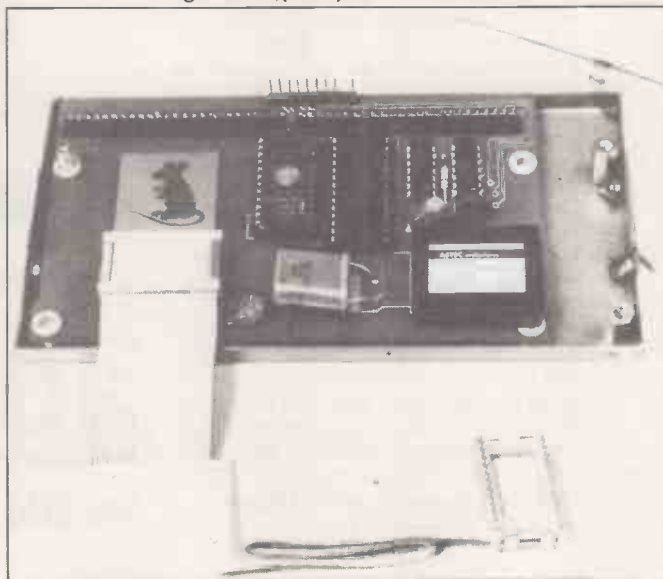

Vero extends Eurocard

VERO Electronics has extended its Eurocard range to include a fully-pierced Eurocard Vero-board, available with or without a maximum copper colander ground plane.

Another new product from Vero is an addition to the Eurocard power supply range with a 5V at 5A single-output unit. Details on (0703) 440611.

Recession could lead to boom in computing

THE RECESSION is beginning to bite, unemployment has topped two million and seems to be increasing at an ever faster rate. One way and another, it looks like being a hard time, especially for small companies. Most forecasters expect the recession to hit a trough between the last quarter of this year and the first quarter of 1981. Even then, the recovery should take quite some time to emerge.

From the gloom, there is, however, some good news. According to London stock-brokers Hoare Govett, work-

ing on figures published by the Government Central Statistical Office, capital investment in increasing and while companies are shedding their labour force, they are turning to new plant machinery and technology as ways of increasing their efficiency.

The figures for capital investment have been buoyant for some time. If all the figures are kept at 1975 prices, there has been an 11 percent increase in the volume of investment each year for 1977, 78, and 1979 and the trend seems to be continuing into 1980 with another 11 percent increase in the first quarter of 1980 over the same period in 1979.

According to analyst Tony Barron, while labour costs have risen by as much as 20 percent over the past year the cost of capital equipment — such as microcomputers, especially when imported as the pound is still holding strong against the dollar — has risen on average by about 2 percent. In other words, the recession could lead to a boom in microcomputing.

Hoare Govett use the figures to help explain why the Government has found it so hard to control the money supply, arguing that it is these crash investment programs, with companies borrowing heavily for finance, which have kept the money supply figures so far above target.

The recession is expected to bite so hard that there will eventually be a small decline in investment at the end of the year, but a quick recovery is forecast in the first four months of 1981.

Get the latest on PET...



Dial 01-579 5845.

Adda make it their business to get in first on all that's best and new in PET hardware and software... and in finding out how to make the latest advances work more profitably for you.

All the advice, assistance and arrangement of demonstrations you could ask for are there for the taking. And that's just for starters. Long term Adda look after your future requirements with software, full engineering support and maintenance contracts that can include machine loan.

In addition to the 16k PET 3016 and 32k PET 3032, Adda offer you the new 32k PET 8032—with 80 columns, 12-inch screen and a keyboard that really gets down to business. Recent advances make possible some exciting applications for these mighty micros.

Link the 32k PET up to the Wordcraft word processing program and you have a very sophisticated word processing system for less than £4000. It's a word processor and more—because it can also be used as a small business machine.

The Wordcraft program comes on a mini floppy disc ready for use on a Commodore 3040 diskette drive. The whole system gives you word processing to standards achieved by expensive

purpose-built machines; and you can use a large selection of output printers including dot matrix, golfball and daisy wheel. So much for words—now for some action: phone 01-579 5845.

If you're looking for mainframe access, the Communicator 1 mainframe-PET link enables file transfer to be made in both directions... with a PET Communicator system configured with either dual floppy disc or cassette tape drive and a printer.

Files transferred from mainframe to PET can be manipulated locally and data transfer monitored on the PET screen. It's a fast way of cutting costs on bureau time share—and it also doubles up as a fast normal terminal. The Communicator 1 mainframe-PET link paves the way to big cost savings. Your first step is digital input to 01-579 5845.

More cost savings can be realised when you link up three to eight PETs to one Commodore disc drive and a printer using Mu-pet (Multi-User PET)—and you don't have to make any program changes. As a Mupet dealer, Adda can put you fully in the picture. Just phone 01-579 5845 for a demonstration of Mu-pet being put through its paces.



adda

Adda Computers
14 Broadway
West Ealing
London W13 0SR
Entrance in
Kirchen Road

we add up to a great deal.

• Circle No. 161

Easy software transfer

SCIENTIFIC micro-builders Research Machines of Oxford has announced that the Computer-Assisted Design Centre well-known GINO-F, GINO-2D and GINOGRAF packages will be released for the 380-Z later this year.

The various GINOs are rather like CP/M in that they provide a standard interface between the high-level software and the machine's hardware. GINO provides the writer of a graphics package with a number of basic visual resources.

If he wants to draw a circle, for example, he just has to tell GINO the centre and the radius. That not only makes his life much easier, it means that graphics software can be transferred from one machine with GINO to another. □

Expansion for Superboard

A NEW expansion system for the Superboard and UK101 has been developed by Zen Computer Services. The basic system consists of two boards with a 40-way jumper lead to the main computer board.

OSI systems boards which can be run include both static and dynamic RAM, 8in. floppy-disc controller and a range of I/O options. Price of complete system is £43.70. Details from Zen on 061-962 3251. □

A NEW version of the LX-500 computer has been released by LogAbax. It has dual-density discs and will sell for £3,500. According to LogAbax, the LX-500 is "no bigger than a shoe-box". Details from LogAbax, 01-965 0061. □



Microspeech 2 gives vocal support to progress in voice synthesis

SOUND AND voice boxes are becoming popular at last. The latest offering, Microspeech 2, is a stand-alone speech-synthesising unit which converts phonetic code, or English text into speech output, via a

standard RS232 interface.

The speech is created from the unit's microprocessor so all that is required is an ASCII keyboard. Up to 1,000 phonetic characters, representing one minute of speech, can



be assembled in its internal buffer before it is commanded to speak.

The optional text-to-phonetics translator program includes the phonetic equivalents of all the standard ASCII symbols and thus enables the units to be driven directly from English text, although the speech in this mode is less fluent. The unit is still expensive, however, at £875 plus an extra £75 for the English-text version.

The software was written by Richard Monkhouse and the hardware and the synthesising was designed by Tim Orr of Tim Orr Consultants. Tim Orr is frank about the high cost of the system and its sales potential: "We are only really going for people who are not spending their own money. Sales so far are from the Post Office and military users. We also see a market among blind people". In total, he hopes to sell up to 100 systems a year in the U.K. Details 01-731 2077. □

Users' bid to buy Nascom fails as receiver accepts another offer

THE proposed take-over of Nascom by John Margetts, head of the Nascom microcomputer club has been abandoned now that the receivers, Cork and Gully, have accepted one

of the other bids for the company.

Although the bid has been accepted, Jack Haggart, temporarily running Nascom on behalf of the receiver, is not willing to disclose the name of the purchaser until a formal contract has been signed. This is said to be "imminent".

As reported in *Practical Computing* in August, John Margetts planned to form a company, financed by Nascom users and distributors, which could make its own bid for Nascom. Until very recently, he understood from the receiver that his bid would be given preference if he could raise the capital quickly enough.

According to Margetts he managed to raise only £10,000 in cash and several £100,000 in promises of support both from individuals and companies involved in Nascom add-ons and back-up.

Margetts claims that the

company turnover is now currently running at about £138,000 per month. The small number of staff at Nascom are being encouraged to stay on under the new ownership. □

No exit for Exidy

THE declaration by Exidy, reported in *Printout* in July, that it had sold the Sorcerer to Recortec seems to have been a little premature. Although the deal was planned, it never materialised and for the time being, the Sorcerer remains an Exidy product.

In the meantime, Sorcerer U.K. agent, Liveport of St Ives in Cornwall, has released a CP/M operating system and a Basic package for the Sorcerer, supplied on Micropolis discs. The package, with documentation, will cost £220 plus VAT. Details from Liveport (0736) 798157. □

Monitor EPROM produced for Ohio micros

A NEW monitor EPROM has been written for the Ohio Scientific microcomputers which use Microsoft Basic. Called CEGMON, it has been developed by George Chkiantz, Richard Elen and Tom Graves, the co-ordinators of the OSI U.K. user group.

It will be available in separate versions to suit the C1/Superboard II, the Challenger 2 and the new C4, reviewed last month, the enhanced, larger display, C1, and the UK101.

CEGMON is supplied

burned into a standard single-rail 2716 EPROM and can be installed with minor alterations to the processor board.

Some of the features of the new monitor include a screen editor, a revised keyboard routine, a completely new screen handler, NEWMON, a full machine-code monitor for the development of machine-code routines, input/output vectoring, and a floppy-disc bootstrap.

According to the authors, CEGMON retains all the major entry points of the

original SYNMON monitor and there is full compatibility with existing software, firmware and hardware at the fundamental level. Details from Dave Graham at Mutek on (0225) 743289. □

Z-80 operating system

INTERFACE Computer Services, the Essex-based consultancy, has been awarded the U.K. franchise for a new commercial operating system for Z-80 and Z-80A micros.

A Cobol compiler and an on-line debugging tool are provided as part of the system. Details: Witham(0376)518112. □

Graphics is growing reveals industry report

COMPUTER graphics is one of the most rapidly-growing areas of computing according to the latest Infotech state-of-the-art

report, Computer Graphics. In an invited paper in the report, Robert Dunn, of the U.S. firm Summagraphics, predicts that there will be a 100-fold growth in the use of computer graphics by the end of the 1990s.

The report examines many aspects of the field of computer graphics with particular emphasis on the use of interactive graphics. Among the topics covered are data management, hardware, computer animation, standards and applications.

The two-volume, 600-page report costs £150. □

MUSE to receive cash support for software-transfer project

THE Department of Education and Science, DES, has agreed to finance some of the work that MUSE, Microcomputer Users in Secondary Education, has planned for the next academic year.

The money, believed to be about £30,000 will be drawn from the DES advisory committee on microelectronics in schools, formed recently to promote the development of computer education.

One of the projects planned is a software-transfer service. MUSE hopes to appoint two research assistants, preferably school leavers, who can re-write education programs to make them compatible for all the microcomputers used in schools.

The chairman of MUSE, John Coll of Oundle School, has also been appointed as one of the five external members of the advisory committee. Mark Carlisle, Secretary of State for Education and Science, announced the formation of the committee shortly before the end of the last Parliamentary session.

The chairman will be A Halsey, Permanent Under-Secretary at the DES. G Hubbard of the Council for Educational Technology, J Major of the Department of Industry and J Mann of the Science Council have been appointed to the advisory com-

mittee as full-time assessors.

The five external advisors include only two teachers, A Clements of King Edwards Five Ways School in Birmingham and John Coll. The structure of the committee has already been criticised by the

National Union of Teachers, NUT, which has pointed out that none of the full-time members has any direct experience of computing in schools and that none of the external advisors teaches in the state sector. □

First British chess computer has recording facility and 13 levels

THE FIRST British chess computer, designed with the aid of David Levy, the well-known chess master and computer chess enthusiast, will be released by the Hertfordshire-based games firm Optim.

The chess computer now dubbed Intelligent Chess, has a built-in tape recorder which can record up to 1,000 chess games and replay them in colour on a domestic TV set. The game will be aimed at the

top end of the computer chess market and is expected to retail at about £295.

The game performs all the usual operation of any chess computer, playing an opponent at different levels of difficulty, playing against itself, suggesting the next best move to an opponent, but includes the additional features of the TV interface and the ability to record the games with a talk-over commentary.

The computer can also be asked after it has moved what its next best move would have been and the player can at any time step back moves, even to the start of the game.

The computer, with 13 levels of difficulty, is based on the 6502 chip, has 64K bits of ROM and 16K bits of RAM. Optim intends to release another, less sophisticated chess computer for £39.95. Details from Optim on (0279) 54547. □



THERE'S A WORLD OF DIFFERENCE In Business Software!

Get the most out of your microcomputer Graham-Dorian's Integrated, On-Line Programs Are Fast, Efficient, And Easy To Use.

At any given time, your hardware is only as useful as the software you run in it. Our programs let you realize the full potential of your hardware.

Graham-Dorian provides highly detailed and well documented programs. All pre-tested on the job. Each so comprehensive that it takes little time to learn to run a program — even for someone who's never operated a computer before.

Graham-Dorian programs are on-line now working for us and others around the world. They are ready to go to work immediately or to be tailored for your more specific needs. Each package contains a software program in BAS and INT file form plus a user's manual and hard copy SOURCE LISTING.

Programs are compatible with most major computers using CP/M disk operating systems, and come in standard 8" or on various mini-floppy disks.

Graham-Dorian stand behind dealers with technical advice.

Yes, there's a world of difference in business software. Graham-Dorian has more per-package capabilities and more packages (with new ones added every few months).

The Graham-Dorian line now includes these packages

- Nominal Ledger
- Purchase Ledger
- Sales Ledger
- Job Costing
- Order Entry & Invoicing
- Payroll
- Manufacturing Inventory
- Manufacturing Job Costing
- Wholesaler Inventory
- Retailer Inventory
- Cash Register
- Apartment
- Surveying
- Dental

CBASIC-2

Ask your dealer* for a demonstration soon.



Distributors for Micropro: — Wordstar, Datastar & Mailmerge, CP/M for Tandy Model I & II.

+ GDSS are appointing UK Dealers and European Distributors. Enquiries and applications invited.

* CBASIC-2 is a trade mark (copyright 1980) of Compiler Systems, Inc. GDSS are the European Distributor for CBASIC-2.

Graham-Dorian Software Systems
17 The Gallop, Yateley
Camberley, Surrey.
Tel: (0252) 874790 (0344) 51160.

ALTOS

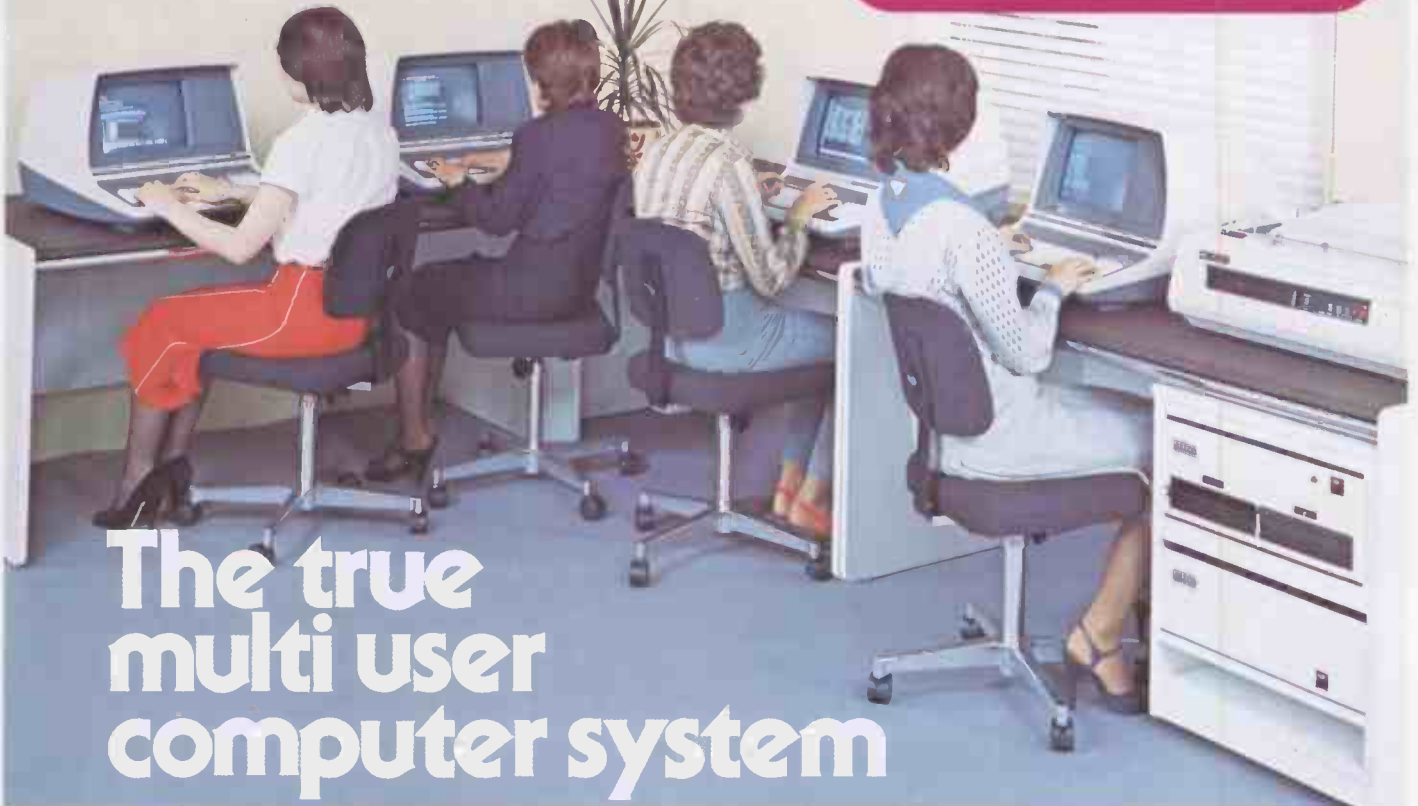

The true multi user computer system

The ALTOS ACS 8000 range of business/scientific micro computers creates a new standard in quality and reliability in high technology micro computers.

Hard Disk/Multi User Systems

The Winchester hard disk/multi user systems are now available supporting up to 4 simultaneous users and providing a maximum of 58 Megabytes of hard disk data storage.

The systems are truly flexible and allow expansion of the ALTOS floppy disk system to keep pace with the users requirements.

Still single board, features include

- a high speed I/O section with up to six serial ports and one 8 bit Parallel port
- up to 208K of on board R.A.M.
- High speed (4 MHz.) D.M.A. control as standard.

Yes, mini power and at micro cost too.

Hard Disk Security Back-up

The 17.5 Megabyte funnel tape unit permits selective dumping from the Winchester at a rate of 1 Megabyte per minute.

Built-in Reliability

The ACS 8000 range are true single board micro computers making them extremely reliable and maintainable. All electronics are socketed for quick replacement. Complete diagnostic utility software for drives and memory is provided.

The board and Shugart floppy disk drives are easily accessible and can be removed in less than ten minutes.

Quality Software

Unlimited versatility. The ACS 8000 range support the widely accepted CP/M and MP/M operating systems plus basic (Microsoft and CBasic), Cobol, Pascal, and Fortran IV. All available now.

Logitek in conjunction with its own micro software house, Interface Software Ltd. of Camberley are able to supply a wide range of proven 'off-the-shelf' business software including general accounting, word processing, stock control, mailing list etc.

There are already over 1000 micro computer installations using this software. A track record which we consider speaks for itself. Why 're-invent the wheel' when there is standard software of this quality available now?

Communication Software

Two new custom software packages are now available for the Altos Computer System operating with CP/M to enable it to communicate with remote machines over ordinary telephone lines. ASYNC is an asynchronous package that operates with almost any remote machine. SYNCH is a synchronous package for use with the IBM 3780 protocols.

Custom Graphics & Scientific Software

A full graphics and scientific package is now available for use for the Altos with FPP.

GRAFLIB is a custom Altos software package containing a complete range of FORTRAN-callable graphics subroutines. It is designed with DRE RG-512 board, or a Tektronix 4000 series graphics terminal. Several multi-colour X-Y plotters are supported allowing hard copy in addition to screen graphics.

After Sales Support

Logitek are supported by DDT Maintenance Ltd. who provide a nationwide field maintenance service for Altos products and offer the option of maintenance contracts.

Availability

Logitek carry deep shelf stocks of Altos hardware and compatible peripherals.



LOGITEK

LOGITEK, E.I.C. Electronics Ltd.

All enquiries to

8-10 Fazakerley St., Chorley,
Lancs. Tel: 02572 67615/70206

also at

30 Kelvin Ave.,
Hillington Industrial Estate,
Glasgow G52 4LH

Logitek are now the exclusive distributors of Altos Computer Products for the U.K. and Eire

• Circle No. 163



... DOWN TO BUSINESS
WITH MICROTREND
PROFESSIONAL SOFTWARE

● DATA PROCESSING ● WORD PROCESSING ● OFFICE AUTOMATION ● COMMUNICATIONS ●

FOR DETAILS CONTACT

Microtrend Ltd.,
P.O. Box 51, Pateley Bridge,
Harrogate.

Microtrend Int. BV.,
P.O. Box 71012, 1008 BA Amsterdam,
Holland.

Microtrend GmbH,
Post Fach 2815, 8500 Nürnberg,
West Germany.

53

• Circle No. 164

HARD. AND FAST.



Corvus/Constellation. A new concept in mass storage and shared data multiplexing for Apple, TRS-80, Pet, S100 and LSI-11.

Hard and fast. Corvus and Constellation. Together they offer a tremendously powerful mass storage solution to the problems of micro-computers.

The Corvus hard disc drive is far superior to floppies—your disc accessing speed will normally be about twenty times faster. And any problems of back-up transfer are eliminated by the unique Corvus Mirror system which allows you to dump onto a video tape recorder at 1Mb per minute.

If you have a microcomputer system you just plug in and go, like any of your other peripherals. All the interfaces have been designed and

tested to work with your existing software, so there is no new disc operating system to learn.

And Constellation is the way to turn your computer into a multi-user system. Ideal applications are word processing, stock control and education. Link together two to sixty four computers sharing up to 40Mb of Corvus capacity (four eight-inch Winchester disc drives), share the peripherals and communicate with other computers in the network.

You can implement a Corvus disc system as a simple single-user computer system and upgrade later to a multi-user network with no penalty in

cost or software effort. The computer interface hardware is the same as for the single-user disc system, while the operating system software is that provided with the host computer.

It's a powerful argument. Ask Keen to tell you more about it.

Keen Computers

5b the Poultry, Nottingham NG1 2HW.
tel: 0602 583254.
telex: 37297 (keenco)

28 Lower Addiscombe Road,
Croydon CR0 6AA. tel: 01-680 4646



• Circle No. 165

DESKTOP Plan is one of the first corporate-modelling packages available for micro-computers in the U.K. It was written in the U.S. by Don Williams and is marketed under the colours of Personal Software Inc — the vendors of VisiCalc — see *Practical Computing*, June.

Desktop Plan will run on either the Apple II Eurapple or the ITT 2020 with a variety of printer devices. A 32K machine with one or two disc drives will be required. The review copy was supplied by Keen Computers.

The system is structured so that three files are created through a series of interactive screen formats which, when combined subsequently, produce a numerical analysis and pre-formatted report.

The package is a modelling facility which may be user-programmed to produce any common type of business report and application areas including:

- Profit and loss accounts
- Balance sheet
- Cash flow
- Budgetary control

Desktop Plan need not be limited to business applications and can cope with personal finance, taxation analysis and many other applications. The criteria for using Desktop is essentially that the user wishes to computerise a tabular report.

Tabular reports with multiple columns of data which can represent timescale, products, etc., and be interlinked or separate are ideal for the package.

The main difference between VisiCalc and Desktop Plan is the Desktop sophist-

Corporate modelling with many uses by Desktop Plan

icated reporting facility. The level of report definition is so good that the business user is able to produce reports acceptable in a business environment

by Mike McDonald

which need not be typed or finished on a conventional typewriter.

On the other hand VisiCalc is better at complex calculations and numerical inter-relationships in array calculations. Desktop Plan is supplied on a single mini-floppy disc with a 144-page A5 binder.

The three files created by Desktop Plan are:

1. A report description/definition file.
2. A planning values or data file.
3. A calculation rules file.

Initially, the user defines the report format in terms of title, column headings, line descriptions and appropriate punctuation. Once created, the file may be used to produce a dummy report which serves as a planning document for the next two phases.

The data-file creation uses the report

definition to display each of the lines in the report model for data entry against each. Once a file has been completed, the calculation rules are entered defining the relationships between the data lines and columns.

That file is then executed with the input data file to produce a set of results which may be printed using the report definition and saved as another data file.

The multi-file structure used in Desktop Plan allows the user to create a variety of data files for running against a single model or vice versa. Data files, or result files, may be combined to produce a consolidated version for further processing or reporting.

The package and its functions are accessible through a master menu offering:

1. Enter or modify report description file.
2. Enter, modify or display values file.
3. Enter or modify calculation rules file.
4. Execute calculation rules.
5. Print reports.
6. Consolidate/summarise files.
7. Transfer file to another diskette.
8. Set system parameters.

We set-up a simple three-year plan for a fictitious small company. On selecting the report description option, the system prompts for up to three lines of title. Each line may be up to 30 characters long and each entry is spaced proportionately at print time.

Maximum limits

The user must next define the model size in terms of the number of lines and columns to be used. The entered values are the maximum limits the model can reach.

The stated maximum values for the package are 300 lines and 18 columns but due to the limitations of memory there is a practical maximum. Quoted examples are 255 lines by 18 columns on a 48K Apple and 100 lines by 13 columns on a 32K system.

The next request is for the column headings of which there may be two lines of nine characters for each position. A screen format offers the user an appropriate number of positions on the screen to enter each column heading and also requests a decimal indicator which will define globally for that column the number of decimal places to be printed.

As with most of the screen formats throughout the package, the user is given the opportunity of changing any erroneous entry before moving on to the next screen, or function.

Desktop Plan can only display the report-line descriptions in blocks of 10 on



| PRACTICAL COMPUTING DTP REVIEW ABC CO LTD - THREE YEAR PLAN | | 8 AUGUST 1980 PAGE 1 | | |
|--|--------------|-------------------------|--------------------|--------------------|
| STAGE 2 - REPORT & PLANNING VALUES | | BUDGET 1 YEAR 1 | BUDGET 2 YEAR 2 | BUDGET 3 YEAR 3 |
| SALES (UNITS) | (2) | 10000 | - | 45000 |
| SALES PRICE (PER UNIT) | (3) | 13.54 | 15.25 | 18.70 |
| REVENUE | (5) | - | - | - |
| COST OF SALES | | | | |
| MATERIALS | (9) | 47932 | 52000 | 65000 |
| PROCESSING | (10) | 17000 | - | - |
| MARKETING | (11) | 7500 | - | - |
| STAFF | (12) | 24580 | - | - |
| OFFICES & BUILDINGS | (13) | 12400 | 14000 | 17500 |
| TOTAL COSTS | (15) | - | - | - |
| GROSS MARGIN | (17) | - | - | - |
| GROSS MARGIN % OF REVENUE | (18) | - | - | - |
| TAX DUE (52%) | (21) | 1 | 1 | 1 |
| NET INCOME AFTER TAX | (24) | - | - | - |
| ===== | | | | |
| DIVISION FACTOR | -CONST- (27) | 3 | 3 | 3 |
| TAX RATE | -CONST- (28) | 52.00 | 52.00 | 52.00 |
| MULTIPLICATION FACTOR | -CONST- (29) | 100 | 100 | 100 |
| INFLATION RATE | -CONST- (30) | 18.00 | 16.00 | 19.00 |

PREPARED WITH DESKTOP/PLAN-COMPANY CONFIDENTIAL

Figure 1.

a screen and, therefore, uses a blocking system for that function. Depending on the number of lines declared earlier, Desktop will provide a number of sequentially number blocks automatically containing each group of lines also sequentially numbered from one up to the maximum, i.e., if 50 lines are input as the maximum, the package will produce five blocks numbered 0,1,2,3,4 and each block will contain lines 0 — 1 to 10, 1 — 11 to 20, 2 — 21 to 30, etc.

Each block is accessed by its number and line descriptions entered against whichever lines the user wishes. Each line description may be up to 30 characters long and for each line entered, the user must enter a decimal specification of either 0,1, or 2. That indicator will be used both at the data-entry stage and at the report stage unless overridden by the column specification.

Lines are accessed and entered by their number and users are advised to leave some intermediate blank lines for expansion or modification at a later stage. Once the limits are entered at the beginning of the report description, they may not be changed and the size of the report model is fixed.

Report definition

Each block is accessed in turn and line descriptions entered until the report definition is complete. There are a number of shorthand characters for producing:

- '=' Only entry for a double underscore under each column.
- '-' Only entry for a single underscore under each column.
- '#' Only entry for a blank line.
- ...' Only entry for a start-new-page heading.
- ^ Last character entry on a line description for that line to be used as a sub-heading.

We found those special characters very useful in producing a neat report format. On completion, Desktop Plan prompts the user for the name of the file under which the format will be stored.

| PRACTICAL COMPUTING DTP REVIEW ABC CO LTD - THREE YEAR PLAN | | 8 AUGUST 1980 PAGE 1 | | |
|--|--------------|-------------------------|--------------------|--------------------|
| STAGE 1 - LISTING OF REPORT FORMAT | | BUDGET 1 YEAR 1 | BUDGET 2 YEAR 2 | BUDGET 3 YEAR 3 |
| SALES (UNITS) | (2) | - | - | - |
| SALES PRICE (PER UNIT) | (3) | - | - | - |
| REVENUE | (5) | - | - | - |
| COST OF SALES | | | | |
| MATERIALS | (9) | - | - | - |
| PROCESSING | (10) | - | - | - |
| MARKETING | (11) | - | - | - |
| STAFF | (12) | - | - | - |
| OFFICES & BUILDINGS | (13) | - | - | - |
| TOTAL COSTS | (15) | - | - | - |
| GROSS MARGIN | (17) | - | - | - |
| GROSS MARGIN % OF REVENUE | (18) | - | - | - |
| TAX DUE (52%) | (21) | - | - | - |
| NET INCOME AFTER TAX | (24) | - | - | - |
| ===== | | | | |
| DIVISION FACTOR | -CONST- (27) | - | - | - |
| TAX RATE | -CONST- (28) | - | - | - |
| MULTIPLICATION FACTOR | -CONST- (29) | - | - | - |
| INFLATION RATE | -CONST- (30) | - | - | - |

PREPARED WITH DESKTOP/PLAN-COMPANY CONFIDENTIAL

Figure 2.

The file organisation in Desktop is sophisticated and very secure. Report, data, calculation, and results files may all have the same nominated name which is suffixed automatically by Desktop and accessed by virtue of the function being performed. In our case, all the files were called TESTRUN and a catalogue of the disc showed —

- TESTRUN.D — report description file
- TESTRUN.I — data input file
- TESTRUN.R — calculation rules file
- TESTRUN.C — computed results file

Throughout each stage the user is prompted only for the prefix name if accessing an existing file. That makes life much easier when entering the execution mode as only one file name must be entered.

Users may, of course, opt for different names, in which case Desktop Plan will

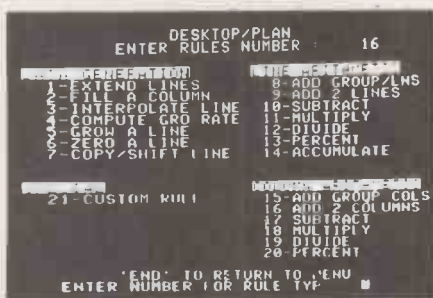

prompt for the name of each of the files involved.

Having produced the report definition, the manual suggests that a dummy report is produced to ensure that the format is correct and to act as a planning document for the balance of the exercise. When option five of the main menu is selected — Print Reports — the user enters the name of the report and results file for printing.

As no results or data files exist, none may be entered to produce a blank report. Each time the report option is used, the user is prompted from a sub-menu for the following options:

- Print line numbers Y/N? — These are useful in the planning stage and would be omitted on a final report.
- First line to print — In our case we stored lines of constants.
- Last line to print — constants at the end of the report format and suppressed the printing of these on the final report.
- Number of model columns per page — this defines how many columns are required across the page.
- Stop at the end of every page Y/N? — this allows the user to load or unload stationery during the course of running.
- Run description — this is a 30-character description used to identify each report produced.

We produced a dummy report from the description entered and this is shown in figure 1. On the printer used, we could only print three columns across the page out of our four-column model but that was not critical in the development stage.

Line descriptions

Desktop Plan uses fixed-length line descriptions and fixed-length columns and, therefore, can produce only x number of columns depending on the width of the printer used. The quoted limits are

| Printer width | Number of columns across |
|---------------|--------------------------|
| 156 | 12 |
| 132 | 9 |
| 80 | 4 |

These limits are unfortunate but the package has been programmed to split reports, printing the maximum number of columns on one page and the balance on a re-formatted new page. The results in this form are quite acceptable but awkward.

The manual recommends the user to enter at this stage the data to be used in the calculations. We were not convinced that this is the proper way to go about things but complied by accessing function two on the main menu — entry of planning values. (continued on next page)

(continued from previous page)

The user is prompted for the report-definition file name and each line is displayed for the user to enter values under each column number. The user is warned that some data-entry effort may be saved by using some of the data-handling functions available within the calculation facility such as:

- Extend/fill line
- Interpolate lines
- Grow a line
- Fill a column

A number of special key functions within the program ease the task of the data entry. The user can use the forward and backward cursors to duplicate entries across the fields or just move around.

Lines may be accessed by number or by the cursor which will step forward or backward sequentially to adjacent lines. Initially, the key functions can be confusing but with some practice, they should speed the tedious process considerably.

Data files are modified from the same program and a sub-menu offers enter values, modify values or display values. As data lines are accessed, these are displayed, three across, on the screen with the first line of the column header and the column number displayed in reverse above each.

Once the entry or modification has occurred, the values entered or changed are written to the file name prompted on selecting the function from the main menu.

Planning values

The user may optionally now produce a second report using the entered planning values. This step is recommended for the first-time user and we once again entered option five — print report. Figure 2 shows the report produced with the appropriate data values saved in TESTRUN.I. This report was used to determine the calculation rules necessary.

The calculation rules are the series of instructions for manipulating the data entered and producing the desired results. There are 20 standard rules available in three groups; data generation, line arithmetic and column arithmetic. Rules are selected from a sub-menu and are sequentially numbered automatically.

Figure 3.

| CALCULATION RULES NAMED TESTRUN.R | | 8 AUGUST 1980 | | | | |
|-----------------------------------|---------------------------------|---------------|--------|--------|-------|-----|
| NUMBER | DESCRIPTION | LINE 1 | LINE 2 | LINE 3 | COL 1 | 2 3 |
| 1 | 3-INTERPOLATE LINES | 2 | 2 | 0 | 1 | 3 0 |
| 2 | 11-MULTIPLY TWO LINES TOGETHER | 2 | 3 | 5 | 1 | 3 0 |
| 3 | 5-GROW A LINE | 10 | 30 | 0 | 1 | 3 0 |
| 4 | 1-EXTEND & FILL LINES | 11 | 11 | 0 | 1 | 3 0 |
| 5 | 5-GROW A LINE | 12 | 30 | 0 | 1 | 3 0 |
| 6 | 8-ADD A GROUP OF LINES | 9 | 13 | 15 | 1 | 3 0 |
| 7 | 10-SUBTRACT A LINE FROM ANOTHER | 15 | 5 | 17 | 1 | 3 0 |
| 8 | 11-MULTIPLY TWO LINES TOGETHER | 17 | 29 | 18 | 1 | 3 0 |
| 9 | 12-DIVIDE ONE LINE BY ANOTHER | 18 | 5 | 18 | 1 | 3 0 |
| 10 | 11-MULTIPLY TWO LINES TOGETHER | 17 | 28 | 21 | 1 | 3 0 |
| 11 | 12-DIVIDE ONE LINE BY ANOTHER | 21 | 29 | 21 | 1 | 3 0 |
| 12 | 10-SUBTRACT A LINE FROM ANOTHER | 21 | 17 | 24 | 1 | 3 0 |
| 13 | 15-ADD GROUP COLS/CROSSFOOT | 2 | 24 | 0 | 1 | 3 4 |
| 14 | 12-DIVIDE ONE LINE BY ANOTHER | 3 | 27 | 3 | 4 | 4 0 |
| 15 | 12-DIVIDE ONE LINE BY ANOTHER | 18 | 27 | 18 | 4 | 4 0 |

The numbering of the rules determines the order in which they will be executed and has no bearing on the line numbers of the report lines or data lines. It is very important to have the correct sequence of calculations otherwise erroneous results will occur.

We found that it was important to write our set of rules on the dummy reports before entering them as they cannot be

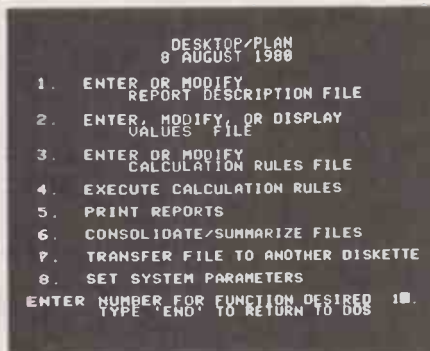

reviewed in the course of entry except by exiting the entry phase.

Each calculation rule has its own screen format and the rules are invariably defined as a function of:

- Operator line
- Operand line
- Results line
- Start column
- Finish column or results column

Once a calculation rules file has been created, the rules may be listed on the printer for verification or editing. The user is offered the rules sub-menu, enters the option and the line or column criteria and is then returned to the rules sub-menu for the next rule input.

The rule options are:

- Data Generation**
 - 1. Extend columns
 - 2. Fill a column
 - 3. Interpolate a line
 - 4. Compute growth rate
 - 5. Grow a line
 - 6. Zero a line
 - 7. Copy/shift a line
- Line Arithmetic**
 - 8. Add group lines
 - 9. Add two lines
 - 10. Subtract
 - 11. Multiply
 - 12. Divide
 - 13. Percent
 - 14. Accumulate
- Column Arithmetic**

- 15. Add group columns
- 16. Add two columns
- 17. Subtract
- 18. Multiply
- 19. Divide
- 20. Percent
- Special rules 21.

Most of the calculation rules are self-explanatory, i.e., add, subtract, multiply and divide, between columns of lines and will not be examined in any depth. The key attribute of most of those operations is that the results may be placed in any line or column position in the model.

Complex calculations

That means substitution can occur and complex calculations performed within a small model. The warning to users who expect to use the feature is that it makes debugging an exceedingly difficult task. Some of the less usual functions in more detail are:

1. Extend/fill lines: This will duplicate a value from a column position to all following blank column positions. If a new value is encountered further up the line, this value will be extended from that point on, etc., i.e., line 1 = 23 --- 45 --- becomes 23 23 23 45 45 45.

4. Compute a growth rate: Rule four will calculate a single-figure growth percentage for a given line and place it in column one of a nominated results line.

5. Grow a line: This will compute compound growth on a selected line using another line containing a percentage in each column position.

7. Copy/shift right: Will copy a line to another line position and optionally shift the values x positions to the right. Useful for carried-forward calculations.

13. Percent/line of a value: Rule 13 calculates the percentage value of each value in a line in relation to a single value in another line.

20. Percent/column of a value: As for rule 13 but performs the function on a column of data.

Finally rule 21 is shown as special rules. Desktop Plan gives the user the option of specifying his own calculation subroutines written in Basic. Space has been left in the calculation program for a series of subroutines and the manual describes the array name in which the data table is held.

Documentation on that point is not detailed and such an exercise should only be attempted by a qualified dealer or a very experienced programmer.

Once the rules have been entered, they are saved in a file of the user's choice. Full files may be altered subsequently via the calculation rules sub-menu which offers;

- 1. Enter rules
- 2. Insert additional rule
- 3. Delete an existing rule
- 4. Display and or change a rule
- 5. Print the rules
- 6. Save the rules file

Option five is highly useful as we found it very difficult to debug the rules file on a display and change basis only. Figure 3 shows a listing of the rules as entered for our three-year plan.

The three lines and columns contain the appropriate reference for each operation and the manual must be consulted for an exact definition, but it generally follows the format quoted.

Having created the three files, TEST-RUN.D, TESTRUN.I, and TESTRUN.R, the system is now ready to execute the set and produce the required results. The execute facility on the main menu allows the user to enter a single file, prefix, name or different file names for the three inputs report, data and rules file names.

Each file is read in turn and the screen displays the current rule being executed as processing occurs. If an error is found, the system stops and debugging begins. If a clean run is achieved, the user is given the options of displaying the results on the screen — line by line, printing a report and saving the results file.

We proceeded to produce the final report shown in figure 4 having examined the key lines first with the display results option. Execution by Desktop Plan is quick and a quoted speed of 30 seconds is given for a model containing 168 additions, 18 subtractions, 48 multiplications, 18 divisions and 85 data moves.

The speed of execution is offset by the extensive disc file I/O which occurs. The program files are all separate in the disc and as each function is selected from the main menu, the program module is loaded followed by each nominated report, data or rules file.

The time lag becomes noticeable but the authors have been thoughtful enough to flash a series of messages informing the user of the current activity such as loading program or loading file type.

Having produced a report, the user is given the option of producing a second copy or re-defining the same report in terms of the number of lines or columns.

Consolidate facility

Once a model has been developed, a variety of data files may be input and run against the model. The stored data files constituting results may then be consolidated by selecting the sixth option on the main menu.

The consolidate facility may be used in one of two ways — macro consolidation of files that have the same line numbers and definitions and sizes and transfer specific lines from one data file to a consolidation work area.

Consolidated results may in turn be saved as a data file and called for further running against other models or report definitions. That facility is very useful, particularly in view of the limits of the model sizes but can be somewhat unwieldy to use.

It is suggested in the documentation that the user take advantage of Apple DOS execution files for running standard consolidations in a production running system — a recommendation we emphatically endorse.

| PRACTICAL COMPUTING DTP REVIEW ABC CO LTD - THREE YEAR PLAN | | 8 AUGUST 1980 PAGE 1 | | | |
|--|--|-------------------------|----------|----------|----------|
| STAGE 3 - CALCULATIONS AND REPORT | | BUDGET £ | BUDGET £ | BUDGET £ | BUDGET £ |
| | | YEAR 1 | YEAR 2 | YEAR 3 | TOTAL |
| SALES (UNITS) | | 10000 | 27500 | 45000 | 82500 |
| SALES PRICE (PER UNIT) | | 13.54 | 15.25 | 16.00 | 15.82 |
| REVENUE | | 135400 | 419375 | 641500 | 1396275 |
| COST OF SALES | | | | | |
| MATERIALS | | 47932 | 52000 | 65000 | 164932 |
| PROCESSING | | 17000 | 19720 | 23400 | 60187 |
| MARKETING | | 7500 | 7500 | 7500 | 22500 |
| STAFF | | 24580 | 28513 | 33330 | 87023 |
| OFFICES & BUILDINGS | | 12400 | 14000 | 17500 | 43900 |
| TOTAL COSTS | | 109412 | 121733 | 147397 | 378542 |
| GROSS MARGIN | | 25988 | 297642 | 694003 | 1017733 |
| GROSS MARGIN % OF REVENUE | | 19 | 71 | 82 | 58 |
| TAX DUE (52%) | | 13514 | 154774 | 360000 | 529221 |
| NET INCOME AFTER TAX | | 12474 | 142868 | 333160 | 488512 |

PREPARED WITH DESKTOP/PLAN—COMPANY CONFIDENTIAL

Figure 4.

Function seven of the master menu is a utility for file transfer between drives. It is needed given that Desktop Plan is provided as a suite of programs which are called from the various programs and, therefore, must always be resident on one of the disc drives.

There is not a great deal of space left on the master diskette for the files created by Desktop and thus both drives will be more than likely used in the course of normal running.

Function eight is a facility for altering the following parameters that are stored in a file within the master disc. They are:

- Printer Interface type
 - high-speed serial interface
 - communications interface, auto lf
 - communications interface, no auto lf
 - parallel interface
- File source drive
 - indicates to Desktop Plan where the files will be stored and saved.
- Set date function — this sets the system date which is printed-out on the top of each report automatically.
- Printer width — this sets the page width and is used by DTP to determine whether a requested number of columns can be on a report. If at the report stage the user selects more columns than the width can support then a message is flashed and the entry is disallowed.
- Page Length — this parameter is used by the package at the report stage to page skip automatically and re-print headings.

Overall, the system appears to be highly applicable in the business planning requirements of smaller companies. As a software program, it is well written and user-friendly with plenty of error-handling routines. The first-time user is safeguarded on this front.

The package has its limitations with regard to disc space and model sizes. The standard of the documentation with respect to the rest of the package is disappointing. The packaging is neat and of high quality. The text and structure of the manual is of poor quality.

We had a great deal of difficulty grasping the concepts of the package in the first instance and applying the information provided.

The 144-page manual is too padded-out with sales talk and copyright pleas. The relevant information is unfortunately fragmented around the pages and hard to find. Personal Software will do well to revise the format, soon.

Once we obtained a feel for the system, we found Desktop Plan easy to use for setting-up the simple model used in the article. Setting-up was easy; debugging was not.

Although facilities exist to help the user in debugging models, some improvement could be made, say, a trace facility with display of calculated lines at execution time.

Conclusions

- Desktop Plan is useful provided its limitations in terms of model size and columns per page can be accepted.
- The user-written calculation facility is good planning on the part of the authors and prospective buyers should discuss what help may be available from their local dealer.
- The standard of programming is high in terms of user-friendliness and disc I/O error handling.
- Execution of calculations is fast, but there is a large measure of time-consuming disc I/O.
- The automatic formatting of reports and page skipping is impressive and will save users significant time in development.
- Data-independence is a feature which appealed to the reviewer and means that multi-division companies can process individual results.
- Limiting factors for the application of Desktop Plan will be model size and the disc storage capacity, or vice versa depending upon the application area and design.
- The documentation is poor and illogical.
- Desktop Plan costs £95 but there is an impending price increase. □

Word-processing versatility with intelligent System B

THE Vector Graphic MZ System B hardware is supplied as a solidly-constructed cream-and-black box with a simple front panel consisting of an illuminated re-set button, a key-operated power-up switch, and a pair of vertically-mounted 5.25in. Micropolis quad-density disc drives.

A 4ft. cable — signals and power — runs from the computer to a mindless terminal which combines a white, rock-steady VDU with a customised pseudo-Selectric keyboard and numeric pad.

Robust main unit

Thick contoured fibreglass encases the metal chassis of the terminal, styled to match the robust, somewhat utilitarian appearance of the main unit.

A 2K ROM holds a monitor which, though far from perfect in its revision 4.0 form, certainly is a great help, though usually it need be applied only to such routine matters as memory tests and booting-up the DOS. The same ROM also holds a good VDU driver, used extensively by Vector Graphic software.

The mysteries of hardware and software are discussed in three comprehensive manuals: Hardware; Vector Graphic systems using MDOS; and Operating system utilities software/CP/M on Vector Graphic systems.

The engineering standard is solid. The units run cool and are strong enough to withstand the kind of treatment gen-

erally meted out to, say, expensive typewriters.

Options include various Qume and non-daisywheel printers; compiler for MBasic-80 and Word Management System.

As far as the ergonomics of the system is concerned, our feelings are mixed. The

**by Chris Bidmead and
Andrew Stephenson**

side and rear clearance in a typical lay-out are needed for ventilation which is provided by an acceptably-quiet fan. Thick documents can be laid on top of the computer without causing noticeable temperature rise — good for those who like to fit and forget and treat their machine as a table.

Access for maintenance is easy — the top lifts off after four side screws have been removed. That is also true of the terminal which gives the impression of having a tidy and uncluttered interior — an effect spoiled slightly by the rear connector cut-outs which, if equipped with more than the OEM minimum of cables, would become congested and effectively prevent the use of the rear-most two motherboard sockets. There are 18 sockets — an unusually large number for a modern machine — so that is hardly a problem.

The terminal struck us as a sad example of a lost opportunity. The Keytronic series of keyboards includes several which re-

semble the IBM U.S. 101 Selectric lay-out and which offer a choice of arrangements and codings of side keys.

The model L1660, a unit with 16 extra keys on the right and four, including Control, on the left, generates seven ASCII control codes and 46 non-ASCII codes, besides the control codes available in the normal way.

Vector Graphic, however, has discarded that flexibility by fitting a unit, identical but for a caps-lock key, whose side keys are coded principally as ASCII numbers, with a muddle of other codes which have to be interpreted by the system monitor.

Screen angle

It seems a pointless downgrading of a terminal which otherwise could have been instantly applicable to specialised systems with labelled side keys.

Another shortcoming is the angle of the screen. As mounted, it seems designed for a user who has set the keyboard almost at chest height. Furthermore, it is white, P4 phosphor or similar, and highly reflective — an awkward combination. Matters are not helped by the contrast control being situated at the rear of the case.

It seems a pity that a lack of tar should be allowed to spoil the ship — even as it stands, the terminal is very usable, the steadiness of the display, in particular, was appreciated.



The handbooks are, in the main, helpful. CP/M documentation is little more than re-prints of the standard Digital Research fare. In the sections contributed by Vector Graphic, clarity improved considerably. The general level assumes some familiarity with the system, which may delay the user at first but should please him later, once he has passed the beginner stage.

The result of all that is that experienced operators, or engineers, will find the system very easy to use. It is possible to switch on, press the correct button, and be inside a program, within seconds — virtually turn-key operation.

The system software is a mixture — a combination of products from independent sources. The historical background of the Vector Graphic range is also a factor in the software's mixed character.

Unfortunately, knowing that does nothing to help the user, who must master at least several sets of commands and procedures if he is to make the most of CP/M and MDOS, both of which are supplied, and both of which must be learned for the sake of the programs which run under them.

For example, the directory command in MDOS is "FILES", in CP/M it is "DIR", in Vector Graphic DOS, MZOS — not advertised but present as part of Word management — needs "FI", while Word management itself views the directory with the somewhat unfortunate abbreviation, "VD".

Subsidiary programs, too, demand their own learning periods; Basic-80 uses different commands to achieve the same results as CP/M, its DOS.

MDOS documentation

MDOS is splendidly documented, and seems capable of coping with just about every aspect of disc-file manipulation. Its weakness is that, like North Star DOS and others, it resides at the bottom of RAM, and so requires all user programs to start above it.

Thus, any expansion of the DOS will encroach on the program space, unless headroom is left, which is neither a guarantee of safety, nor particularly economical in RAM.

By contrast, CP/M resides at the top of RAM and so allows all user programs to start at a fixed low address, 100 Hex. CP/M or programs running under it may expand into the intervening space, which may be enlarged, if necessary, by adding RAM and causing CP/M to re-locate itself upwards — no changes need then be made to user programs.

There exists a problem more general than one of simple inconsistency. It amounts to the feeling that System B may not be a complete system, that it still needs a rationalisation exercise to smooth away its rough edges and fit it to the turn-key users at whom it appears to be aimed.

One curiosity which exemplifies this is that virtually all the software docu-

mentation uses extended-8080 mnemonics, rather than those designed officially for the Z-80 by Zilog and Mostek.

Again, it can be blamed on history and, perhaps, on the fact that CP/M is 8080-orientated. Maybe Digital Research should issue its own CP/M Zilog/Mostek Z-80 assembler, to give history a helping hand.

If we seem too funereal, it is worth re-emphasising that System B is a very useful collection of hard and software as it stands. Anyone who settled on CP/M alone could manage splendidly. There are clear signs that Vector Graphic is working on transferring all its software to CP/M, although some major items still depend on the comparatively primitive MDOS, or

Hardware

Z-80A, i.e., 4MHz, CPU
64K dynamic RAM, normally reduced to 56K
Two Micropolis 5.25in. drives, 630K totals, mounted vertically
Flashwriter II memory-mapped VDU, 80 characters x 24 lines
12K PROM board with burner for 2708/2704
Three serial I/O, two parallel I/O ports, cable for only one S-10, others extra

even — such as Word management and Mail merge — on MZOS.

As evidence of the considerable development effort Vector Graphics appears to have invested, consider the extra CP/M programs supplied:

Back-up makes copies of whole discs on to unformatted discs, removing any need to initialise them first.

Raid — RApid Interactive Debugger — is an amazing re-locatable 6K simulator of Z-80 programs — extended 8080 mnemonics. It shows, in screen sub-divisions, such information as the segment of program being simulated with disassembled code, register contents, flags and stack contents.

Separate segments of display are reserved for program output, memory dumps in ASCII or Hex, halt information, and details of which program area is to have its simulation displayed.

Scope — SScreen Orientated Program Editor — is intended to replace the CP/M ED program. It is a versatile on-screen line editor of CP/M ASCII files representing documents up to 250 columns width, which are viewed through a window formed by the screen. Four modes — command, change, insert and control — are used.

File-handling methods resemble those of ED but the facilities are considerably improved. However, the user is still limited to forward passage of text through the working buffer. A paginated print function — selective or global — is included. Total memory usage, combined with CP/M2 itself, is about 15K, the remainder is available for the text buffer.

ZSM is a disc-to-disc assembler of extended-8080 mnemonics which seems equal to most routine jobs. It also handles the CP/M USERCUST BIOS re-configuration function. Labels may be up to 47 characters, and of any number.

Assembly-time arithmetic is strictly left-to-right — no rules of precedence, or brackets. Conditional assembly is supported, as is assembly-time I/O of label values, a potentially useful feature.

CONFIG is a treat to use. It rapidly configures a CP/M disc to select the various automatic load-and-run options of CP/M2, for virtual turn-key operation, as well as assisting in setting-up printer software.

One important consideration for the end-user is the flexibility of the system. Here, again, we have to report mixed feelings.

CONFIG is certainly of great help — a disc can be configured with its aid to boot-up into a desired program, under the control of a non-technical user, e.g., a secretary, which frees the specialists for more productive work.

On the ergonomic debit side, the keyboard-dedicated side-keys mean that, in-text processors at least, commands will always have to be entered either as printable characters in a command code, or as control keys commands. That reduces efficiency and slows the learning process and these days, time is money in most places where this system is likely to be installed.

Character set

Software could have converted the keys to a numeric pad, if desired; it is always easier to throw away information than it is to obtain it.

One very pleasant feature which offers great scope for specials is the adaptability of the VDU character set. On the Flashwriter II, every character is defined by two PROMs which may be re-programmed as any dot pattern eight across by 10 high. The ability to invert video levels and/or, by hardware modification, reduce intensity or, with suitable PROMs, handle up to 256 characters, makes it very versatile. The flicker-free, screen-loading electronics permit highly-mobile displays.

Character re-programming could well be done with the aid of the PROM board, on which one socket of the eight can function as a programmer of 2708 or 2704 PROMs. The capacity of the board is normally kept to 8K or less, but can accommodate up to 12K of 2708 or 2704, plus 1K of RAM, thereby allowing the user to install his own resident utilities. We felt the choice of PROMs betrays the age of the board, but the 2708 is by no means obsolete.

The standard I/O configuration is a single cable from one of the serial RS-232 ports, intended to drive a printer and, therefore, connected as a data source. Extra cables may be purchased for plugging into the other serial or parallel ports.

The total selection is three serial 110-9600-baud RS232, with various bit-count and parity options, based on the Intel 8251, one having a 20mA loop option;

(continued on next page)

(continued from previous page)

and two eight-bit TTL parallel ports. The serial receives can generate independent vectored interrupts by polling, although use of the facility disables one of the parallel output ports. More I/O boards can be installed easily.

Of interest to multi-user purchasers is the fact that the System B can be fitted with more than one VDU board and terminal — up to five sets — and appropriate software which can presumably be combined with the CP/M2 multiple-user file handling, although individual user RAM is then limited to 48K.

Re-jumping makes memory allocation flexible, but essentially the lower and largest area is given to RAM, while the top of the memory space is occupied by VDU, 2K, monitor, 2K, and sundries such as the disc controller.

In practice, 56K of RAM is usually available to the user, though bank-switching allows eight banks of up to 56K each. The manuals describe in some detail how to adjust addresses and other optional function settings, though we guess that some heavy homework would be involved in software-patching the operating system to make the most of the formidable potential of 448K.

Technical information

The technical information provided to system developers is exhaustive, even extending to cover the proper procedures for writing DOS, if desired. Description of the mechanics of the drives is sketchy.

The Micropolis disc drives run continuously once discs have been mounted, so we were not surprised to find that the handbook rates the life of a disc at possibly as little as 2,000 hours — an estimate that takes no account of wear due to head contact.

Comparatively cheap though discs are, there must be an insidious cost implied in the extra work of monitoring their life and the risk of a fault developing unnoticed during idling time.

Micropolis claims that the discs are not damaged by continuous running but Vector Graphic suggests that the drives be switched off-line when unused for any length of time. However, if you are making a regular habit of unlatching discs during sessions, from time to time you will inevitably try to write to a drive that is not up.

That is especially easy to do as the disc-unit exterior design makes it difficult to see if discs are on or off. Our solution was to put coloured stickers on the door latches, so that when the outer, green-labelled latch slides to one side, it reveals the red patch underneath, indicating even at a distance that the drive is engaged. If you try to write to a drive which is not up, the drive button lights, the empty hub spins for a while, and CP/M returns the somewhat misleading news that it has encountered a "BAD SECTOR".

The error causes CP/M to unlog the

loaded disc, so that subsequent attempts to save the program in core memory are frustrated by the CP/M otherwise helpful habit of marking temporarily an unlogged disc as read only. It is relatively easy to re-log with a warm boot — Control C — but if you were in Basic, you will find you are back at DOS level.

That need not be fatal if you happen to know that CP/M keeps its current COM file at start address 0100. It is a simple matter to jump back into Basic and restore the current program. Those who do not know that — and mention of it is made in the CP/M manual — could finish by losing a program or two.

The file handling employed by the Word management system (WMS) does not create this problem. Even with the drive off, it still knows the name of a document being revised. It will tell you if a drive is off-line, and the UD command will create an update under that name once you have powered-up the drive.

Once booted-up with the Word management system, a process that takes

Summary specifications

CPU — 6502.
Memory — 32Kbytes RAM, Basic operating system in ROM.
Keyboard — 73 keys with cursor control keys and separate numeric keypad.
Screen — 12in. diagonal, green phosphor, displaying 24 lines of 80 columns.
Character set — upper- and lower-case alpha-numerics, but not with normal ASCII values, plus about 100 graphics characters.
Discs — Recording on mini 5¼in. floppy discs in two drives to 170Kbytes per drive (2040) DOS 2.1 and with own intelligence.

less than a minute, the System B appears to the user as a relatively simple and comprehensive word processor, differing from the dedicated system in that all the control processes — except cursor movement — have to be accessed through two keys — control and a letter.

Though this does not represent any long-term problem to the user who is prepared to familiarise himself with the lay-out, the complication of having to know the control code keys might add to the technophobia of, say, the temporary secretary. No help prompts are available, and the well-laid-out Vector Graphic manual needs to be kept at hand.

The design philosophy differs from some rival system in that WMS retains a complete copy of the working document in RAM. One immediate advantage is that global searching becomes very fast — a valuable asset if only because it quickly becomes the technique for finding one's way round long texts. A price is paid in the theoretical vulnerability of the work in progress to mains-born problems. Theoretical, because during extensive use, no trouble of that kind was experienced.

The simple and fast updating instruction, UD, is always available to put revisions safely back on to disc, and its regular use is recommended.

Whether being able to choose one's own breaks like this was preferable to disc-based systems like WordStar, where the writer is interrupted in mid-flow by automatic disc updates is open to question. Because the whole document is written back to disc each time, disc-waits become relatively lengthy as file capacity — about 24 A4 pages — is reached. When timed, it is extraordinary how long a mere 15 seconds can seem in comparison with the speed of the system as a whole.

Running back-up copies on to a disc on the other drive is almost as easy as a simple update, although the disc copied to must not already contain the named file. That introduces a slight complication in the event of making a second back-up copy, but it remains the simplest disc-copying procedure we know.

The directory presents files as a row of five columns, and access is by using the cursor keys to move an inverse video block. Single letter commands are typed once the block is located correctly over the file name, and appear beside it as a visual check before you hit return. Thus the title of a file need be typed only once, when the file is created.

That protocol allows reading (R), saving (S), protecting (P), unprotecting (U) and appending (A) of the addressed file. In practice, the approach makes for fast and easy working as long as the number of files on each disc is limited to about 20. With more than that, unnecessary time is wasted looking for the position of the file name in the catalogue and positioning the cursor.

There is another good reason for minimising the number of files on each disc; space allocation is not dynamic under the MZDOSE operating system, and the creation of a large number of small files tends to use a good deal of tracks, even if those files are deleted subsequently. There is a compacting procedure to redress this, but the process takes as much as six minutes.

Scrolling mode

Documents created on screen can be read either by paging or scrolling, and both modes permit movement in either direction with the space bar used as a start/stop toggle. Scrolling produces the usual somewhat giddy effect, particularly as its speed is uncontrollable.

Paging is more restful to the eye, and would be ideal but for the fact that the page mode announces itself via a small flashing square in the bottom-right-hand corner which obscures two letters of the text.

The scrolling flag appears in a similar position, but in that mode, it is, of course, possible to move up the page slowly to read what lies underneath. That is a niggling point which is easily forgiven.

The Global Search facility the WMS system offers is certainly very useful, but lacks two important options: upper- or lower-case must be defined in the search



string — there is no facility for ignoring case; and if a replace string is defined, there is no pause each time the required phase occurs to choose whether to make the switch or not.

One can choose the number of times the switch is made, starting from the cursor position, but that seldom is the requirement in real life.

Usually, the cursor rests at the beginning of the searched string, not at the end as in some systems. The search facility also permits wild-card characters represented by the hash sign.

That is useful for checking suspected spelling errors, but also in the absence of an ignore-case option, it should be valuable for testing for words at the beginning of sentences.

There seems to be one small bug in this facility on the System B — searching for a string beginning with a hash sign does not end when the search reaches the end of text; the program then begins to loop as the whole of system memory is searched for a string beginning with any character.

Word-wrap facility

The loop may halt eventually, but we did not have the patience to wait more than five minutes and had to resort to the re-set button. It was not a major disaster, as the Version 4MZ monitor makes recovery from the re-set condition very simple.

In common with other word-processing systems, there is no need to carriage-return at the end of the screen — the last word is carried to the beginning of the next line automatically. It is a pity that this facility cannot be switched off, because we noticed that under some conditions the word-wrap becomes somewhat confusing, if not actually confused.

Two alternative cursors are available, one for normal typing — the overwrite cursor — and another for editing — the insert cursor. The problem occurs when text insertion with the very useful insert cursor chases material ahead of itself into the word-wrap area.

Sometimes characters which should be behind the cursor on the new line appear to vanish from the screen, only to reappear mysteriously in front of the cursor when the backspace key is used.

Inability to switch off the word-wrap facility also means that lines ruled across the screen collapse when they get into the word-wrap area, because the system takes them to be very long words.

A completely comprehensive word-processing system should be able to cope with hyphenation at the end of lines, but the designers of the Word management system have chosen to avoid the problem.

With word-wrap operating, the user will ignore line-end hyphenation — advisable unless he is prepared to risk tangling the printer formatting — but on print-out he will have to learn to live with rather more ragged right-hand edges than usual, or, if he chooses to justify text, some strange spacing if his lines lengths are short. Perhaps for this reason, the print format rules do not permit the printing of lines shorter than 25 characters.

Cursor movement is by character only and not by word, so that in comparison with the speed of the rest of the system, positioning the cursor sometimes seems subjectively rather slow, taking as much as 10 seconds to travel across the screen.

Control commands are used for toggling the cursor from insert to direct mode, for deleting whole lines or part lines, and for opening up blank lines for insertion. Dedicated keys control the cursor movement in four directions, and in the absence of a cursor-home key, the Control B command does double duty, returning the cursor to the top-left corner at the first issue of the command, and to the top of the whole text when the command is repeated. Control E works in the same way to take the cursor to the end of screen and end of text.

One very useful and unusual command enables deletion from the current cursor positioning up to and including any defined following character.

Thus Control R followed by a space deletes to the next space, i.e., deletes the following word, followed by a comma deletes the following phrase, by a full stop erases the rest of the line, and by a carriage return erases to the end of the paragraph.

In comparison with other systems, the marking arrangements for the duplication or removal of blocks of text seemed rather elementary. No highlighting defines the block once marked, and the prompt

“BLOCK MARKER ERROR” appears if there are more or less than two markers in play when block moving or copying is attempted.

It might be better design to make the introduction of the third marker remove the first one, so that there were never more than two. A recent addition to the software allows for the removal of those markers without having to go in search of them — but idiotically the process takes one back to the top of the text each time, so a search is still necessary for your original place in the text.

One limitation which we regarded as a major disadvantage, particularly in the printing of long documents, was the inability of the system to determine before printing where the page breaks are to occur. The problem is frankly summed up by Vector Graphic in the WMS Manual.

Conclusions

- Vector Graphic System B is a versatile and comprehensive word-processing system, well-suited to the generation of short documents.
- Sensible safeguards against accidental erasure of files have been built in, and the creation of back-up copies is easy.
- At about £300, the software alone — with the special character PROM — seems somewhat expensive.
- Sold as a combined software-hardware package, the system is highly competitive with dedicated word processors, and has the added advantage of offering the facilities of a microcomputer.
- Judged as a whole, System B seems good value for money at around £3,000.
- The phased evolution from 8080 to Z-80 philosophy is making the system software and documentation look somewhat jumbled.
- Yet that does indicate that the manufacturer is sensibly pacing itself, and seems to be taking the trouble to carry old customers forward with it.
- The Vector Graphic marketing support in the U.K. seems solid, with the possibility of further consolidation.
- Warranty is generous enough, 90 days from Vector Graphic; Almarc Data Systems, the sole U.K. distributor of Vector Graphic equipment and which supplied the review system, has recently introduced one-year cover.



SuperPet

THE Commodore Business Machines Pet computer is claimed to be the best-selling microcomputer in the U.K. The Pet was designed originally as a general-purpose small computer aimed particularly at the personal and hobbyist markets.

The personal computer market has evolved gradually so that, in the U.K. at least, most of the micros sold are purported to be for small business usage. That trend obviously changed the marketing directions of Commodore.

The trend to business usage has prompted the popular microcomputer manufacturers to announce business computers. Examples of that are the Apple III, the Tandy TRS-80 Mark II and, the subject of this review, the Commodore Business Computer 8032, nicknamed the SuperPet.

All those machines appear to be more business-like in having full-sized 12in. diagonal VDU screens capable of displaying 80 characters by 24 lines — a feature useful for word processing available on the majority of ordinary VDUs.

Is the CBM 8032 a business computer or is it merely the original Pet with a full-

by Vincent Tseng

sized screen and a few modifications to appear more business-like?

The new CBM 8032 SuperPet looks like the large keyboard version of the Pet with a larger screen. That is an all-in-one terminal computer, consisting of a 12in. diagonal screen, with a 73-key keyboard

in the QWERTY lay-out including a separate numeric keypad housed in a egg-shell-coloured casing of pressed sheet metal. On the back, there is an on/off switch and three cut-outs in the casing which expose three edge connectors.

As a ready-built system, to set-up, one attaches a mains plug, connects it to a mains outlet and switches on. The 8032 then emits a chirp from the built-in bleeper, and as it warms-up, the screen announces the Commodore Basic version.

The character lines of the display were not horizontal and inclined upwards to the left. As the inclined display did not prevent me from using the machine, it seemed a minor fault. Other than that, the display was of good definition and stability in green phosphor.

The machine, when booted-up, is in Basic.

****Commodore basic 4.0**** 31743 bytes free is announced in lower-case alphabetic. Typing on the keyboard produces lower-case alphabetic which the Basic recognises. Surprisingly, the Basic will not recognise upper-case characters inputted using either the shift or the lockable shift-lock keys.

Upper-case letters

The response of syntax error is given if upper-case letters are tried, which can be a little disconcerting if one is used to Basics which recognise only upper-case — the more common situation. However, that is a small point as a POKE command can be used so that the screen will display in upper-case acceptable to Basic.

Although the keyboard is reasonable to use and one can type relatively quickly on it, one minor point I found annoying was that it was noisy. Not the keyboard by itself, but in combination with the metal casing, it tended to produce a clanking sound with every keystroke.

That may be a consideration if the keyboard is to be used extensively e.g., in word processing, one would have to ensure that the user or typist will be happy with the feel and sound of the keyboard.

Among the keys available are some special-function keys. The more significant ones are cursor-control keys, down/up on one key, with up in the shifted position, right/left — “left” is shifted — and cursor-home sharing the same key as clear-screen.

There is a key to put the screen into reverse video and the shifted position turns it off. There is the usual delete key, but in the shifted position, this key allows insertion. A key marked stop acts as a break key, which in the shifted position is Run which loads the first program from drive 0 of the floppy discs, if installed, and executes it.

Due to the established customer base in Pets, it was not surprising to find that the version of Basic was very similar to the Basic on the older version Pet. Timings from the familiar benchmarks show that they were effectively the same as for the

older Pet — well within margins of error. However, there were additional commands for disc operation DSAVE, DLOAD, DIRECTORY. The SAVE, LOAD commands from Basic version 2.0, i.e., from the Pet, are upward-compatible with the 8000 series.

However, there was one feature I liked, not really part of Basic, but associated more with the operating system — the screen editing facility. Like the Nas-Sys supplied with the Nascom, it is possible to edit anything on the screen using the cursor control keys mentioned. The edited command or statement became effective after entering it by using the return key at the end of the edited line.

That is very useful for correcting Basic programs without having to re-enter complete lines, and also for repeating commands. The cursor control keys were, unfortunately, a little awkward — the shifted position must be used for certain directions. The facility could have been made so much better by the addition of two extra keys and a better key lay-out for the cursor keys.

DOS 2.1 is an improvement on the original DOS for the Pet, but not a enormous one. It is still slightly primitive, for example, in requiring the opening and closing of files. They were awkward, requiring the user to remember three code numbers. Program files have to be loaded separately and the command run entered before they can be executed. In many other DOSs under Basic, one can call the program by run "filename" and it is loaded and executed in one command.

Intelligent disc drive

The plus point is that the disc drive is intelligent containing its own 6502 processor. In theory, the 2040 is capable of processing while the 8032 is running.

A demonstration test disc was enclosed with the drive. Running the diagnostic program from the disc called Diagnostic Boot, revealed that there might be a fault. The test suggested that the ROM 6332 at position K1 or the 74LS42 at position B3 could be suspect. This was further borne out by a DOS error on the documentation program called Pet Disc where after a good deal of the program had run the message:

```
Disc Error
CBM DOS v2 73 18 4
```

was displayed. The number codes were perhaps an error message, but I could not find that error code in the manual and using the command PRINT DSS to obtain the error message gave a message which told me it was correct — not very helpful.

Also, on loading the DOS Support program, the direct disc commands did not work, which was a disappointment as they looked useful. The response from the system on using the direct commands was syntax error, which could have been due to incompatibilities or differences between the 8032 and the Pet 2000 series, rather than the disc fault mentioned.

The manual on the disc drive gave the Poke command to obtain upper-case alphabets on the display which were accepted by the Basic. It was:

```
POKE 59468, 12
```

However, some commands required certain characters to be shifted, and the

Software supplied on disc

CP/M, Version 2.11, plus:
 Microsoft Basic 80, versions 4 and 5
 BACKUP — system-specific disc copier
 RAID — on-screen program simulator, extended-8080 mnemonics in the disassembler portion of the display
 SCOPE — on-screen text editor
 ZSM — assembler for extended-8080 mnemonics
 CONFIG — CP/M re-configurer
 Micropolis MDOS, plus:
 MBasic
 Line editor
 Equivalent of ZSM
 Equivalent of CONFIG
 Games.

shifted character may be under those conditions, to be one of the graphics characters. The disc drives recorded in 5¼in. mini-floppy discs on double-density, soft-sectored format giving approximately 170Kbytes per drive storage. That is adequate only for small business applications. For more flexibility and better capacity for handling data, one needs .5Mbyte to 1Mbyte storage as minimum.

Again, mini-floppy discs were designed originally for the hobbyist market; for higher capacity, Commodore has had to turn to double-sided discs and even double-tracking.

Upper and lower-case characters are available, but they were not the usual ASCII values. The lower-case alphabets, in fact, had ASCII values for the upper-case characters, and the upper-case characters on the 8032 had totally-unrelated values.

That is an important point to bear in mind, especially if inter-machine communications were envisaged. If inter-machine communications are not to another CBM 8000 series, there may well be difficulties.

There is a large set of graphics characters available — around 100. They look the same as those for the Pet, useful, and

The Commodore Tractor printer.

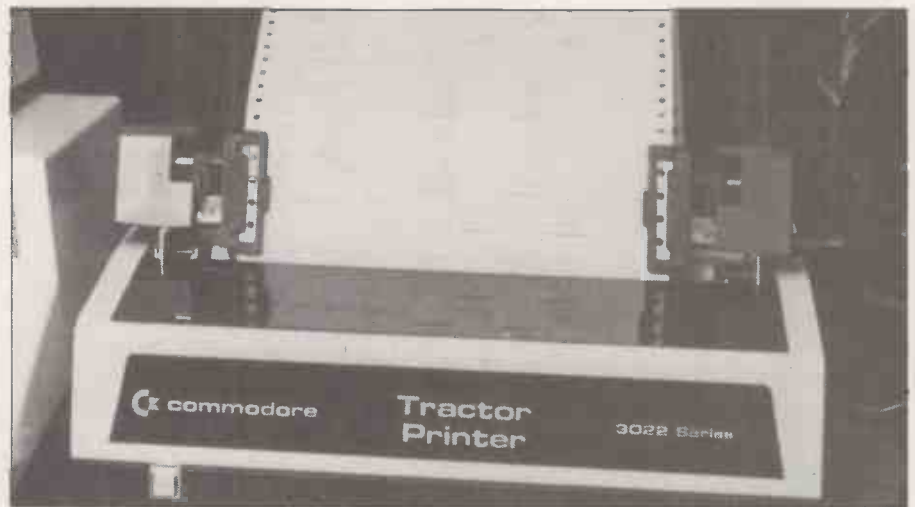

the ones used on the demonstration software seem reasonably good.

Like the Pet, the CBM 8032 still retains the IEEE-488 standard parallel interface via which most devices are attached in a cascade manner, e.g., the disc was attached on the interface. Although the IEEE-488 is a recognised standard interface, it is not very common in computing, where the RS232C/V-24 serial standard is more usual. It will retain compatibility to the Pet and Pet peripherals.

The other interfaces were a user parallel port, and connections for an external cassette recorder — they were the three connectors exposed from the holes in the casing. Two other connections were available inside and were for memory expansion and one for the internal cassette.

The electronics is contained on a single board. The lay-out is neat with plenty of space between components and the power supply regulator circuitry is also on the same board. Access to the single board is very good, although access to the CRT tube is not as easy and there is no easy way to rotate the scan deflectors to correct for the slanting display.

The CBM 8032 has only a 60-page users' guide which was perhaps an inadequate explanation for a user to realise the full potential of the machine. For example, the graphics characters are not even mentioned. The guide seemed more like a promotional booklet showing the peripherals available for the CBM 8032. No doubt the documentation will improve as it did for the original Pet. The user manual for the disc system was better.

Conclusions

- The CBM 8032 has many features in common with the older version Pet.
- Its main concession to business computing is its larger screen suitable for word processing.
- The SuperPet can use most of the peripherals and even software for the Pet.
- As far as software is concerned, programs using Peek and Poke statements may not be transferable between the two machines.

U.S. Presidential



Election

In a sophisticated recreation of the flavour of the U.S. Presidential election, Alan Bayliss presents a program which leads the players through the in-party intrigue, the manipulation of primary elections and press to the climax of the race for Presidential power on election day.

In a U.S. Presidential election, two people challenge for the leadership. Each is from a different political party, either of which is capable of winning the election, and both of which are likely to receive similar popular support nationwide.

The electoral system used involves voting in each State, with the candidate who receives most votes winning that state. Each State is worth a certain number of votes in the Electoral College and it is ultimately the number of State votes which each candidate wins which determines the new President rather than their total popular votes.

Media-orientated

A U.S. election is heavily media-orientated and involves great financial expenditure in adverts for, say, TV. Those adverts are designed to convert the floating voters to voting for one or other of the candidates.

Local issues can also play their part in the election — that can be seen where similar States in an area tend to vote the same way, e.g., the southern States.

As the results are announced, those from the East Coast arrive before those on the West Coast, because of the different time zones involved. U.S. TV typically shows the results as graphical displays and attempts to predict the outcome of the election based on the results as they arrive.

The program, written in Basic for a 32K Exidy Sorcerer, attempts to recreate as much of the flavour of the election and the tension, as the results are announced.

The program is designed round two main segments — the one- and two-player games — which call on subroutines to perform the various activities required. This procedure reduces the repetition between these sections and allows for easy expansion of the facilities.

Sections common to both the one- and two-player games form the start of the program. After reading that information and receiving the details of which version is required, the program calls on the Print-Map subroutine and the Print-States subroutine.

The map is constructed from a series of Poke commands which individually push a single graphics character into the video output section of the memory.

State shading

Originally, the shading of the individual States was executed in the same way but it was found to occupy too much of the available memory space, so it was modified so that a series of similar graphic characters are Poked-in using a for/next loop subroutine — lines 9000+. That saved up to 7K of memory at the acceptable cost of printing the State at a slower rate.

Since the names and positions of the States are not widely known, the name and number of State votes are displayed above the map as the State returning its votes is being flashed on and off.

This State is displayed on the screen using the white character set, but those States which have been won by either player utilise that player's colour for their display.

The game is based on the premiss that the more money spent in a State, the better the chance of gaining a majority of the popular votes and thus obtaining its State votes, the eventual winner being the one who wins most of those votes.

Naturally, it is not completely the case, as the personality of the candidate and the area of the country in which the State is situated have an important influence.

| Variables | | | |
|--|----------------------------|----------|------------------------------------|
| The following variables are used in the program. () indicates a dimensioned variable. | | | |
| VARIABLE | DEFINITION | VARIABLE | DEFINITION |
| A\$() | State names | H0 | Predicted outcome |
| B () | State votes | H1 | Of state votes |
| C () | State popular votes | I | |
| D () | State selection list | J | For/next loop variables |
| E () | State vote totals | K | |
| F () | Player's money remaining | L | Winner's number |
| G () | State point totals | Q | Current state number |
| H () | Current leader | Q1 | Random dummy |
| M () | Popular vote totals | Q1\$ | Information variable |
| N () | State points | Q2 | Close result |
| | Winner's number | | Random number |
| P () | State display | Q3 | User routine dummy |
| | Winner's number | | |
| | Short game:state | R | Random seed |
| S () | Expenditure per State vote | | |
| V () | Money spend on state | S | Popular votes calculation variable |
| Z\$() | Players' names | S1 | Extra money variable |
| A | State shading graphics | S2 | Short game calculation variable |
| A1 | User-defined graphics | T | Turn number |
| B1→4 | State shading graphics | U | Number of players in game |
| D1→4 | State drawing variables | X | Random number |
| H | Time delay variable | X\$ | Underlining constant |

To simulate that, States adjacent to the current game turn's State exert an influence over it, giving a benefit to whoever won them. The effect that these States have is further complicated by the drawing of two national boundary lines, dividing the country into three areas. Across the boundaries, the States exert much less influence.

This effect was calculated from the following main rules:

- The number of State points from an adjacent State was equal to half that State's state votes — fractions being discounted.
- The larger States — in terms of State votes — could exert an influence further away but the State points would be very much reduced.

Maximum figure

The nett effect of these rules can be seen in figure 3, where the State Points are listed. For any particular State, the points for each player are calculated and the difference is multiplied by 750 to give a nett State effects contribution to the player having the most points.

Although the maximum figure which can ever be added to a players total is a nett of 30,000 — in fact, one player has +15,000, the other -15,000 — in practice,

Glossary

Popular Votes — the number of votes obtained by the candidates in an election.

State effects — the addition to — or subtraction from — the player's money, fixed and random numbers in any State, from the State points multiplied by 750.

State information — the player's display, showing the amount of money that he has left, the State name, State votes, opinion polls and current performance details.

State points — any State is influenced by the results in surrounding States which hold a certain number of State points for it. These points go to whoever has won those States and then the difference in each player's holding of points is calculated. The player with the most State points has this difference multiplied by 750 to give a State effects contribution.

State results — the display showing the actual result, winner's name, totals of State and popular votes and predicted result details.

State votes — each State is allocated a number of State votes based, in part, on the number of Senators each State has. The winner of each State gains the State votes for that State and the new President is the person to obtain 270 — a majority — of the State votes.

it is usually much less, unless a player has won most of the States in an area.

To the player's expenditure on a State is added the State effects contribution, a fixed number and a random number. This total is converted into a percentage and

from that, the votes each player apparently obtained are calculated and reflect the size of the population in that State.

To prevent one person from obtaining an extremely low number of votes — the worst case is 10 percent — a cut-off at 25 percent is provided. In the event of the result being close — the two totals being within two percent of each other — a Close Result subroutine, lines 4400+, calculates the final result in a more random manner, including a time delay before displaying the result, to heighten the tension.

Money display

The players are presented with a display for each State listing their money available and current performance. The inclusion of the Opinion-Polls subroutine gives the players some idea as to the effect that the adjacent States are having on that turn's State.

That figure is weighted to take into account the size of the State — in terms of its votes — and the probable money each player would enter. Also included in the display is a summary of the current State-votes position indicating how many more are required for a player to win.

The results are displayed in a format

(continued on next page)

Figure 1. Map diagram.

KEY

Screen size 30x64

Lines used 27

Graphic character
(generated by
subroutine line 5000)

State boundary
(generated by
subroutines lines
10000 +)

State name X
(generated by
subroutine line)

State number 10
(refers to line number
for state shading
details)
e.g., state 2 = line 10200

National North/South,
East/West boundary

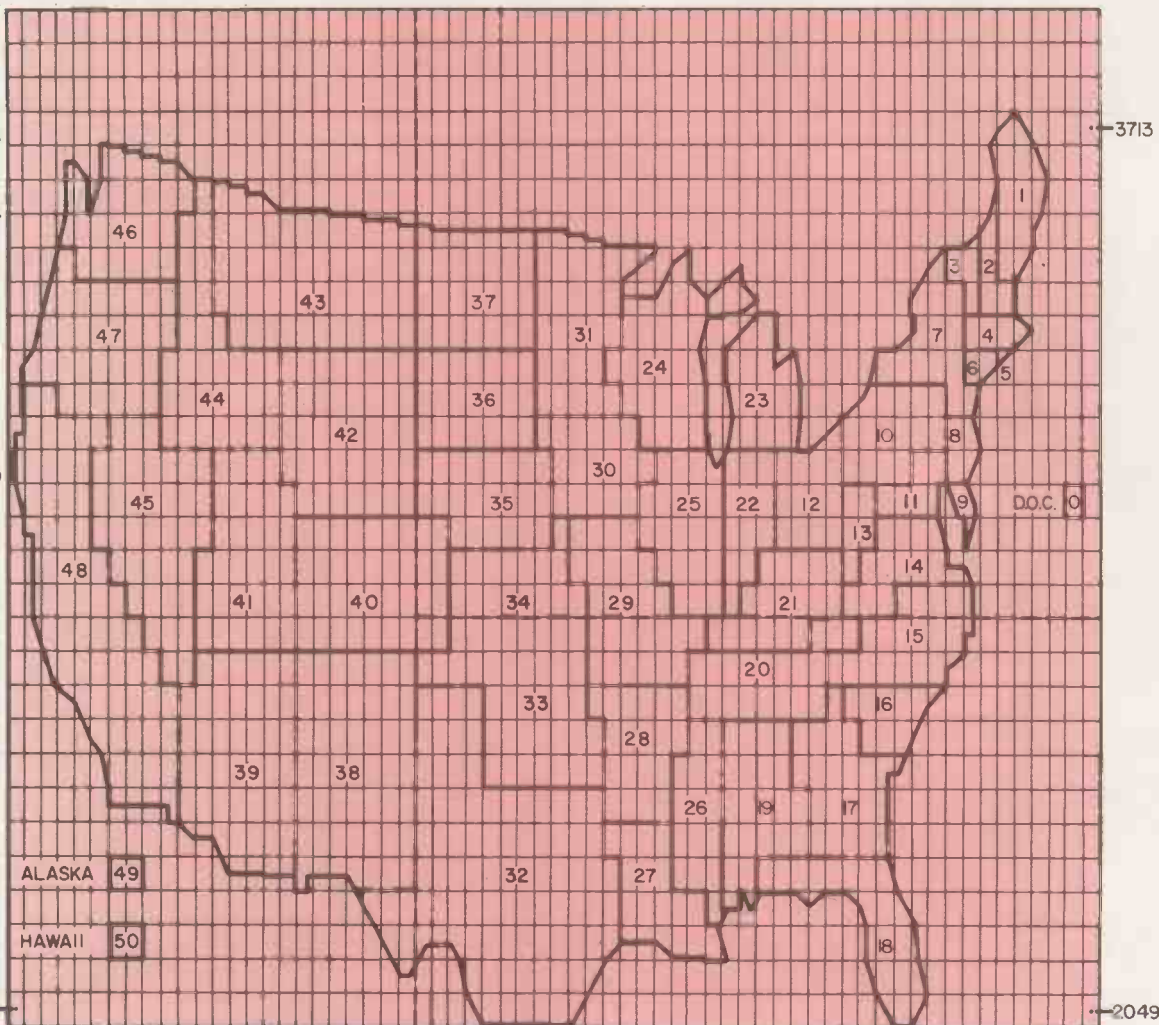

Screen co-ordinate 2112

(continued from previous page)

showing the winning player, the votes obtained and the totals to date. More importantly, the present totals of the State votes are shown and from these the Predictor-Result subroutine, lines 2900, calculates the final result on the basis of the State votes obtained and the percentage of the popular votes each player has.

Useful guide

Although not being accurate for the first 10 or so State results, as the game progresses the error is reduced and it provides a useful guide as to who is likely to win.

The first State is chosen from a list containing the first 15 States. The States have been numbered consecutively from east to west. Once the result has been calculated

for a particular State, its number is replaced on the list by the next unused one.

Eventually, less than 15 States will remain and a dummy market is used to replace them as they are chosen. The number has no effect in game terms and causes the program to re-select until a valid State is chosen. The net effect of this section is to give the impression of the results arriving from the East Coast before those from the West.

Although not required to be a fast program to run, much of the bookkeeping work is done while the players are reading information displayed on the screen. This includes the updating of the State effects, which is carried-out before the program returns to printing the map, States won and indicating the next game turns State.

Figure 2. A complete list of the graphics characters used in the program with their reference numbers.

| Ref no | | Ref no | | Ref no | | Ref no | |
|--------|---|--------|---|--------|---|--------|---|
| 128 | | 167 | █ | 196 | | 213 | ↘ |
| 131 | | 168 | █ | 197 | ↘ | 214 | — |
| 135 | | 169 | █ | 198 | ↘ | 215 | └ |
| 137 | — | 170 | █ | 199 | ↘ | 216 | — |
| 138 | — | 171 | ↘ | 200 | ↘ | 217 | |
| 139 | — | 172 | ↘ | 201 | ↘ | 218 | |
| 140 | — | 174 | — | 202 | ↘ | 219 | █ |
| 144 | ⤿ | 175 | — | 203 | — | 220 | ▣ |
| 147 | ▴ | 176 | — | 204 | | 221 | ▣ |
| 148 | ▴ | 177 | ▣ | 205 | ↘ | 222 | ▣ |
| 149 | █ | 181 | ▣ | 206 | ↘ | 223 | ▴ |
| 150 | █ | 184 | ▣ | 207 | ↘ | 224 | ▴ |
| 154 | ⤿ | 188 | └ | 208 | ↘ | 225 | ▣ |
| 158 | ▴ | 189 | └ | 209 | └ | 226 | ▣ |
| 159 | ▴ | 192 | ↘ | 210 | ↘ | 227 | ▴ |
| 160 | █ | 193 | ↘ | 211 | ↘ | 228 | ▣ |
| 161 | █ | 194 | ↘ | 212 | ↘ | 229 | ▴ |
| 162 | | 195 | ↘ | | | | |

Subroutines

| Line No. | Description |
|----------|---------------------------|
| 500 | TWO PLAYER GAME |
| 2100 | STATE RESULTS PRINTOUT |
| 2200 | STATE INFORMATION DISPLAY |
| 2300 | CALCULATE OPINION POLLS |
| 2400 | FLASH RANDOM STATE |
| 2500 | ONE PLAYER GAME |
| 2600 | BASIC INSTRUCTIONS |
| 2700 | PRINT VOTES TOTALS |
| 2800 | PRINT STATES |
| 2900 | PREDICTED RESULTS |
| 3000 | CLEAR SCREEN |
| 3100 | LIMIT STATE EFFECTS |
| 3200 | END OF GAME |
| 3300 | RANDOM STATE SELECTION |
| 3400 | VOTES CALCULATION |
| 3500 | UPDATE STATE EFFECTS |
| 3900 | STATE SHADING |
| 4000 | STATE DRAWING |
| 4300 | NEGATIVE RESULT |
| 4400 | CLOSE RESULT |
| 4500 | SHORT GAME |
| 4800 | HOW TO PLAY (1 PLAYER) |
| 4900 | HOW TO PLAY (2 PLAYERS) |
| 5000 | AMERICAN MAP DETAILS |
| 6000 | STATE NAME DISPLAY |
| 7000 | RETURN FROM SHORT GAME |
| 10000 | STATE MAP DETAILS |

On completion of the 51st State result, the program jumps to the End-Game subroutine, lines 3200, where the winner's name is printed within the map and all the States are shown in their correct shadings.

The addition of several print lines removes the cursor from within the map area and ensures that the prompt-ready following the completion of the program, appears at the bottom of the screen. The program is terminated by an end statement rather than a stop command which causes two lines of printing and distorts the final display.

One-player game

The one-player game is similar to the two-player game in its output and construction. The main difference being that there is only one State information display before the result, the computer inputting the money for the second player according to a fixed equation.

In addition to the two main games, there is the Short-Game variation, lines 4500, which is included to reduce the length of playing time from about 45 minutes to as little as five — depending on when the game is chosen.

This game is reached by the first player on any turn, inputting a figure greater than 1,000,000 on his expenditure in any State. The Short game displays only a modified results picture indicating the State, winner's name, current voting positions and the predicted result.

The results are calculated in the same way as the normal games with the computer allocating the players resources to each State based on its number of State votes and the amount of money remaining.

To return to the normal game, a machine-language subroutine has been included, which scans the keyboard for a few seconds after every result to check whether a key is being pressed. If one is, the computer is directed to return to what-

(continued from previous page)

State name and the player's names and votes obtained. The winner's name is printed and a summary of the new State votes and total popular votes is also displayed. Should the result have been close — the winner receiving less than 51 percent of the votes — the Close-Result subroutine will have been called and is indicated.

The results display also shows the predicted final result and here an assessment on the outcome of the election has been made, based on the previous results.

After several seconds, the results display is replaced by the map and all States where the results have been calculated are displayed in a colour — white or grey — dependent on who had won them. The computer then selects a new State and flashes it on to the map before displaying the State information.

In the two-player game, the previous turns second player becomes the first player for the new game turn, thus each person takes it in turn to be the first to enter their expenditure on the States throughout the game. In the one-player game, it does not apply.

Within the standard game, the program identifies the entry of a negative amount of money for any State, as a request for more money, and after it has been input allows a positive value to be spent on that State. An attempt to spend more money than a player has left is also recognised and that player is penalised.

The cycle of entering money/displaying results is repeated for all 51 States. After the last result, the winners name is displayed and the map and shaded States superimposed over it. A normal game played this way would take about 45 minutes to complete.

In addition to the standard game, a quicker version has been provided, accessible by typing in a number greater than 1,000,000 as the first player's expenditure in any State. In the two-player version, the computer calculates both players' expenditure for the State based on their remaining money and the size of the State — in terms of State votes.

| Symbol | Ref no | Code | Symbol | Ref no | Code |
|--------|--------|----------------------------|--------|--------|----------------------------|
| | 192 | 00 00 00 00 01 02 04 08 | | 211 | 00 00 00 0F 10 20 40 80 |
| | 193 | 03 0C 30 C0 00 00 00 00 | | 212 | 01 02 04 08 F0 00 00 00 |
| | 194 | 01 01 02 02 04 04 08 08 | | 213 | 08 04 02 01 00 00 00 00 |
| | 195 | 10 20 40 80 00 00 00 00 | | 214 | F0 00 00 00 00 00 00 00 |
| | 196 | 00 00 00 00 01 01 01 01 | | 215 | 00 00 00 00 FF 01 01 01 |
| | 197 | 00 00 00 00 03 0C 30 C0 | | 216 | 0F 00 00 00 00 00 00 00 |
| | 198 | C0 30 0C 03 03 0C 30 C0 | | 217 | 80 80 80 80 00 00 00 00 |
| | 199 | 08 08 04 04 02 02 01 01 | | 218 | 00 00 00 00 80 80 80 80 |
| | 200 | 80 40 20 10 08 08 08 08 | | 219 | FF FF FF FF FF FF FF FF |
| | 201 | 10 10 20 20 40 40 80 80 | | 220 | 00 00 00 00 05 0A 05 0A |
| | 202 | 80 80 40 40 20 20 10 1F | | 221 | 50 A0 50 A0 00 00 00 00 |
| | 203 | 00 00 00 00 00 00 00 0F | | 222 | 05 0A 05 0A 05 0A 05 0A |
| | 204 | 01 01 01 01 00 00 00 00 | | 223 | 00 80 40 A0 50 A8 54 AA |
| | 205 | 80 80 40 40 20 20 10 10 | | 224 | 55 AA 54 A8 50 A0 40 80 |
| | 206 | C0 30 0C 03 00 00 00 00 | | 225 | 55 AA 55 AA 00 00 00 00 |
| | 207 | 00 00 00 00 80 40 20 10 | | 226 | 05 0A 05 0A 00 00 00 00 |
| | 208 | 81 42 24 18 00 00 00 00 | | 227 | 55 2A 15 0A 05 02 01 00 |
| | 209 | 01 01 01 01 FF 00 00 00 | | 228 | 00 00 00 00 50 A0 50 A0 |
| | 210 | 00 00 00 00 C0 30 0C 03 | | 229 | 01 02 05 0A 15 2A 55 AA |

Figure 4. The pre-defined Sorcerer graphics characters used by the program — lines 1-24.

```

1 REM USER DEFINABLE GRAPHICS
5 FOR I = 0 TO 303
6 READ A1: POKE —512+I,A1
7 NEXT I
10 DATA 0,0,0,0,1,2,3,8,3,12,48,192,0,0,0,0,1,1,2,2,4,4,8,8
11 DATA 16,32,64,128,0,0,0,0,0,0,0,0,1,1,1,1,0,0,0,0,3,12,48,192
12 DATA 192,48,12,3,3,12,48,192,8,8,4,4,2,2,1,1,128,64,32,16,8,8,8,8
13 DATA 16,16,32,32,64,64,128,128,128,128,64,64,32,32,16,31
14 DATA 0,0,0,0,0,0,0,15,1,1,1,0,0,0,0,128,128,64,64,32,16,16
15 DATA 192,48,12,3,0,0,0,0,0,0,128,64,32,16,129,66,36,24,0,0,0,0,
16 DATA 1,1,1,1,255,0,0,0,0,0,0,192,48,12,3,0,0,0,15,16,32,64,128
17 DATA 1,2,4,8,240,0,0,0,8,4,2,1,0,0,0,0,240,0,0,0,0,0,0,0,0,
18 DATA 0,0,0,0,255,1,1,1,15,0,0,0,0,0,0,128,128,128,128,0,0,0,0,
19 DATA 0,0,0,0,128,128,128,128,255,255,255,255,255,255,255,255
20 DATA 0,0,0,0,5,10,5,10,80,160,80,160,0,0,0,0,5,10,5,10,5,10,
21 DATA 0,128,64,160,80,160,84,170,85,170,84,168,80,160,64,128
22 DATA 85,170,85,170,0,0,0,5,10,5,10,0,0,0,0,
23 DATA 85,42,21,10,5,2,1,0,0,0,0,80,160,80,160
24 DATA 1,2,5,10,21,42,85,170
30 DIM A$(50),B$(50),C$(3),D$(14),E(1),F(1),G$(50),M(3),H(1)
31 DIM N$(50),P$(50),V(1),Z$(1),S(1)
40 FOR I = 0 TO 50: READ A$(I),B(I): NEXT I
45 DATA "DISTRICT OF COLUMBIA",3,"MAIN",4,"NEW HAMPSHIRE",4
46 DATA "VERMONT",3,"MASSACHUSETTS",14,"RHODE ISLAND",4
47 DATA "CONNECTICUT",8,"NEW YORK",41,"NEW JERSEY",17
48 DATA "DELAWARE",3,"PENNSYLVANIA",27,"MARYLAND",10
49 DATA "OHIO",25,"WEST VIRGINIA",6,"VIRGINIA",12
50 DATA "NORTH CAROLINA",13,"SOUTH CAROLINA",8,"GEORGIA",12
51 DATA "FLORIDA",17,"ALABAMA",9,"TENNESSEE",10
52 DATA "KENTUCKY",9,"INDIANA",13,"MICHIGAN",21
53 DATA "WISCONSIN",11,"ILLINOIS",26,"MISSISSIPPI",7
54 DATA "LOUISIANA",10,"ARKANSAS",6,"MISSOURI",12
55 DATA "IOWA",8,"MINNESOTA",10,"TEXAS",26
56 DATA "OKLAHOMA",8,"KANSAS",7,"NEBRASKA",5
57 DATA "SOUTH DAKOTA",4,"NORTH DAKOTA",3,"COLORADO",7
58 DATA "NEW MEXICO",4,"ARIZONA",6,"UTAH",4
59 DATA "WYOMING",3,"MONTANA",4,"IDAHO",4
60 DATA "NEVADA",3,"WASHINGTON",9,"OREGON",6
61 DATA "CALIFORNIA",45,"ALASKA",3,"HAWAII",4
65 F(0) = 1 E 6 : F(1) = F(0)
70 FOR I = 0 TO 14: D(I) = 1 : NEXT I
72 POKE 260,32 : POKE 261,0
74 POKE 32,205:POKE 33,24:POKE 34,224:POKE 35,50
76 POKE 36,0 :POKE 37,0 :POKE 38,201
78 T = 1
80 X$ = " _____ " [REM: LENGTH OF X$

```



```

20 SPACES]
85 FOR I = 0 TO 50 : P(I) = 9 : N(I) = 0 : NEXT I
90 REM HEADING INFORMATION
95 GOSUB 3000
100 PRINT TAB(20); "THE AMERICAN ELECTION GAME"
105 PRINT TAB(20); "-----"
110 PRINT:PRINT
120 PRINT TAB(15); "DO YOU WANT INSTRUCTIONS — TYPE YES
OR NO"
130 INPUT Q15 : IF Q15 = "YES" THEN GOSUB 2600
140 PRINT TAB(15); "TYPE IN TIME (OR A SIMILAR RANDOM
NUMBER)"
150 INPUT R
160 Q1 = RND(-R)
170 PRINT TAB(15); "ARE THERE ONE OR TWO PEOPLE IN THIS
GAME?"
175 PRINT TAB(15); "ENTER THE NUMBER 1 OR 2 ΔΔ"; INPUT U
176 IF Q15 < > "YES" GOTO 180
178 ON U GOSUB 4800, 4900
180 ON U GOTO 2500, 2000
190 GOTO 175
200 PRINT:PRINT TAB(15); "PLEASE TYPE IN YOUR NAMES"
210 INPUT Z5(0), Z5(1)
220 GOSUB 5000
230 GOSUB 2400
500 REM TWO PLAYER NORMAL GAME
510 GOSUB 3000
520 IF RIGHT$(STR$(T*5), 1) = "5" GOTO 540
530 K = 1 : GOTO 550
540 K = 0
550 GOSUB 2300
600 FOR I = 1 TO 2
610 GOSUB 2200
620 K = K + 1
630 IF K = 2 THEN K = 0
640 NEXT I
700 GOSUB 2100
800 IF T = 51 GOTO 3200
810 GOSUB 5000
820 T = T + 1
850 GOTO 230
2100 REM STATE RESULTS DISPLAY
2104 GOSUB 3400
2108 PRINT TAB(15); "THE RESULT IN THE STATE OF Δ"; A5(Q)
2112 PRINT TAB(24); "IS AS FOLLOWS":PRINT
2116 IF C(0) < 0.49 OR C(0) = 0.51 GOTO 2140
2120 PRINT TAB(20); "WOW!!! Δ A CLOSE RESULT"
2124 PRINT TAB(19); "THERE MUST BE A RECOUNT":PRINT
2128 GOSUB 4400
2132 FOR I = 1 TO 500:NEXT I
2136 PRINT TAB(17); "AND HERE IS THE FINAL RESULT":PRINT
2140 GOSUB 3450
2144 FOR I = 0 TO 1
2148 PRINT:PRINT TAB(15); Z5(1); TAB(30); C(I); "Δ VOTES"; TAB(55);
C(I+2); "Δ %"
2152 NEXT I
2156 PRINT:PRINT TAB(15); "MAJORITY"; TAB(31); ABS(C(0) - C(1))
2160 PRINT:PRINT TAB(15); "THE WINNER OF THIS STATE IS Δ"; Z5(L)
2165 GOSUB 2700
2170 GOSUB 2900
2175 IF 14 + T < 51 GOTO 2185
2180 D(X) = 99 : GOTO 2190
2185 D(X) = 14 + T
2190 FOR I = 1 TO 2000 : NEXT I
2195 GOSUB 3500
2199 RETURN
2200 REM STATE INFORMATION DISPLAY
2205 V(K) = 0
2210 PRINT TAB(25); A5(Q); TAB(50); "RESULT NO. "; T
2215 PRINT TAB(25); LEFT$(X$, LEN(A5(Q)))
2220 PRINT:PRINT
2223 PRINT:PRINT TAB(15); "THIS STATE IS WORTH Δ"; B(Q); "Δ VOTES"
2226 PRINT:PRINT
2229 PRINT TAB(15); Z5(K); ", YOU HAVE $"; F(K); "LEFT TO SPEND"
2232 PRINT:PRINT
2235 PRINT TAB(15); "THE LATEST OPINION POLLS SHOW THAT"
2238 PRINT TAB(12); "YOU HAVE"; C(K); "Δ % OF THE VOTES IN THIS
STATE"
2241 PRINT:PRINT TAB(17); "CURRENTLY, YOU HAVE"; E(K); "Δ
VOTES"
2244 M = K + 1 : IF M = 2 THEN M = 0
2247 PRINT TAB(15); "AND YOUR OPPONENT HAS"; E(M); "Δ VOTES"
2250 IF E(K) >= 270 GOTO 2259
2253 IF E(M) = 270 GOTO 2262
2256 PRINT TAB(13); "SO YOU NEED ANOTHER"; 270 - E(K); "Δ VOTES
TO WIN":GOTO 2265
2259 PRINT TAB(20); "BUT YOU HAVE A MAJORITY":GOTO 2265
2262 PRINT TAB(17); "BUT YOU CANNOT GET A MAJORITY"
2265 PRINT:PRINT TAB(15); "TYPE IN HOW MUCH YOU WISH TO
SPEND":INPUT V(K)
2268 IF I = 1 AND V(K) > 1 E 6 GOTO 4500
2269 IF I < 2 OR V(K) <= 1 E 6 GOTO 2271
2270 PRINT "ONLY THE FIRST PLAYER CAN REACH THE FAST
GAME":GOTO 2265
2271 IF V(K) >= 0 GOTO 2282
2274 PRINT TAB(10); "IT LOOKS AS IF YOU ARE REQUESTING MORE
MONEY"
2277 PRINT TAB(17); "TYPE IN HOW MUCH EXTRA YOU WANT"
2280 INPUT S1 : F(K) = F(K) + S1 : GOSUB 3000
2281 GOTO 2205
2282 F(K) = F(K) - V(K) : IF F(K) <= 0 GOTO 2292
2284 PRINT:PRINT TAB(15); "YOU GOOFED AND OVERSPENT YOUR
ALLOWED BUDGET"
2286 PRINT TAB(13); "WITH YOUR OPPONENT REVEALING THIS TO
THE ELECTORS"
2288 PRINT TAB(15); "IN THIS STATE, IT MUST HAVE COST YOU
VOTES"
2290 FOR H = 1 TO 2000:NEXT H : V(K) = F(K) : F(K) = 0
2292 IF V(K) <= B(Q) * 2000 GOTO 2296
2294 V(K) = B(Q) * 2000 + (V(K) - B(Q) * 2000) / EXP(RND(1))
2296 GOSUB 3000
2298 RETURN
2300 REM CALC OPINION POLLS
2310 GOSUB 3100
2320 C(0) = 45000 - G(Q) * 750 + B(Q) * 1000
2330 C(0) = INT(C(0) * 100 / (90000 + B(Q) * 2000))
2340 C(1) = 100 - C(0)
2350 RETURN
2400 REM FLASH RND STATE
2410 GOSUB 3300
2420 GOSUB 6000
2430 FOR I = 1 TO 5
2440 GOSUB 3900
2450 GOSUB 4000
2460 A = 32 : A2 = A : A3 = A : A4 = A : A5 = A : A6 = A
2470 A7 = A : A8 = A : A9 = A : B1 = A : B2 = A : B3 = A : B4 = A
2480 GOSUB 4000
2490 NEXT I
2495 RETURN
2500 REM ONE PLAYER GAME
2505 PRINT:PRINT TAB(15); "PLEASE TYPE IN YOUR NAME ΔΔ";
:INPUT Z5(0)
2510 Z5(1) = "COMPUTER"
2515 GOSUB 5000
2520 GOSUB 2400
2525 GOSUB 2300
2530 GOSUB 3000
2535 K = 0 : I = 1 : GOSUB 2200
2540 V(1) = B(Q) * 2200
2550 GOSUB 2100
2555 IF T = 51 GOTO 3200
2560 GOSUB 5000
2565 GOSUB 2800
2575 T = T + 1
2580 GOTO 2520
2600 REM INSTRUCTIONS
2602 PRINT:PRINT "This game is a simulation of the PRESIDENTIAL";
2604 PRINT "Δ ELECTIONS":PRINT "It can be played by ONE or TWO
persons."
2606 PRINT "ΔΔΔΔΔ Each player takes it in turn to enter the amount"
2608 PRINT "of money that they wish to spend in the current State."
2610 PRINT "The higher the figure the better the chance of winning"
2612 PRINT "it, and taking its State Votes to add to their total."
2614 PRINT "The aim is to be the person to reach 270 State Votes,"
2616 PRINT "and the various displays will help you on your way."
2618 PRINT "ΔΔΔΔΔ There is an Opinion Polls section to give you an"
2620 PRINT "idea of how you stand in a particular State before you"
2622 PRINT "decide how much you want to spend there. And after the"
2624 PRINT "the result has been announced the computer will give its"
2626 PRINT "latest prediction on who is likely to win. A map printed"
2628 PRINT "after every result shows who has won each state and acts"
2630 PRINT "as an aid to future strategy."
2632 PRINT:PRINT "ΔΔΔΔΔ Because the standard game takes 45 minutes to
play."
2634 PRINT "a shorter version is also available. To reach this game the"
2636 PRINT "first player on any turn must enter a number greater than"
2638 PRINT "1 million (1000000) instead of spending money on that State."
2640 PRINT "You can get back to the standard game whenever you like,"
2642 PRINT "simply by pressing one of the keys when asked to."
2644 PRINT "ΔΔΔΔΔ If you do run out of money or feel like you deserve"
2646 PRINT "more (who doesn't?) you can get some extra by typing a"
2648 PRINT "negative (-) number as the amount of money to be spent"
2650 PRINT "for that State. ΔΔΔ Now to start —"
2660 RETURN
2700 REM PRINT VOTES TOTALS
2705 PRINT:PRINT TAB(15); "THE CURRENT VOTING POSITION IS AS
FOLLOWS"
2710 IF E(0) >= E(1) THEN H(0) = 1
2715 IF E(1) >= E(0) THEN H(1) = 1
2720 FOR I = 0 TO 1
2725 PRINT:PRINT TAB(15); Z5(I); TAB(30); E(I); "Δ VOTES Δ";
2730 IF I = 0 AND H(I) = 0 THEN PRINT
2735 IF H(I) = 0 GOTO 2765
2740 IF E(I) > 269 GOTO 2755
2745 PRINT "("; 270 - E(I); "MORE VOTES REQD)"
2750 GOTO 2760
2755 PRINT "(HAS NOW A MAJORITY)"
2760 H(I) = 0
2765 NEXT I
2770 PRINT
2775 FOR I = 0 TO 1:PRINT
2780 PRINT TAB(14); "Δ"; Z5(I), M(I); "Δ POPULAR VOTES"; TAB(55);
M(I+2); "Δ %"
2785 NEXT I
2790 RETURN
2800 REM PRINT STATES
2810 FOR I = 0 TO 50
2820 IF P(I) = 9 GOTO 2880
2830 Q = 1 : IF P(I) = 1 GOTO 2860

```

(continued on page 73)

POWERFUL MICROS

AT THE RIGHT PRICE

- Multi-User ● Multi-Tasking
- Multi-Language ● Hard Disc Storage ● Word Processing
- Priced from under £5000

Languages supported include – Basic, Cobol, Fortran.
OEM, Educational and Dealer enquiries invited

EQUINOX

COMPUTER SYSTEMS LIMITED
Kleeman House, 16 Anning Street
New Inn Yard, London EC2A 3HB
Tel: 01-739 2387 & 01-729 4460

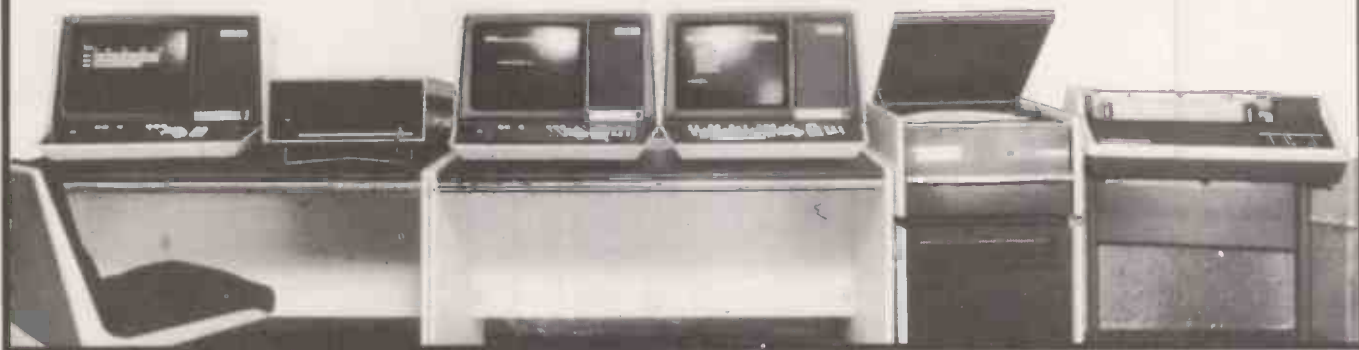

ELIMINATE YOUR BACK-UP PROBLEMS

with our low cost cartridge drive



PRICE
£3950*
PLUS VAT

*One-off OEM price

The Equinox KB10 Cartridge Drive allows S100 microsystems to transfer, read and write data at high speed. Its 5MB fixed and 5MB removable discs eliminate the need to provide separate data back-up. The removable 5MB disc allows for fast back-up and therefore unlimited off-line storage. Without sacrificing high performance, multiple users can operate the Equinox KB10 simultaneously using multi-user software. Equinox provides support for such software i.e., MVT/FAMOS, MP/M and OMNIX. CP/M is also supported.

EQUINOX

COMPUTER SYSTEMS LIMITED

Kleeman House, 16 Anning Street, New Inn Yard,
London EC2A 3HB. Tel: 01-739 2387/9 and 01-729 4460

• Circle No. 167

(continued from page 71)

```

2840 GOSUB 3900
2850 GOTO 2870
2860 GOSUB 3950
2870 GOSUB 4000
2880 NEXT I
2890 RETURN
2900 REM PREDICTED OUTCOME
2910 H0 = INT(.538 - E(0) - E(1)) * M(2) / 100 + E(0)
2920 H1 = 538 - H0
2930 PRINT:PRINT TAB(14); "THE LATEST PREDICTIONS ARE AS
FOLLOWS"
2940 PRINT TAB(14); ZS(0); TAB(30); H0; " Δ VOTES"
2950 PRINT TAB(14); ZS(1); TAB(30); H1; " Δ VOTES"
2960 RETURN
3000 REM CLEAR SCREEN
3010 PRINT CHR$(12)
3020 PRINT:PRINT:PRINT:PRINT:PRINT:PRINT
3030 RETURN
3100 REM LIMIT STATE EFFECTS
3110 IF ABS(G(Q)) > 40 GOTO 3150
3120 G(Q) = G(Q) / 2 : GOTO 3180
3150 IF SGN(G(Q)) = -1 GOTO 3170
3160 G(Q) = 20 : GOTO 3180
3170 G(Q) = -20
3180 RETURN
3200 REM END OF GAME
3205 FOR I = 1 TO 1500:NEXT I
3210 IF E(0) > E(1) THEN L = 0
3220 IF E(1) > E(0) THEN L = 1
3230 GOSUB 3000
3235 GOSUB 3020 : PRINT
3240 IF E(0) = E(1) GOTO 3270
3250 PRINT TAB(15); "CONGRATULATIONS, "; ZS(L); " Δ YOU ARE
THE"
3255 PRINT TAB(20); "NEW PRESIDENT OF THE U.S.A."
3260 PRINT TAB(15); "*****"
3265 GOTO 3280
3270 PRINT TAB(14); "CONGRATULATIONS, YOU HAVE ACHIEVED
A DRAW"
3275 PRINT TAB(22); "HOW ABOUT TRYING AGAIN?"
3280 FOR I = 1 TO 10:PRINT:NEXT I
3285 GOSUB 5005
3290 GOSUB 2800
3295 END
3300 REM RANDOM STATE
3310 X = INT(15 * RND(1))
3320 IF D(X) = 99 GOTO 3310
3330 Q = D(X)
3340 RETURN
3400 REM VOTES CALC.
3410 C(0) = V(0) - G(Q) * 750 + 25000 + 40000 * RND(1)
3420 C(1) = V(1) + G(Q) * 750 + 25000 + 40000 * RND(1)
3430 S = C(0) + C(1)
3440 C(2) = INT(C(0) * 100 / S); C(3) = INT(C(1) * 100 / S)
3445 C(0) = C(0) / S : C(1) = C(1) / S
3449 RETURN
3450 C(0) = INT(C(0) * B(Q) * 190000); C(1) = INT(C(1) * B(Q) * 190000)
3460 IF C(2) < 25 OR C(3) < 25 THEN GOSUB 4300
3470 M(0) = M(0) + C(0); M(1) = M(1) + C(1)
3472 (M2) = INT(M(0) * 100 / (M(0) + M(1))); M(3) = INT(M(1) * 100 / (M(0) +
M(1)))
3475 IF C(0) > C(1) THEN L = 0
3480 IF C(1) > C(0) THEN L = 1
3485 E(L) = E(L) + B(Q); P(Q) = L
3488 IF L = 0 THEN N(Q) = -1
3490 IF L = 1 THEN N(Q) = 1
3495 RETURN
3500 REM UPDATE STATE EFFECTS
3505 G(0) = 2 * N(7) + 4 * N(8) + 6 * N(10) + 5 * N(11) + 3 * N(12) + N(13)
3510 G(0) = G(0) + 6 * N(14) + N(15) + N(20)
3515 G(1) = 2 * N(2) + 3 * N(4) + N(6) + 5 * N(7) + N(10)
3520 G(2) = 2 * N(1) + N(3) + 7 * N(4) + 4 * N(5) + 2 * N(6) + 20 * N(7) + N(8) + 6 * N(10)
+ N(11)
3525 G(3) = N(1) + 2 * N(2) + 7 * N(4) + 2 * N(6) + 20 * N(7) + N(8) + 6 * N(10) + N(11)
3530 G(4) = N(1) + 2 * N(2) + N(3) + 2 * N(5) + 4 * N(6) + 20 * N(7) + 2 * N(8)
3535 G(4) = G(4) + 6 * N(10) + N(11)
3540 G(5) = N(2) + 7 * N(4) + 4 * N(6) + 10 * N(7) + 2 * N(8) + 3 * N(10)
3545 G(6) = N(2) + 7 * N(4) + 2 * N(5) + 20 * N(7) + 4 * N(8) + 6 * N(10) + N(11) +
N(12)
3550 G(7) = N(3) + 7 * N(4) + 4 * N(6) + 8 * N(8) + 13 * N(10) + 2 * N(11) + 6 * N(12)
3555 G(7) = G(7) + N(13) + N(14)
3560 G(8) = N(2) + 3 * N(4) + 2 * N(6) + 20 * N(7) + N(9) + 13 * N(10) + 5 * N(11)
3564 G(8) = G(8) + 6 * N(12) + 3 * N(14)
3568 G(9) = N(4) + N(6) + 5 * N(7) + 8 * N(8) + 6 * N(10) + 5 * N(11) + 3 * N(12) + 3 *
N(14)
3572 G(10) = N(4) + N(6) + 20 * N(7) + 8 * N(8) + 5 * N(11) + 12 * N(12) + 3 * N(13)
3576 G(10) = G(10) + 3 * N(14) + 2 * N(21) + 3 * N(22) + 5 * N(23)
3580 G(11) = N(0) + N(4) + N(6) + 5 * N(7) + 8 * N(8) + N(9) + 13 * N(10) + 6 * N(12)
3584 G(11) = G(11) + 3 * N(13) + 6 * N(14) + N(15) + 2 * N(21) + N(22) + 2 * N(23)
3588 G(12) = 10 * N(7) + 13 * N(10) + 2 * N(11) + 3 * N(13) + 3 * N(14) + N(20)
3592 G(12) = G(12) + 4 * N(21) + 6 * N(22) + 10 * N(23) + N(24) + 6 * N(25) + N(29)
3596 G(13) = 10 * N(7) + 4 * N(8) + 6 * N(10) + 5 * N(11) + 12 * N(12) + 6 * N(14)
3600 G(13) = G(13) + N(15) + N(20) + 4 * N(21) + 3 * N(22) + 5 * N(23) + 3 * N(25)
3604 G(14) = N(0) + 2 * N(7) + 4 * N(8) + 5 * N(11) + 6 * N(12) + 3 * N(13) + 6 * N(15)
3608 G(14) = G(14) + N(16) + N(17) + 5 * N(20) + 4 * N(21) + N(22) + 2 * N(23) + 3 *
N(25)
3612 G(15) = N(8) + 2 * N(10) + N(11) + N(12) + 6 * N(14) + 4 * N(16) + 6 * N(17)
3616 G(15) = G(15) + 3 * N(18) + 2 * N(19) + 5 * N(20) + 2 * N(21)
3620 G(16) = N(14) + 6 * N(15) + 6 * N(17) + 4 * N(18) + 2 * N(19) + N(21)
3624 G(17) = 6 * N(15) + 4 * N(16) + 8 * N(18) + 4 * N(19) + 5 * N(20) + 2 * N(21)
3628 G(17) = G(17) + N(26) + N(27)

```

```

3632 G(18) = 3 * N(15) + 2 * N(16) + 6 * N(17) + 4 * N(19) + 2 * N(20) + N(26) + N(27)
3636 G(19) = 3 * N(15) + N(16) + 6 * N(17) + 8 * N(18) + 5 * N(20) + 2 * N(21) + 3 *
N(26)
3639 G(19) = G(19) + 2 * N(27) + N(28) + N(29) + 3 * N(32)
3642 G(20) = 3 * N(12) + 3 * N(14) + 6 * N(15) + 2 * N(16) + 6 * N(17) + 4 * N(18)
3645 G(20) = G(20) + 4 * N(19) + 4 * N(21) + N(22) + N(23) + 3 * N(25) + 3 * N(26)
3648 G(20) = G(20) + 2 * N(27) + 3 * N(28) + 6 * N(29) + 3 * N(32)
3651 G(21) = N(7) + 3 * N(10) + N(11) + 12 * N(12) + 3 * N(13) + 6 * N(14) + N(15)
3654 G(21) = G(21) + N(17) + N(18) + N(19) + 5 * N(20) + 6 * N(22) + 5 * N(23)
3657 G(21) = G(21) + 2 * N(24) + 13 * N(25) + N(26) + N(28) + 6 * N(29)
3660 G(22) = N(7) + 6 * N(10) + N(11) + 12 * N(12) + 3 * N(14) + N(20) + 4 * N(21)
3663 G(22) = G(22) + 10 * N(23) + 2 * N(24) + 13 * N(25) + 3 * N(29) + 2 * N(30)
3666 G(23) = 3 * N(10) + N(11) + 12 * N(12) + 2 * N(21) + 6 * N(22) + 5 * N(24)
3669 G(23) = G(23) + 6 * N(25) + N(29) + N(31)
3672 G(24) = 3 * N(12) + N(21) + 3 * N(22) + 10 * N(23) + 13 * N(25) + 3 * N(29)
3675 G(24) = G(24) + 4 * N(30) + 5 * N(31)
3678 G(25) = 3 * N(10) + 6 * N(12) + N(14) + N(20) + 4 * N(21) + 6 * N(22)
3681 G(25) = G(25) + 5 * N(23) + 5 * N(24) + 6 * N(29) + 4 * N(30) + 2 * N(31)
3684 G(26) = N(15) + 3 * N(17) + 4 * N(18) + 4 * N(19) + 5 * N(20) + 2 * N(21)
3687 G(26) = G(26) + 5 * N(27) + 3 * N(28) + 3 * N(29) + 6 * N(32) + 2 * N(33)
3690 G(27) = N(17) + 2 * N(18) + 2 * N(19) + 2 * N(20) + 3 * N(26) + 3 * N(28)
3693 G(27) = G(27) + 3 * N(29) + 13 * N(32) + 2 * N(33)
3696 G(28) = N(17) + 2 * N(18) + 2 * N(19) + 5 * N(20) + 2 * N(21) + 3 * N(25)
3699 G(28) = G(28) + 3 * N(26) + 5 * N(27) + 6 * N(29) + 13 * N(32) + 4 * N(33)
3702 G(29) = N(15) + N(17) + 5 * N(20) + 4 * N(21) + 2 * N(22) + N(23) + 2 * N(24)
3705 G(29) = G(29) + 13 * N(25) + N(26) + 2 * N(27) + 3 * N(28) + 4 * N(30)
3708 G(29) = G(29) + 2 * N(31) + 3 * N(32) + 4 * N(33) + 3 * N(34) + N(35)
3711 G(30) = N(12) + 3 * N(22) + 2 * N(23) + 5 * N(24) + 13 * N(25) + 6 * N(29)
3714 G(30) = G(30) + 5 * N(31) + 3 * N(34) + 2 * N(35) + 2 * N(36)
3717 G(31) = 2 * N(23) + 5 * N(24) + 6 * N(25) + 3 * N(29) + 4 * N(30) + N(35)
3720 G(31) = G(31) + 2 * N(36) + N(37)
3723 G(32) = N(18) + N(19) + N(26) + 5 * N(27) + 3 * N(28) + 3 * N(29) + N(38)
3726 G(32) = G(32) + 2 * N(39)
3729 G(33) = 2 * N(20) + N(25) + N(26) + 2 * N(27) + 3 * N(28) + 6 * N(29) + 2 * N(30)
3732 G(33) = G(33) + 13 * N(32) + 3 * N(34) + 3 * N(38) + 2 * N(39)
3735 G(34) = N(24) + 5 * N(25) + N(28) + 6 * N(29) + 4 * N(30) + N(31) + 4 * N(32)
3738 G(34) = G(34) + 4 * N(33) + 2 * N(35) + 3 * N(38)
3741 G(35) = N(24) + 5 * N(25) + 3 * N(29) + 4 * N(30) + 2 * N(31) + N(32) + 2 * N(36)
3744 G(35) = G(35) + 3 * N(38) + N(42)
3747 G(36) = N(24) + 2 * N(25) + 3 * N(29) + 4 * N(30) + 5 * N(31) + N(34) + 2 * N(35)
3750 (G36) = G(36) + N(37) + N(42)
3753 G(37) = N(24) + 2 * N(30) + 5 * N(31) + 2 * N(36) + 2 * N(43)
3756 G(38) = N(29) + 5 * N(32) + 4 * N(33) + 3 * N(34) + 2 * N(35) + 2 * N(39) + N(40)
3759 G(38) = G(38) + 2 * N(41) + N(42) + N(48)
3762 G(39) = 13 * N(32) + 4 * N(33) + 3 * N(38) + 3 * N(40) + 11 * N(48)
3765 G(40) = 3 * N(32) + 2 * N(38) + 2 * N(39) + 2 * N(41) + N(45) + 22 * N(48)
3768 G(41) = N(32) + 3 * N(38) + N(39) + 3 * N(40) + N(42) + 2 * N(44) + N(45)
3771 G(41) = G(41) + 11 * N(48)
3774 G(42) = N(32) + 2 * N(35) + 2 * N(36) + 2 * N(38) + 2 * N(41) + 2 * N(43) + 2 *
N(44)
3777 G(43) = N(37) + 2 * N(44) + 2 * N(46) + N(47)
3780 G(44) = 2 * N(41) + 2 * N(43) + N(45) + 4 * N(46) + 3 * N(47) + 11 * N(48)
3783 G(45) = 3 * N(40) + 2 * N(41) + 2 * N(44) + 2 * N(46) + 3 * N(47) + 22 * N(48)
3786 G(46) = N(43) + 2 * N(44) + 3 * N(47) + 11 * N(48)
3789 G(47) = 2 * N(44) + N(45) + 4 * N(46) + 22 * N(48)
3792 G(48) = 3 * N(40) + N(45) + 2 * N(46) + 3 * N(47)
3795 RETURN
3900 REM STATE SHADING (0)
3910 A = 219: A2 = 168: A3 = 158: A4 = 147: A5 = 149: A6 = 161
3920 A7 = 170: A8 = 169: A9 = 167: B1 = 160: B2 = 148: B3 = 150: B4 = 159
3930 RETURN
3950 REM STATE SHADING (1)
3960 A = 177: A2 = 222: A3 = 223: A4 = 224: A5 = 220: A6 = 221
3970 A7 = 184: A8 = 225: A9 = 181: B1 = 226: B2 = 227: B3 = 228: B4 = 229
3980 RETURN
4000 REM STATE DRAWING
4010 ON Q + 1 GOSUB 10000, 10100, 10200, 10300, 10400, 10500, 10600
4020 IF Q = 6 <= 0 GOTO 4200
4030 ON Q = 6 GOSUB 10700, 10800, 10900, 11000, 11100, 11200, 11300
4040 IF Q = 13 <= 0 GOTO 4200
4050 ON Q = 13 GOSUB 11400, 11500, 11600, 11700, 11800, 11900, 12000
4060 IF Q = 20 <= 0 GOTO 4200
4070 ON Q = 20 GOSUB 12100, 12200, 12300, 12400, 12500, 12600, 12700
4080 IF Q = 27 <= 0 GOTO 4200
4090 ON Q = 27 GOSUB 12800, 12900, 13000, 13100, 13200, 13300, 13400
4100 IF Q = 34 <= 0 GOTO 4200
4110 ON Q = 34 GOSUB 13500, 13600, 13700, 13800, 13900, 14000, 14100
4120 IF Q = 41 <= 0 GOTO 4200
4130 ON Q = 41 GOSUB 14200, 14300, 14400, 14500, 14600, 14700, 14800
4140 IF Q = 48 <= 0 GOTO 4200
4150 ON Q = 48 GOSUB 14900, 15000
4160 RETURN
4300 REM NEGATIVE RESULT
4310 IF C(2) > 25 GOTO 4350
4320 C(0) = INT(0.25 * B(Q) * 190000); C(1) = INT(0.75 * B(Q) * 190000)
4330 C(2) = 25: C(3) = 75: GOTO 4390
4350 C(0) = INT(0.75 * B(Q) * 190000); C(1) = INT(0.25 * B(Q) * 190000)
4360 C(2) = 75: C(3) = 25
4390 RETURN
4400 REM CLOSE RESULT
4410 Q2 = RND(1)
4420 IF Q2 <= 0.5 THEN C(0) = C(0) - 0.005
4430 IF Q2 > 0.5 THEN C(0) = C(0) + 0.005
4440 IF C(0) > 0.49 AND C(0) < 0.51 GOTO 4410
4450 C(2) = INT(C(0) * 100 / (C(0) + C(1))); C(3) = INT(C(1) * 100 / (C(0) + C(1)))
4490 RETURN
4500 REM SHORT GAME
4510 GOSUB 3000
4515 S2 = 540 - E(0) - E(1)
4520 FOR I = 0 TO 1 : S(I) = F(I) / S2 : NEXT I
4525 PRINT:PRINT

```

(continued on next page)

(continued from previous page)

```
4530 PRINT TAB(14); "To return to standard game, press any key"
4535 FOR I=0 TO 150:Q3=USR(0):IF PEEK(0)<>0 GOTO 7000
4540 NEXT I
4545 GOSUB 3000
4550 GOSUB 3100
4555 FOR I=0 TO 1:V(I)=S(I)*B(Q):NEXT I
4560 IF U=1 THEN V(I)=B(Q)*2200
4565 GOSUB 3400
4570 IF C(0)>0.49 AND C(0)<0.51 THEN GOSUB 4400
4575 GOSUB 3450
4580 PRINT:PRINT
4585 PRINT TAB(15); "RESULT NO.":T
4590 PRINT TAB(15); "THE WINNER OF THE STATE OF A":A5(Q)
4595 PRINT TAB(15); "IS A":Z5(L); "Δ BY":ABS(C(0)-C(1)); "Δ VOTES"
4600 GOSUB 2700
4605 FOR I=0 TO 1:F(I)=INT(F(I)-V(I)):NEXT I
4610 GOSUB 2900
4615 IF T+14<51 GOTO 4625
4620 D(X)=99:GOTO 4630
4625 D(X)=14+T
4630 IF T=51 GOTO 3200
4635 GOSUB 3300
4640 GOSUB 3500
4645 T=T+1
4650 GOTO 4525
4800 REM ONE PLAYER INSTRUCTIONS
4802 PRINT "ΔΔΔΔ So you're on your own are you. Well it isn't going"
4804 PRINT "to be easy to defeat the computer but here are a few"
4806 PRINT "hints as to how to set about doing just that."
4808 PRINT:PRINT "ΔΔΔΔ For a start the computer will always spend"
4810 PRINT "$2200 * The Number Of State Votes in any State."
4812 PRINT "That means in a 4 vote State it is using about $9000"
4814 PRINT "whilst in the big 40 vote States it will spend $90000 +"
4816 PRINT "To make matters worse, if you try to match him,"
4818 PRINT "any money that you spend over $2000 * State Votes"
4820 PRINT "suffers by being reduced by anything up to 40% of its"
4822 PRINT "true value. (So in a worst case $30000 spend in a"
4824 PRINT "10 vote State could become only $24000, only slightly"
4826 PRINT "more than the computer has put in.)"
4828 PRINT "ΔΔΔΔ However most of the States affect the results in"
4830 PRINT "adjacent States (or in the case of the bigger vote"
4832 PRINT "States, those even further away ) and contribute a"
4834 PRINT "significant bonus to whoever has won the States which"
4836 PRINT "surround the one in play. ΔΔ This is of course what the"
4838 PRINT "Opinion Polls are for, indicating the advantage (if any)"
4840 PRINT "that you hold in a State before you spend your money."
4842 PRINT "ΔΔΔΔ So to stand a chance you must go for all the big"
4844 PRINT "States irrespective of cost and win as many of the early"
4846 PRINT "ones as possible. Δ Your money should run out after about"
4848 PRINT "35 States but by then you should be near to winning. If"
4850 PRINT "you are still a long way off, there's always next time."
4852 PRINT "ΔΔΔΔ Good Luck and may the best person win (That rules"
4854 PRINT "out the computer!)"
4856 RETURN
4900 REM TWO PLAYER INSTRUCTIONS
4902 PRINT "ΔΔΔΔ In the standard game each player takes it in turn to"
4904 PRINT "be the first to enter the amount of money to be spend"
4906 PRINT "on any individual State. ΔΔ This is because it is a"
4908 PRINT "disadvantage to be the first player — the second"
4910 PRINT "one knows how much he must spend to win!"
4912 PRINT "ΔΔΔΔ However the game isn't that easy, since putting in a"
4914 PRINT "greater amount of money won't necessarily win a State"
4916 PRINT "for you. Δ This is where the Opinion Polls can be a guide"
4918 PRINT "for you. Δ A popularity of 55% in a State means that it can"
4920 PRINT "normally be won by putting in the same amount as your"
4922 PRINT "opponent. Δ Over 60% and you can think about putting in less"
4924 PRINT "and still win."
4926 PRINT "ΔΔΔΔ If you are the first person to put their money in"
4928 PRINT "a State, the main things to think of are as follows —"
4930 PRINT "Δ (1) Δ Is it a big enough State to risk spending a lot on"
4932 PRINT "After all if your opponent is going to win it, at least"
4934 PRINT "make it as expensive as possible."
4936 PRINT "Δ (2) Δ Can you afford to lose it?"
4938 PRINT "If it is a big State then the benefits from winning it"
4940 PRINT "can be enormous in terms of the effect that it has on"
4942 PRINT "the surrounding States. The more money you put in the"
4944 PRINT "closer the result will be, perhaps you might even pick up"
4946 PRINT "the State on a recount. Beware if you let your opponent"
4948 PRINT "get a Predicted Result of over 300 Votes, because it is"
4950 PRINT "very difficult to pull back from this."
4952 PRINT "ΔΔΔΔ In the end may the best person win (well America"
4954 PRINT "needs all the help that it can get!)"
4990 RETURN
5000 REM PRINT AMERICA
5002 GOSUB 3000
5005 POKE—3719,192:POKE—3718,193:POKE—3717,172:POKE—3652,172
5010 POKE—3588,194:POKE—3524,195:POKE—3525,196:POKE—3461,171
5015 POKE—3397,128:POKE—3343,62:POKE—3271,197:POKE—3270,193
5020 POKE—3333,198:POKE—3208,194:POKE—3144,199:POKE—3080,171
5025 POKE—3016,200:POKE—2952,201:POKE—2953,135:POKE—3016,200
5030 POKE—3017,202:POKE—3082,203:POKE—3018,162:POKE—2954,154
5035 POKE—2890,204:POKE—2889,140:POKE—2888,144:POKE—2824,162
5040 POKE—2760,191:POKE—2761,196:POKE—2697,193:POKE—2698,196
5045 POKE—2634,193:POKE—2635,192:POKE—2571,195:POKE—2572,192
5050 POKE—2508,195:POKE—2509,188:POKE—2445,162:POKE—2381,162
5055 POKE—2317,199:POKE—2252,172:POKE—2187,205:POKE—2123,199
5060 POKE—2059,171:POKE—2060,176:POKE—1996,206:POKE—2061,172
5065 POKE—2126,199:POKE—2190,162:POKE—2254,207:POKE—2255,206
5070 POKE—2256,137:POKE—2257,193:POKE—2258,206:POKE—2259,137
5075 POKE—2260,137:POKE—2261,208:POKE—2262,209:POKE—2263,192
5080 POKE—2199,199:POKE—2135,137:POKE—2200,176:POKE—2201,176
5085 POKE—2202,210:POKE—2083,176:POKE—2084,176:POKE—2085,172
5090 POKE—2150,199:POKE—2214,207:POKE—2215,140:POKE—2216,211
5095 POKE—2153,212:POKE—2154,213:POKE—2218,207:POKE—2219,213
5100 POKE—2283,207:POKE—2284,213:POKE—2348,207:POKE—2349,140
5105 POKE—2350,140:POKE—2351,188:POKE—2287,214:POKE—2352,215
5110 POKE—2353,140:POKE—2354,139:POKE—2355,140:POKE—2356,213
5115 POKE—2420,207:POKE—2421,140:POKE—2422,206:POKE—2423,216
5120 POKE—2487,189:POKE—2488,140:POKE—2489,140:POKE—2490,140
5125 POKE—2491,204:POKE—2555,199:POKE—2619,207:POKE—2620,213
5130 POKE—2684,207:POKE—2685,206:POKE—2686,216:POKE—2750,205
5135 POKE—2815,199:POKE—2879,131:POKE—2943,131:POKE—3007,189
5140 POKE—3008,204:POKE—3072,199:POKE—3136,131:POKE—3200,189
5145 POKE—3199,217:POKE—3264,135:POKE—3328,196:POKE—3327,195
5150 POKE—3391,194:POKE—3454,201:POKE—3518,194:POKE—3581,201
5155 POKE—3645,131:POKE—3709,188:POKE—3708,210:POKE—3644,135
5160 POKE—3643,201:POKE—3707,131:POKE—3771,203:POKE—3706,137
5165 POKE—3705,138:POKE—3704,139:POKE—3703,140:POKE—3702,210
5170 POKE—3637,137:POKE—3636,138:POKE—3635,139:POKE—3634,140
5175 POKE—3633,210:POKE—3632,176:POKE—3631,176:POKE—3630,176
5180 POKE—3565,137:POKE—3564,137:POKE—3563,138:POKE—3562,138
5185 POKE—3561,139:POKE—3560,139:POKE—3559,140:POKE—3558,140
5190 POKE—3557,140:POKE—3556,140:POKE—3555,139:POKE—3554,139
5195 POKE—3553,139:POKE—3552,140:POKE—3551,174:POKE—3550,175
5200 POKE—3549,176:POKE—3548,176:POKE—3547,176:POKE—3483,193
5205 POKE—3484,197:POKE—3421,204:POKE—3420,140:POKE—3419,140
5210 POKE—3418,195:POKE—3482,192:POKE—3481,193:POKE—3480,128
5215 POKE—3416,206:POKE—3415,193:POKE—3478,197:POKE—3477,218
5220 POKE—3413,198:POKE—3414,176:POKE—3351,137:POKE—3352,194
5225 POKE—3288,199:POKE—3224,135:POKE—3160,204:POKE—3159,218
5230 POKE—3095,208:POKE—3158,201:POKE—3222,205:POKE—3286,128
5235 POKE—3350,197:POKE—3349,193:POKE—3412,176:POKE—3347,128
5240 POKE—3284,204:POKE—3283,193:POKE—3282,205:POKE—3218,131
5245 POKE—3154,201:POKE—3090,137:POKE—3153,197:POKE—3152,193
5250 POKE—3215,197:POKE—3214,195:POKE—3278,194:POKE—3277,137
5255 POKE—3340,197:POKE—3339,217:POKE—3404,196:POKE—3403,195
5260 POKE—3467,192:POKE—3466,193:POKE—3529,176:POKE—3528,197
5265 POKE—3527,195:POKE—3591,194:POKE—3655,199
5270 POKE—2368,65:POKE—2367,76:POKE—2366,65:POKE—2365,83
5275 POKE—2364,75:POKE—2363,65:POKE—2362,135:POKE—2361,137
5280 POKE—2360,128:POKE—2297,137
5285 POKE—2240,72:POKE—2239,65:POKE—2238,87:POKE—2237,65
5290 POKE—2236,73:POKE—2235,73:POKE—2234,135:POKE—2233,137
5295 POKE—2232,128:POKE—2169,137
5300 POKE—3014,68:POKE—3013,79:POKE—3012,67:POKE—3011,135
5305 POKE—3010,137:POKE—3009,128:POKE—2946,137
5310 RETURN
6000 REM PRINT STATE NAME
6010 FOR J=1 TO LEN(A5(Q))
6020 M=ASC(MID$(A5(Q),J))
6030 POKE—3752+J,M
6040 NEXT J
6050 FOR K=J+1 TO LEN(STR$(B(Q)))+J
6060 M=ASC(MID$(STR$(B(Q)),K-J))
6070 POKE—3752+K,M
6080 NEXT K
6090 RETURN
7000 REM RETURN FROM SHORT GAME
7010 ON U GOTO 2520,500
9000 REM STATE DRAWING (2)
9010 FOR J=0 TO D1 STEP D2
9020 FOR K=0 TO D3
9030 POKE—D4+J+K,A
9040 NEXT K:NEXT J
9050 RETURN
10000 REM DOC
10005 POKE—3010,A
10095 RETURN
10100 REM MAINE
10105 D1=128:D2=64:D3=1:D4=3654:GOSUB 9000
10110 POKE—3588,A:POKE—3462,A:POKE—3718,A:POKE—3655,A2
10115 POKE—3717,A3:POKE—3652,A3:POKE—3461,A4:POKE—3719,A5
10120 POKE—3524,A6
10195 RETURN
10200 REM NEW HAMPSHIRE
10205 POKE—3399,A:POKE—3398,A:POKE—3463,A:POKE—3527,A
10210 POKE—3591,A5
10295 RETURN
10300 REM VERMONT
10305 POKE—3400,A:POKE—3464,A:POKE—3465,A:POKE—3528,A7
10395 RETURN
10400 REM MASS.
10405 D1=0:D2=0:D3=3:D4=3336:GOSUB 9000
10495 RETURN
10500 REM RHD ISL
10505 POKE—3270,A8
10595 RETURN
10600 REM CONNECTICUT
10605 POKE—3272,A:POKE—3271,A
10695 RETURN
10700 REM NEW YORK
10705 D1=128:D2=64:D3=2:D4=3403:GOSUB 9000
10710 POKE—3208,A9:POKE—3209,A:POKE—3276,A:POKE—3277,A
10715 POKE—3278,A5:POKE—3340,A7:POKE—3466,A:POKE—3467,A5
10795 RETURN
10800 REM NEW JERSEY
10805 D1=64:D2=64:D3=1:D4=3145:GOSUB 9000
10895 RETURN
10900 REM DELAWARE
10905 POKE—3017,A:POKE—3016,A9:POKE—2952,A9
10995 RETURN
11000 REM PENNS.
11005 D1=126:D2=63:D3=3:D4=3213:GOSUB 9000
```

| | |
|-------|--|
| 11010 | POKE—3214,A:POKE—3215,A7:POKE—3146,A:POKE—3151,A |
| 11095 | RETURN |
| 11100 | REM MARYLAND |
| 11105 | POKE—3082,A:POKE—3083,A:POKE—3018,A9:POKE—3019,A |
| 11110 | POKE—3020,A:POKE—3021,A |
| 11195 | RETURN |
| 11200 | REM OHIO |
| 11205 | D1 = 128:D2 = 64:D3 = 3:D4 = 3091:GOSUB 9000 |
| 11210 | POKE—3152,A:POKE—3153,A |
| 11295 | RETURN |
| 11300 | REM W. VIRG. |
| 11305 | D1 = 64:D2 = 64:D3 = 1:D4 = 3023:GOSUB 9000:POKE—2895,A |
| 11395 | RETURN |
| 11400 | RETURN |
| 11405 | D1 = 64:D2 = 64:D3 = 2:D4 = 2957:GOSUB 9000 |
| 11410 | POKE—2954,A9:POKE—2888,B3:POKE—2889,A7:POKE—2890,A |
| 11415 | POKE—2894,A:POKE—2829,A:POKE—2830,A:POKE—2831,A |
| 11495 | RETURN |
| 11500 | REM N. CAROL. |
| 11505 | D1 = 126:D2 = 63:D3 = 3:D4 = 2828:GOSUB 9000 |
| 11510 | POKE—2824,A9:POKE—2760,A6:POKE—2761,A:POKE—2766,A |
| 11515 | POKE—2697,A8:POKE—2698,A:POKE—2703,A:POKE—2704,A |
| 11520 | RETURN |
| 11500 | REM S. CAROL. |
| 11605 | D1 = 64:D2 = 64:D3 = 2:D4 = 2638:GOSUB 9000 |
| 11610 | POKE—2634,A8:POKE—2635,A:POKE—2639,A:POKE—2571,A6 |
| 11695 | RETURN |
| 11700 | REM GEORGIA |
| 11705 | D1 = 192:D2 = 64:D3 = 2:D4 = 2577:GOSUB 9000 |
| 11710 | POKE—2508,A6:POKE—2509,A:POKE—2510,A:POKE—2514,A |
| 11715 | POKE—2578,A:POKE—2640,A:POKE—2445,A9:POKE—2446,A |
| 11720 | POKE—2381,A:POKE—2382,A |
| 11795 | RETURN |
| 11800 | REM FLORIDA |
| 11805 | D1 = 0:D2 = 0:D3 = 7:D4 = 2324:GOSUB 9000 |
| 11810 | D3 = 2:D4 = 2125:GOSUB 9000 |
| 11815 | POKE—2252,A3:POKE—2253,A:POKE—2254,A:POKE—2255,B1 |
| 11820 | POKE—2257,A8:POKE—2258,A8:POKE—2187,A9:POKE—2188,A |
| 11825 | POKE—2189,A:POKE—2190,A2:POKE—2059,A4:POKE—2060,A |
| 11830 | POKE—2061,A:POKE—2126,A2 |
| 11895 | RETURN |
| 11900 | REM ALABAMA |
| 11905 | D1 = 192:D2 = 64:D3 = 3:D4 = 2582:GOSUB 9000 |
| 11910 | POKE—2450,A:POKE—2386,A:POKE—2325,A:POKE—2326,A |
| 11915 | POKE—2261,A8:POKE—2262,A8 |
| 11995 | RETURN |
| 12000 | REM TENN. |
| 12005 | D1 = 64:D2 = 64:D3 = 7:D4 = 2712:GOSUB 9000 |
| 12010 | POKE—2767,A:POKE—2768,A:POKE—2769,A |
| 12095 | RETURN |
| 12100 | REM KENTUCKY |
| 12105 | D1 = 126:D2 = 63:D3 = 4:D4 = 2900:GOSUB 9000 |
| 12110 | POKE—2832,A:POKE—2775,A |
| 12195 | RETURN |
| 12200 | REM INDIANA |
| 12205 | D1 = 128:D2 = 64:D3 = 2:D4 = 3094:GOSUB 9000 |
| 12210 | POKE—2901,A:POKE—2902,A:POKE—2838,A |
| 12295 | RETURN |
| 12300 | REM MICHIGAN |
| 12305 | D1 = 65:D2 = 65:D3 = 2:D4 = 3286:GOSUB 9000 |
| 12310 | D1 = 0:D2 = 0:D3 = 3:D4 = 3158:GOSUB 9000 |
| 12315 | POKE—3415,A:POKE—3414,A:POKE—3413,A9:POKE—3478,A7 |
| 12320 | POKE—3350,A7:POKE—3282,B3:POKE—3222,A2:POKE—3218,A9 |
| 12325 | POKE—3154,A9:POKE—3349,A7:POKE—3348,A:POKE—3283,A7 |
| 12395 | RETURN |
| 12400 | REM WISC. |
| 12405 | D1 = 128:D2 = 64:D3 = 3:D4 = 3356:GOSUB 9000 |
| 12410 | POKE—3482,A5:POKE—3481,A:POKE—3420,A7:POKE—3419,A7 |
| 12415 | POKE—3418,A:POKE—3417,A:POKE—3416,A:POKE—3352,A4 |
| 12420 | POKE—3293,A:POKE—3288,A3:POKE—3224,A:POKE—3163,A |
| 12425 | POKE—3162,A:POKE—3161,A:POKE—3160,A |
| 12495 | RETURN |
| 12500 | REM ILLINOIS |
| 12505 | D1 = 192:D2 = 64:D3 = 3:D4 = 3098:GOSUB 9000:POKE—2841,A |
| 12510 | POKE—3035,A:POKE—2971,A:POKE—2839,A:POKE—2840,A |
| 12595 | RETURN |
| 12600 | REM MISSISS. |
| 12605 | D1 = 192:D2 = 64:D3 = 2:D4 = 2521:GOSUB 9000 |
| 12610 | POKE—2584,A:POKE—2583,A:POKE—2263,A |
| 12695 | RETURN |
| 12700 | REM LOUIS. |
| 12705 | D1 = 128:D2 = 64:D3 = 2:D4 = 2396:GOSUB 9000 |
| 12710 | D1 = 0:D2 = 0:D3 = 3:D4 = 2202:GOSUB 9000:POKE—2203,A8 |
| 12715 | POKE—2397,A:POKE—2265,A:POKE—2264,A:POKE—2204,A8 |
| 12720 | RETURN |
| 12800 | REM ARKAN. |
| 12805 | D1 = 192:D2 = 64:D3 = 2:D4 = 2652:GOSUB 9000 |
| 12810 | POKE—2654,A:POKE—2653,A:POKE—2649,A:POKE—2589,A |
| 12815 | POKE—2885,A:POKE—2525,A:POKE—2461,A |
| 12895 | RETURN |
| 12900 | REM MISSOURI |
| 12905 | D1 = 195:D2 = 65:D3 = 3:D4 = 2975:GOSUB 9000 |
| 12910 | D1 = 0:D2 = 0:D3 = 5:D4 = 2718:GOSUB 9000:POKE—2844,A |
| 12915 | POKE—2911,A:POKE—2846,A:POKE—2782,A:POKE—2781,A |
| 12920 | POKE—2776,A:POKE—2907,A:POKE—2846,A:POKE—2845,A |
| 12995 | RETURN |
| 13000 | REM IOWA |
| 13005 | D1 = 128:D2 = 64:D3 = 4:D4 = 3168:GOSUB 9000 |
| 13010 | POKE—3169,A:POKE—3099,A |
| 13095 | RETURN |
| 13100 | REM MINNES. |
| 13105 | D1 = 256:D2 = 64:D3 = 3:D4 = 3489:GOSUB 9000 |
| 13110 | POKE—3553,A:POKE—3552,A:POKE—3551,A7:POKE—3550,A7 |
| 13115 | POKE—3485,A:POKE—3484,A:POKE—3483,A8:POKE—3421,A |
| 13120 | POKE—3357,A:POKE—3229,A |
| 13195 | RETURN |
| 13200 | REM TEXAS |
| 13205 | D1 = 128:D2 = 63:D3 = 3:D4 = 2664:GOSUB 9000 |
| 13210 | D1 = 192:D3 = 10:D4 = 2472:GOSUB 9000 |
| 13215 | D1 = 130:D2 = 65:D3 = 4:D4 = 2214:GOSUB 9000 |
| 13220 | D1 = 0:D2 = 0:D3 = 4:D4 = 2209:GOSUB 9000 |
| 13225 | POKE—2333,A:POKE—2284,B1:POKE—2283,A:POKE—2282,A |
| 13230 | POKE—2281,A:POKE—2269,A:POKE—2219,B1:POKE—2218,A |
| 13235 | POKE—2217,A:POKE—2261,A8:POKE—2215,A8:POKE—2154,B1 |
| 13240 | POKE—2153,A8:POKE—2150,B2:POKE—2144,A:POKE—2143,A |
| 13245 | POKE—2142,A4:POKE—2085,B2:POKE—2079,A4 |
| 13295 | RETURN |
| 13300 | REM OKLA. |
| 13305 | D1 = 192:D2 = 64:D3 = 5:D4 = 2724:GOSUB 9000 |
| 13310 | D1 = 0:D2 = 0:D3 = 3:D4 = 2728:GOSUB 9000 |
| 13315 | POKE—2590,A:POKE—2526,A |
| 13395 | RETURN |
| 13400 | REM KANSAS |
| 13405 | D1 = 128:D2 = 64:D3 = 6:D4 = 2918:GOSUB 9000 |
| 13410 | POKE—2976,A:POKE—2847,A:POKE—2783,A |
| 13495 | RETURN |
| 13500 | REM NEBRAS. |
| 13505 | D1 = 128:D2 = 64:D3 = 5:D4 = 3110:GOSUB 9000 |
| 13510 | D1 = 64:D3 = 1:D4 = 3112:GOSUB 9000 |
| 13595 | RETURN |
| 13600 | REM S. DAKOTA |
| 13605 | D1 = 128:D2 = 64:D3 = 6:D4 = 3304:GOSUB 9000 |
| 13695 | RETURN |
| 13700 | REM N. DAKOTA |
| 13705 | D1 = 192:D2 = 64:D3 = 6:D4 = 3560:GOSUB 9000 |
| 13790 | RETURN |
| 13800 | REM COLORADO |
| 13805 | D1 = 192:D2 = 64:D3 = 8:D4 = 2991:GOSUB 9000 |
| 13895 | RETURN |
| 13900 | REM NEW MEXICO |
| 13905 | D1 = 320:D2 = 64:D3 = 6:D4 = 2735:GOSUB 9000 |
| 13910 | D1 = 0:D2 = 0:D3 = 3:D4 = 2348:GOSUB 9000 |
| 13915 | POKE—2351,A:POKE—2350,A8:POKE—2349,A8 |
| 13995 | RETURN |
| 14000 | REM ARIZONA |
| 14005 | D1 = 256:D2 = 64:D3 = 5:D4 = 2741:GOSUB 9000 |
| 14010 | D1 = 0:D2 = 0:D3 = 4:D4 = 2420:GOSUB 9000 |
| 14015 | POKE—2678,A:POKE—2614,A:POKE—2550,A:POKE—2486,A |
| 14020 | POKE—2422,B1:POKE—2421,A8:POKE—2356,B1:POKE—2355,A8 |
| 14025 | POKE—2354,A8:POKE—2353,A8:POKE—2352,A8 |
| 14095 | RETURN |
| 14100 | REM UTAH |
| 14105 | D1 = 256:D2 = 64:D3 = 4:D4 = 3060:GOSUB 9000 |
| 14110 | D1 = 0:D2 = 0:D3 = 3:D4 = 3124:GOSUB 9000 |
| 14115 | POKE—2933,A:POKE—2869,A:POKE—2805,A |
| 14195 | RETURN |
| 14200 | REM WYOMING |
| 14205 | D1 = 256:D2 = 64:D3 = 6:D4 = 3311:GOSUB 9000 |
| 14210 | POKE—3312,A:POKE—3248,A:POKE—3184,A:POKE—3120,A |
| 14295 | RETURN |
| 14300 | REM MONTANA |
| 14305 | D1 = 192:D2 = 64:D3 = 10:D4 = 3571:GOSUB 9000 |
| 14310 | POKE—3636,A:POKE—3635,A:POKE—3634,A:POKE—3633,A3 |
| 14315 | POKE—3572,A:POKE—3508,A:POKE—3444,A |
| 14395 | RETURN |
| 14400 | REM IDAHO |
| 14405 | D1 = 128:D2 = 64:D3 = 6:D4 = 3319:GOSUB 9000 |
| 14410 | POKE—3637,A:POKE—3574,A:POKE—3573,A:POKE—3510,A |
| 14415 | POKE—3509,A:POKE—3446,A:POKE—3445,A:POKE—3382,A |
| 14420 | POKE—3381,A:POKE—3380,A |
| 14495 | RETURN |
| 14500 | REM NEVADA |
| 14505 | D1 = 128:D2 = 64:D3 = 6:D4 = 3131:GOSUB 9000 |
| 14510 | D1 = 192:D3 = 1:D4 = 2935:GOSUB 9000:POKE—2808,A |
| 14515 | POKE—3194,A:POKE—3193,A:POKE—3192,A:POKE—2938,A |
| 14520 | POKE—2937,A:POKE—2936,A:POKE—2873,A:POKE—2872,A |
| 14595 | RETURN |
| 14600 | REM WASHING. |
| 14605 | D1 = 128:D2 = 64:D3 = 5:D4 = 3644:GOSUB 9000 |
| 14610 | POKE—3709,A5:POKE—3708,A7:POKE—3707,A2:POKE—3706,A |
| 14615 | POKE—3705,A:POKE—3704,A:POKE—3703,A7:POKE—3702,A7 |
| 14620 | POKE—3645,A2:POKE—3638,A:POKE—3581,A |
| 14695 | RETURN |
| 14700 | REM OREGON |
| 14705 | D1 = 192:D2 = 64:D3 = 5:D4 = 3453:GOSUB 9000:POKE—3326,A |
| 14710 | POKE—3518,B4:POKE—3517,A:POKE—3454,A:POKE—3447,A |
| 14715 | POKE—3391,B4:POKE—3390,A:POKE—3383,A:POKE—3327,A |
| 14720 | RETURN |
| 14800 | REM CALIF. |
| 14805 | D1 = 192:D2 = 64:D3 = 3:D4 = 3199:GOSUB 9000 |
| 14810 | D1 = 128:D4 = 2942:GOSUB 9000 |
| 14815 | D1 = 192:D2 = 65:D3 = 4:D4 = 2749:GOSUB 9000 |
| 14820 | D1 = 0:D2 = 0:D3 = 3:D4 = 2554:GOSUB 9000 |
| 14825 | POKE—3263,A:POKE—3262,A:POKE—3200,A5:POKE—3195,A |
| 14830 | POKE—3136,A2:POKE—3072,A:POKE—2943,A2:POKE—2879,A2 |
| 14835 | POKE—2874,A:POKE—2810,A:POKE—2809,A:POKE—2750,A2 |
| 14840 | POKE—2744,A:POKE—2685,A8:POKE—2679,A:POKE—2620,B1 |
| 14845 | POKE—2555,B1:POKE—2490,A8:POKE—2489,A8:POKE—2488,A8 |
| 14850 | POKE—2487,A:POKE—2815,B1 |
| 14895 | RETURN |
| 14900 | REM ALASKA |
| 14905 | POKE—2361,A |
| 14995 | RETURN |
| 15000 | REM HAWAII |
| 15005 | POKE—2233,A |
| 15095 | RETURN |

Chess Machine Survey



There has been a great deal of discussion recently about the value of the chess programs available for microcomputers. Although many chess machines have been reviewed in magazines, few critics have been competent chess players and the machines have been assessed in terms of technical merit or by being played against each other at low levels; alternatively, international masters — who can beat the machines easily at any level — have been called on to endorse the programs. J F White redresses the balance as one who can play the machines at their own level.

MY OWN interest in chess machines dates back to the days of mainframe programs. Although I am a reasonably strong club player, I prefer opponents who are always ready when I am, and can be switched off when the position becomes difficult. I have tried to keep up with all the new machines as they are marketed.

Historically, the original purpose for programming a computer to play chess was to provide an insight into the working of the human brain, to mimic the means by which a human assessed a complex, analysable situation.

The first programs were written for mainframe computers — the chip was not available — and I can still recall an international game between the best Soviet program and the best U.S. one.

As you might expect, the U.S.S.R. has taken a particularly keen interest in chess programming a computer to play chess was master has said that its players are almost computerised already.

Rapid developments

The Soviet machine won, but the standard of play was so poor that a novice might have done better. Developments in both programming and technology followed rapidly, although not so fast that English master David Levy was to lose his bet, placed in the late 1960s, that there would be no machine program capable of beating him within 10 years.

Nevertheless, by 1975, machine programs had been developed which could beat many human opponents, as was demonstrated in a tournament in the U.S. that year. The present generation of chess machines is capable of giving any competent chess player a good run for his money, and it was the advent of the chip which brought those programs into the home.

Characteristic method

The first machine on the U.K. market was Boris which altered its level of play by setting a clock — the longer the time of thinking, the longer the ply search and the greater the depth of thinking.

Boris was introduced in 1978. In March of the same year, Dan and Kathe Spracklen in the U.S. invented the Sargon program in Z-80 assembly code. It won the 1978 U.S. championships for microcomputers.

Sargon has a characteristic method of play, and has been developed and used in subsequent chess machines. The Chess Challenger series has a style of play similar to that of Sargon.

Features of Sargon and Chess Challenger are an obsession with doubling-up the opponent's pawns and avoiding doubling its own, moving the queen into a better position behind its pawns and advancing passed pawns.

The strategy of the chess programs has been to award points for winning the

opponent's material, for defending its own, and for controlling or defending the squares of the board, especially at the centre.

According to the level of play, the program thinks about an increasing number of responses to its move, i.e., if I do this, the human will do that, so I shall move another, and so on, but the huge number of possible moves in chess makes pre-selection of some moves essential and they are analysed in greater depth — the so-called ply search.

It is very hard for a program to see that if, instead of taking a rook now — win of many points — it sacrifices three pawns in succession — loss of points — it will win the opposing queen.

Complex analysis

To see the winning of the queen would require analysis of the moves of some $(32)^4 \sim 1$ million pieces — assuming all 32 pieces remain on the board — whereas an early selection of the best ply move, which would require much less memory, would rule out the loss of pawns in favour of the acquisition of a rook.

A greater problem is the assessment of a position, and even the best present programs tend to become poorer in the end-game. I have seen a machine advance a pawn steadily onwards, straight towards the opponent's waiting king.

It could not see far enough ahead to

realise that the king could take it while advancement of a pawn scored high priority in its general program.

Nevertheless, a remarkable feature of the best programs is that they give a good game at all the higher levels — increasing the time spent at a level, or the depth of search at that level, is subject to the law of diminishing returns owing to the increasing number of possibilities which have to be considered, or owing to the wrong selection of a ply search in the first place.

Better positions

The result of the program's calculations is that it keeps moving pieces into what it regards as better positions. Although capable of executing simple combination moves, even the best programs are as yet incapable of forming long-term plans.

That means the better machines are superb at defending, where no plan is generally needed, but much poorer when attacking as well as in the end-game.

Contrary to widespread reports, the better machines do not have an obsession with attack, although it is a feature of the simpler programs with their lesser emphasis on positional points. Because the machines cannot form a plan, the motive for every move can always be seen by a little inspection.

It must, therefore, be emphasised that the machine cannot beat you in the sense that a human opponent can — you beat yourself by overlooking an obvious move by the machine.

That is not to deny that the machines have any useful purpose, since they greatly improve the precision of your play by forcing you to study all its possible moves.

Unlike a human opponent, the machine cannot overlook anything. In the complicated middle of a game, the machine can calculate better than a human who should aim to win by adoption of a plan or by positional play, rather than simply by trying to secure superior exchanges of material.

Sophisticated graphics

Of the present machines, on cassette for use on microcomputers, we have Microchess and Sargon chess. The former can be used with 6502 or Z-80 CPUs, but has been severely criticised recently for its fixed response to moves and its poor level of play. It is suitable for beginners only.

The Sargon chess program is available only for machines with Z-80 CPUs. It combines six levels of play with sophisticated graphics which suffer from the problem of putting black and white pieces on black and white squares, giving a confusing mixture of types to surmount the problem.

There are no book openings pre-programmed but the level of play is good. I should estimate that the play is about equivalent to that of a Chess Challenger 7

at the corresponding first three levels, but the response time is slower — level two takes an average of one to two minutes; level three, which considers three consecutive moves, is worse, and level six is excruciating.

Remarkably, the original program uses only 8K of memory, and will run, for example, in a TRS-80 16K Level II. The cassette costs about £16, although a newer version, winner of the 1979 championship, is available for £28.

With hardware, as far as the chess machines go, it may be said that you get broadly what you pay for. In the lower range, is Videomaster Chess Champion, £55 — at present only £35 from Comet — and Commodore Chessmate — about £50. They are suited best to beginners, being considerably weaker than the Chess Challenger 7.

The Chess Challenger series, 7 — seven levels — 10 — 10 levels — and Voice — 10 levels — respectively £100, £160 now discontinued, and £250, are all closely related, the first two being based on a Z-80 microprocessor and the Voice on a Z-80A.

The Voice is, therefore, about twice as fast as the others, and the program has been slightly improved. The Voice can speak all its own moves and your responses, which is helpful for the blind, but can otherwise be very irritating.

A measure of the power of the Voice is its 96K ROM and 8K RAM, excluding that dedicated to the voice, which would put it out of the reach of most microcomputers even if it were available on cassette. The standard of play of the Chess Challenger 7 and Voice is very good.

Tournament standards

Tournaments against human players have put their standard, at the highest level, at about that of the average-to-good club player. Even international master Hartston, known to readers from the BBC *Master Game*, referred to the Voice as "a very good toy" at its launch in 1979.

The Challenger is pre-programmed with several book opening moves and it is also possible to establish your own position and watch the machine react.

In addition, like all the better chess machines, there is a random facility enabling the program to choose its own response from several of roughly equal value. That makes each game different. Even the lowest level is superior to Microchess, and I greatly enjoy games of lightning chess against it — each move to be made within 10 seconds.

Unfortunately, at the higher levels, the response time becomes increasingly slow. On the Chess Challenger 7, at level six — best play, average response time, six minutes — it can take an enthusiasm-destroying 30 minutes for one move in a complicated position. The machine varies its response time according to the complexity of the situation.

A typical game at that level can take five to seven hours, including the one hour spent by the human: it is difficult for the latter to concentrate for that length of time and lapses of concentration are punished heavily.

Infuriatingly, after all that time, the Voice reminds you at short intervals to "make your move" in a Dalek-like voice, which would not be allowed in a human game and is a strong inducement to turn the speaker off, thereby wasting the extra money which you have spent on the feature.

This year more chess machines have been launched. A new Chess Champion, £155, is reputed to be superior to any of the previous machines except the Challenger series, and has the added attraction of a chess-board display, £107, and a print-out of the game, £105, as optional extras.

Response times

The other is the Sargon 2.5, £280, manufactured by the maker of the pioneering Boris — now withdrawn after heavy criticism of its high price, £180, and comparatively poor play — and available as a cartridge which can be removed and replaced for a superior version at a later date without replacing the hardware.

The level of play of Sargon 2.5 is superior to that of the similarly-priced Voice but is without the ability to speak. It is much faster — average response time at the top playing level is two minutes.

Sargon 2.5 will probably stretch the ability of all club players at that level. It has a random choice of moves and can store positions for long periods — useful if the game has to be interrupted.

The most recent arrival on the chess computer stage from Hong Kong, the Super System III, is available with every conceivable user facility. As well as the basic chess computer at £155, it is also possible to buy a computer-operated board on which the pieces are displayed, £107, and a printer which can be used to list the moves shown on the board to give a permanent record, £105.

In addition, further options include a memory pack which will hold an uncompleted game for up to a year and a battery pack for travelling.

Fixed-period moves

Super System III is claimed to be the first machine available on the domestic market which obeys all the rules of chess. It recognises a stalemate after repetition of three positions or after completing 50 moves without a piece being taken or a pawn moved, as well as castling, *en passant* and promotion of a pawn — which is not automatically to a queen; you are offered the choice if the pawn promoted is yours.

It differs from Sargon and Chess Challenger in that the moves are made after a fixed period of time, which can be

(continued on next page)

(continued from previous page)

set between zero seconds and 99 hours.

The advantage is that it is possible to tell exactly when the machine will make its move, avoiding the frustration of waiting up to half an hour for a move supposed to take an average time of six minutes with other machines. The disadvantage is that the machine may need to show its best move when the time is up without having completed its ply analysis.

Random choice

The memory of the Super System III consists of 8K ROM and 1K RAM, inviting comparisons with the early Sargon program. At longer response times, i.e., around 10 minutes, the designers claim that the level of play is equal to that of the Voice Challenger. In some respects, though, its play at lower response times seems to be poorer.

As far as I can tell, no book-openings have been pre-programmed and the manual makes no mention of the machine possessing a random choice between moves of equal value. I have not been able to play it often enough to tell whether identical opening moves are always met with by identical responses.

Compare the following plays to Super System III at response of one minute and Chess Challenger 7 at level two — average response time 15 seconds — the CC7 was first adjusted to overcome the pre-programmed book opening:

| | White (Author) | Black SSIII | Black CC7 |
|---|-------------------|----------------|--------------|
| 1 | d2-d4 | d7-d5 | d7-d5 |
| 2 | c2-c4 | d5xc4 | d5xc4 |
| 3 | e2-e4 | g8-f6 | g8-f6 |
| 4 | b1-c3 | b8-c6 | b8-c6 |
| 5 | e4-e5 | c8-g4 ?? | f6-g4 |
| 6 | f2-f3 | g4-e6 | — |
| 7 | e5xf6 | d8xd4 | — |
| 8 | d1xd4 | c6xd4 | — |

Within seven moves, the Super System III has managed to lose a knight with little compensation, although my next few moves were rather difficult. The Chess Challenger 7 avoided the trap.

Much has been said of the game between the world champion Karpov and a Super System III in West Germany. Karpov was a rook down and should have lost, but the machine made a frightful blunder which enabled Karpov to give checkmate — the Chess Challenger 7 finds the correct move at all levels, including the lowest.

Simultaneous exhibition

Unfortunately, it seems clear from an analysis of the game that Karpov's earlier loss of the rook was due to a blunder of his own, when under no pressure, and not to any brilliance by the machine.

Karpov was one of several grandmasters giving a simultaneous exhibition against 25 Super System IIIs each, so that the Super System III had plenty of chances of securing at least a win — all of which it missed as have all the other chess

computers available on the domestic market.

Two new chess games have just been announced by Optim Games. The first, called Intelligent Chess, was designed with the aid of Davy Levy and has a built-in tape recorder allowing it to replay games on a colour television. It will retail at about £295. The company intends to release another, less sophisticated chess game early in the autumn for £39.95.

Conclusions

● All-in-all, the Super System III is a competent machine with many fascinating extras — the perfect gift for the man who has everything.

● In terms of pure chess-playing ability, though, the main unit may not perhaps be such good value as the Chess Challenger 7 and Sargon 2.5.

● Addition of the LCD board and the printer obviously reduces the value for money for a chess purist who does not mind moving pieces and writing down his own moves.

● Computer, board and printer are available for £370, which includes an attache case to carry the units.

● For a serious chess player who can afford it, Sargon 2.5, £280, is a must.

● Chess Challenger 7, £100, is also fine value for money, albeit slower and weaker than Sargon.

● If you have a Z-80-based micro-computer with 16K user RAM, the Sargon cassette, £16, seems a good buy. □





L & J COMPUTERS

3 CRUNDALE AVENUE, KINGSBURY NW9 9PJ 01-204 7525

THE "PET" SPECIALISTS



| | | | | | | | | | | | | | | | | | | | | | | | |
|--|---------------------|-------------------------------------|------|-----------------------------|------|------|--------------------------------|------|----------------------------|------|----------------------|-------|----------------------|----------|----------|----------|----------|------------|---------------|------------|------------|------------|---|
| <p>NEW LOW, LOW, 'PET' PRICES!!</p> <table style="width: 100%; border-collapse: collapse;"> <tr> <td style="padding: 2px;">Pet 8K (Large keys)</td> <td style="text-align: right; padding: 2px;">£420</td> </tr> <tr> <td style="padding: 2px;">16K</td> <td style="text-align: right; padding: 2px;">£499</td> </tr> <tr> <td style="padding: 2px;">32K</td> <td style="text-align: right; padding: 2px;">£630</td> </tr> <tr> <td style="padding: 2px;">Ext cassette decks (+ counter)</td> <td style="text-align: right; padding: 2px;">£ 55</td> </tr> <tr> <td style="padding: 2px;">PET Friction Feed printers</td> <td style="text-align: right; padding: 2px;">£350</td> </tr> <tr> <td style="padding: 2px;">AVAILABLE FROM STOCK</td> <td style="text-align: right; padding: 2px;">+ VAT</td> </tr> <tr> <td style="padding: 2px;">Printers/Disc Drives</td> <td style="text-align: right; padding: 2px;">Sundries</td> </tr> <tr> <td style="padding: 2px;">PET 3023</td> <td style="padding: 2px;">PET 3040</td> </tr> <tr> <td style="padding: 2px;">PET 3022</td> <td style="padding: 2px;">Compu 400K</td> </tr> <tr> <td style="padding: 2px;">Centronic 779</td> <td style="padding: 2px;">Compu 800K</td> </tr> <tr> <td style="padding: 2px;">Spinwriter</td> <td style="padding: 2px;">Interfaces</td> </tr> </table> <p style="font-size: 0.8em; margin-top: 5px;">Tool kits: library cases Disks: C12 Cassettes Paper (roll & tractor feed) Labels: Dust covers</p> | Pet 8K (Large keys) | £420 | 16K | £499 | 32K | £630 | Ext cassette decks (+ counter) | £ 55 | PET Friction Feed printers | £350 | AVAILABLE FROM STOCK | + VAT | Printers/Disc Drives | Sundries | PET 3023 | PET 3040 | PET 3022 | Compu 400K | Centronic 779 | Compu 800K | Spinwriter | Interfaces | <p>SOFTWARE</p> <p>As well as a full range of Petsoft and Commodore Software, we have some highly reliable "Home-Brewed" programs available.</p> <p>STOCK CONTROL & INVOICING £60 (Handles up to 500 items — 32K) (180 on 16K). Stock depleted on invoicing, search etc. Cassette, disk (& print option).</p> <p>STOCK TAKING £230 Basic program which can be tailored to suit most trades. Beautiful print-out!</p> <p>OUTSIDE SERVICES (For Mini-Cabs Etc) £220 Weekly or monthly invoices — cheque writing facility — optional deductions. (16 or 32K + disk + printer).</p> <p>MACHINE HIRE £420 Covers hiring of machines, customers, due & overdue. Hiring Charges: Machine History: Printouts for all Sections. Ideal for Typewriter & Plant Hire Firms.</p> <p>CASH BOOK £90 Enter daily/weekly amounts — printout and totals, weekly/monthly analysis, totals and balances.</p> <p style="font-size: 0.8em; margin-top: 5px;">See for free software booklet</p> |
| Pet 8K (Large keys) | £420 | | | | | | | | | | | | | | | | | | | | | | |
| 16K | £499 | | | | | | | | | | | | | | | | | | | | | | |
| 32K | £630 | | | | | | | | | | | | | | | | | | | | | | |
| Ext cassette decks (+ counter) | £ 55 | | | | | | | | | | | | | | | | | | | | | | |
| PET Friction Feed printers | £350 | | | | | | | | | | | | | | | | | | | | | | |
| AVAILABLE FROM STOCK | + VAT | | | | | | | | | | | | | | | | | | | | | | |
| Printers/Disc Drives | Sundries | | | | | | | | | | | | | | | | | | | | | | |
| PET 3023 | PET 3040 | | | | | | | | | | | | | | | | | | | | | | |
| PET 3022 | Compu 400K | | | | | | | | | | | | | | | | | | | | | | |
| Centronic 779 | Compu 800K | | | | | | | | | | | | | | | | | | | | | | |
| Spinwriter | Interfaces | | | | | | | | | | | | | | | | | | | | | | |
| <p>WE ARE NOW TAKING ORDERS FOR THE NEW 8000 SERIES CBM'S FOR AUGUST DELIVERY</p> <table style="width: 100%; border-collapse: collapse;"> <tr> <td style="padding: 2px;">8032 (80 col. screen: new keyboard)</td> <td style="text-align: right; padding: 2px;">£895</td> </tr> <tr> <td style="padding: 2px;">8050 (974 K/Bytes: new DOS)</td> <td style="text-align: right; padding: 2px;">£895</td> </tr> </table> <p style="font-size: 0.8em; margin-top: 5px;">(see for details: Demonstrations NOW)</p> | | 8032 (80 col. screen: new keyboard) | £895 | 8050 (974 K/Bytes: new DOS) | £895 | | | | | | | | | | | | | | | | | | |
| 8032 (80 col. screen: new keyboard) | £895 | | | | | | | | | | | | | | | | | | | | | | |
| 8050 (974 K/Bytes: new DOS) | £895 | | | | | | | | | | | | | | | | | | | | | | |
| <div style="display: flex; align-items: center;">  <div style="margin-left: 10px;"> <p>COMPLETE SYSTEMS FROM £1700!!</p> </div> </div> <p style="font-size: 0.8em; margin-top: 5px;">THE SYSTEMS WE SUPPLY & INSTALL ARE COMPLETE: ESTIMATES GIVEN FREE WITH NO HIDDEN EXTRAS: FULL BACK-UP: GUARANTEED EXPERTISE.</p> <p style="font-size: 0.8em; margin-top: 5px;">PRICES DO NOT INCLUDE VAT</p> | | | | | | | | | | | | | | | | | | | | | | | |
| <p style="font-size: 0.8em; margin: 0;">PERSONAL SHOPPERS WELCOME Phone & Mail Orders accepted.</p> <p style="font-size: 0.8em; margin: 0; text-align: right;">ALL GOODS SENT SAME DAY WHEREVER POSSIBLE LARGE S.A.E. FOR LISTS ETC.</p> <div style="text-align: right; margin-top: 5px;">   </div> | | | | | | | | | | | | | | | | | | | | | | | |

• Circle No. 168

Da Vinci Computer Shop

65, High Street, Edgware, Middx HA8 7DD.

Open

Mon-Fri 9-5:30

Sat 9:30-5:30

Tel 01-952 0526



NEW PRICE PETS

CBM 32K £695.00
CBM 3040 FLOPPY £695.00
CBM 3022 PRINTER £425.00

SALES/PURCHASE -
LEDGER ACCOUNTING
INCOMPLETE RECORDS

NEW 80 COLUMN
SCREEN PET
£895.00

WORD PROCESSING,
INVOICING - PAYROLL

NEW 1MEG DISC
DRIVE £895.00

STOCK CONTROL
INFORMATION RETRIEVAL

QUME SPRINTS
DAISY PRINTER
£2115.00



OUR SYSTEMS ARE MASTERPIECES - COME AND SEE THEM!

• Circle No. 169

Now!

Typewriter Quality Printing



on your
microcomputer for
£ 960 +VAT
or Easy Terms

The CPS 3982 is a fully re-conditioned IBM 3982 'golf ball' printer with special CPS electronics designed for use with your microcomputer.

90 day warranty and nationwide maintenance service agreement available.

Features

- Interchangeable golf ball print head (mathematical font available)
- 132 print positions
- Serial port 110 Baud via 25 way 'D' socket (RS 232 type)

Options:-

- Pin feed platen
- PET IEEE interface
- APPLE Serial interface card

For more information and easy terms facilities
phone 021-707 3866 Telex 312280 CPS G



CPS (DATA SYSTEMS) LTD

Arden House, 1102 Warwick Road,
Acocks Green, Birmingham B27 6BH

CPS are PET and APPLE Dealers

• Circle No. 170

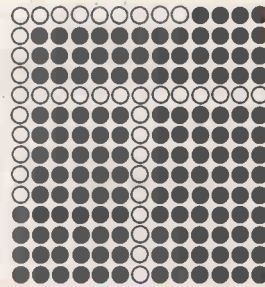

HUGE SAVINGS ON EX DEMONSTRATION STOCK

- * Video Display Units
- * Matrix Printers
- * Daisy Wheel Printers
- * Line Printers

PHONE 0383 823121
and ask for peripheral products.

Service depots in Scotland & England.

FORTRONIC

for all your computer peripherals.

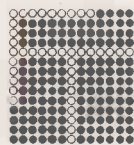

Fortronic Ltd, Holden Way,
Donibristle Industrial Estate,
Dunfermline.

Tel 0383 823121 Telex No 727438

Distributors for Tally, V.C., Facet/Qume.

Available ex stock.

Also distributors for Wang.

• Circle No. 171

Junior Minister outlines plans for computing in schools

As Parliamentary Under-Secretary at the Department of Education and Science, Neil Macfarlane is closely involved with Government plans to promote the use of microcomputers in schools. In this interview with Paul Fisher, the Junior Minister explains how the Government sees those plans developing.

PF: *How high a priority does the Government give to computer education at secondary and primary level?*

NM: It gives a high priority to the increasing awareness of those facilities as appropriate within the limits of public expenditure. There is obviously a limiting factor within most western economies at the moment and ours is no different. The general thrust of Government economic strategy is well known so it is not surprising that we are having to watch our pennies at the Department of Education and Science.

However, one has to understand that many local authorities have been pursuing their own programmes for a general computer education for a number of years. At the same time, one has to acknowledge that the Department of Industry and its education unit have also provided additional back-up.

The increase in our activities in microelectronics, the formation of our advisory group and the £9 million to be spent over the next four years is, we hope, putting some cream nearer the top.

PF: *Are you satisfied that enough money is being spent?*

NM: Within the limits of public expenditure, yes, I am. The local authorities have already spent several million pounds. I'm very encouraged by what I've seen over the past 12 months and am most impressed by the degree of expertise which exists in many local authorities.

We are now trying to organise an infinitely closer relationship between the worlds of industry and education, starting with our regional conferences later this year. We are having 10 such conferences which will cover all 105 local authorities. We've latched into local industry and the links we are fostering will obviously involve a good

deal of microelectronics activity. I hope the pace of change over the next few years will be well understood by schools and that industry will march a long way towards helping them. It is now up to the Department of Education and Science to provide co-ordination throughout the country and to monitor what is happening through the director.

We're not doing badly in this country and we hope that by adding the £9 million we shall really be ahead of the field so far as western Europe is concerned.

PF: *Do you have any figures for how much is being spent overall on computing in secondary education?*

NM: No, I don't. Most polytechnics have 30 or 40 micros and the majority of further education colleges have two or three. In the university sector, the current costs are met by the Computer Board which last year spent some £13 million on equipment and £20 million on recurrent costs.

So far as schools are concerned, we would not really have a detailed and accurate figure. Some local education authorities are spending a considerable amount. We hope that over the next year or so our microelectronics advisory group and the director will have a greater awareness of what is being spent.

PF: *Could you tell me about this advisory group?*

NM: It had its first meeting on Friday, July 25 and was chaired by one of our Under-Secretaries, Mr Halsey. It includes those who have had experience in teaching both in the private and the maintained sectors of education. We've Mr Coll of Oundle School, Mr Clements of King Edward Fiveways, Mr Esterson from the Inner London Education Authority, Mrs Fraser from the College of St Mark and St John and Mr Fairbairn of the National Computing Centre.

Since joining Parliament in 1974, Neil Macfarlane has sat on the Select Committee on Science and Technology, was a member of the sub-committee assessing science and technology in Japan and has held his present position since 1979.



Then there are the departmental members from the Inspectorate, Mr Mann of the Schools Council and of course our friends from the Council for Educational Technology and the Department of Industry. It will meet six times a year and, along with the full-time director, will be a good focal point for all local education authorities.

Baroness Young and myself will obviously take a very close interest in the work of this committee but we shall all largely be in the hands of the director. While we shall be considering the importance of equipment, the day-to-day points will be in the hands of the director.

PF: *So, if there is any attempt to standardise equipment, that will be decided by the director?*

NM: Yes. That's a difficult one because so many have got so far down the road and have their own programmes lined-up for the next few years. I think that the biggest difficulty will be in persuading members of staff who haven't had a hand in computing to teach themselves so that they understand it.

PF: *Do you see a role for some kind of guru? I'm thinking of a person who knows a good deal and could administer a software library and answer specific technical questions.*

NM: I don't think so.

PF: *Has any of the £9 million been spent yet?*

NM: No, it hasn't, but as I said, money is constantly being spent by the local authorities. We are now in a position to really take off in the next year or so and I hope that the local authorities will keep that momentum going because it is important even in these days of restricted public expenditure.

PF: *Why was it decided not to spend any of the £9 million on hardware?*

NM: In many cases, the purchasing of hardware has already been completed. What could well prove an important exception is that some of the programme's resources could be devoted to work in special educational fields.

Little electronic equipment has been designed for children with special educational needs. I think that at the moment, while we have announced the money, it is up to the experts, the director and his

committee, to determine how that money is spent.

PF: *How important are competitions?*

NM: They are not an important part of the Department of Education and Science approach but they certainly are so far as private enterprise and, to a lesser extent, the Department of Industry. Our responsibility is to ensure that there is equal coverage and that all local education authorities have a share of the cake.

PF: *What do you think of the French approach of installing a micro-computer in every school?*

NM: I went over there for three days at the end of March and I saw the French Science Minister and visited their centre just outside Paris. At the moment, their scheme to distribute 40,000 microcomputers is at an embryonic stage. The time to look will be early next year.

The French education system and our own are totally different. Theirs is controlled from the centre by government. Here, we work through the local education authorities. We are a policy department rather than an executive department, so it is very difficult to compare.

PF: *Is there to be any significant change in the central Government role in the administration of a microelectronics programme?*

NM: So far as the Department of Education and Science is concerned, no. The role of the local authority, as enshrined in the 1944 Act, is the authority for that area. While this department can provide further top-up and back-up, it certainly would not be for it to dictate to a local authority what equipment it should purchase and how a particular course should be taught.

PF: *What kind of computer skills do you think should be promoted in schools?*

NM: Well, I think that the real importance of computer studies is that they are a fundamental mind-training activity and that they also have to be useful to most pupils in their adult lives.

Even if you have a competent mathematician, that person may not necessarily have a total flair for handling and working with computers.

I think that what many people

will be looking for is a certain flair in a person to understand just how these skills have been developed.

PF: *So you don't see computer studies related to any particular subject?*

NM: Well, not essentially. I think that our microelectronics programme will concentrate on business studies, craft design technology as well as mathematics and the sciences. Certainly, the skills applications thereafter will be determined largely by a person's flair in this field.

Some months ago, when I was talking to a businessman, he said he wished his son had been taught typing at school because he thought it would have helped him. I am not going to pass judgment on that except to say that I think if anybody wants to learn typing, they don't necessarily need to expect the school to teach it to them. They can do it by buying an old typewriter and learning it in their spare time.

PF: *So, how important do you think it is that children have a chance to use a computer?*

NM: I think it is very important, even in the latter stage of primary education. I would suggest that a general awareness of what can be done is essential from about the age of 10 or 11.

PF: *It seems remarkable to some people amid all the other cuts, one of the things which is being favoured is microelectronics.*

NM: Yes, I think it is. There has been the announcement of the money to Inmos and the fact that over the last year, and during the next few years, the Science Research Council budget has been held. The Science Research Council is involved in computer science so we reckon that by 1983/4, the expenditure will be some five per cent above what it was in 1978/9. Some four or five years ago, when I was a member of the Select Committee on Science and Technology, I was taken to a valley in California and told that this new substance was going to revolutionise our work and lifestyle. I found that there were five Britons working on that project. I just wish somehow we could have kept them in this country.

PF: *Perhaps Inmos will grab them back?*

NM: I think that is a distinct possibility. M

Making Tuscan communicate with the outside world

This month, Mike Hughes discusses the design of the Transam Tuscan input/output circuitry — the eyes, nose, ears and mouth of the system.

PUTTING memory into a computer presents no problems whatsoever. It is only necessary to decode — from the high-order address lines — chip select signals which tie in with the organisation of memory within the chips.

The low-address lines are paralleled to all the memory chips to select the required byte of memory and the chip-select line activates only the chip in question — figure 1.

General method

Random access memory, RAM, and read only memory, ROM or EPROM, are managed in near identical ways — the only differences is that RAM requires two strobe lines, memory read and memory write, to differentiate between the two complementary operations while ROM needs only a memory-read strobe — for obvious reasons.

I had already devised a general method to isolate the on-board system with data buffers from the S-100 busbar so it required very little design effort to arrange the protocol of address lines and chip selects for memory within the on-board system.

The only problem I would face was the actual lay-out of the reasonably large number of chips — we had decided to use type 2114, 1K by four bit, chips for the RAM and type 2516, 2K by eight bits, chips for the on-board EPROM. To provide 8K of each required 16 of the 2514s and four 2516s.

The part of the system which still required thought was the I/O circuitry. Probably because I am more interested in hardware than software, I always find I/O systems the most rewarding parts of a computer to design. Once one has designed the fundamental system, they are also quite easy to understand and handle.

While memory is akin to the computer's brain, the input/output system equates to its eyes, nose, ears and mouth and is used to communicate with the outside world.

Required versatility

From the outset, we had decided that Tuscan should have a high degree of I/O facility on its main board to give it the versatility we envisaged end-users would require. Obviously, we had to make provision for communication with the system and, therefore, had to allow for

keyboard entry and a means for the system to talk back — through a video display unit.

That would be the bare minimum for someone who wanted a single-board home computer but clearly, we had to go some way further to provide a means of saving programs on tape. That would require a means of serialising data — converting it from 8-bit parallel bytes to a series of pulses down a single line — and converting it by modulation into a form which may be recorded on audio tape.

To complement that, one would also need a system to receive data played back from tape, demodulate it into a series of pulses and then re-form it back into parallel 8-bit data to go back into the computer.

Transam had also specified an RS232 serial I/O option for use with an external terminal or with serial input printers. RS232 is simply a standard for serial transmission of data and specifies that the logic levels should be represented by voltage swings between +12V and -12V — as opposed to the more common logic levels of +5V and 0V.

The RS232 interface would require parallel-to-serial and serial-to-parallel converters for the output and input respectively, together with a level converter to change TTL levels to RS232 standard and an interface to convert RS232 back to TTL levels.

Port address

The Z-80, like the 8080, allows up to 256 input and output ports which can be addressed independently. The address of a port is carried on the bottom eight bits of the address busbar and, because I had modified the Z-80 address busbar to simulate an 8080, the I/O port address on Tuscan is duplicated on the top eight bits.

By and large, an output port consists of a single or set of up to eight latches which take, as their input, the signals on the internal data busbar. The gating of those signals into the latches is arranged to occur only when that particular port is addressed and when the I/O write strobe of the control bus is active.

Sometimes the set of latches can be disguised within a specialised circuit which performs other functions, for example, a serialiser. The outputs of the latches take up the condition of the inputs at the time of the I/O write strobe and hold the data stable until such time as it is changed by a further output operation. While the data is stable on the outputs, the outside world

Figure 1. High-order address lines decode individual chip signals while low-order lines are used to address locations within the chip.

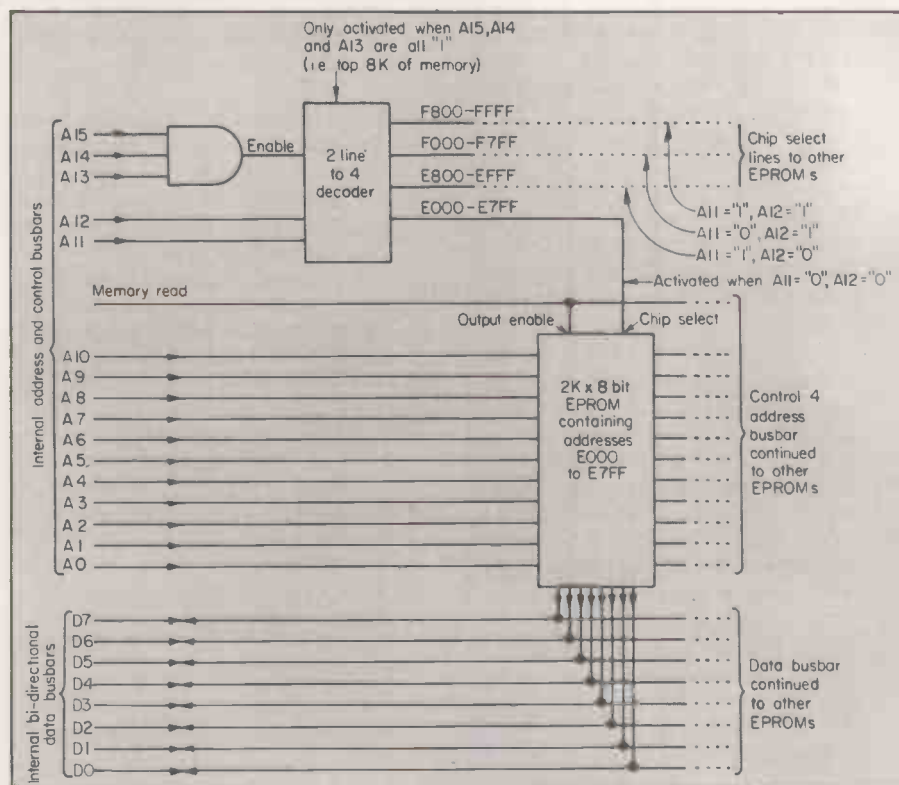

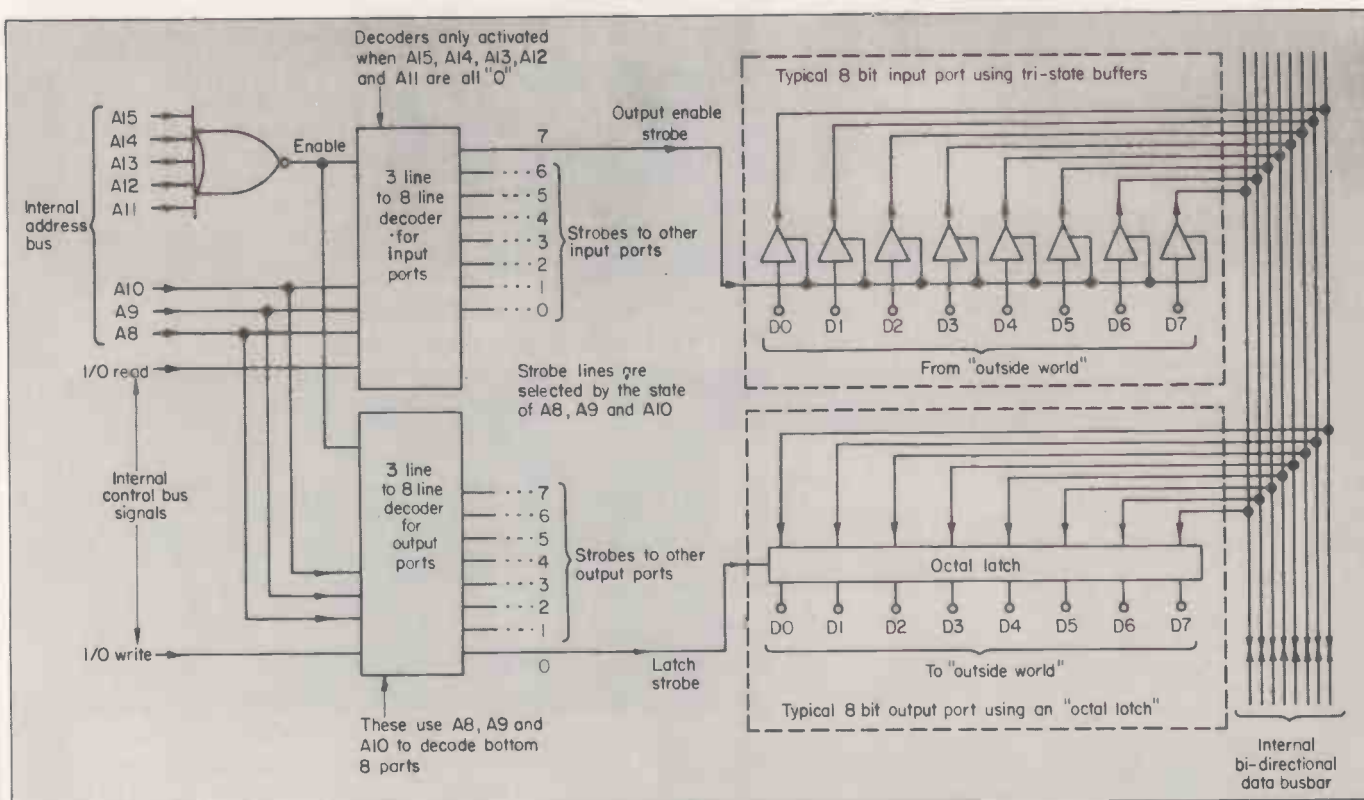

Figure 2. Input and output ports often take this form but there are many variations and the latches and buffers might be contained within a multi-function IC, e.g., a UART.

can use it as a steady source of information.

An input port, on the other hand, is usually a set of tri-state buffers — sometimes tri-state latches — feeding into the internal data busbar. The outside world can place data on the inputs to the buffers but their outputs are held in a tri-state condition — ensuring that they do not influence the data busbar until the port is addressed and an I/O Read strobe is generated on the control busbar.

In some respects, I/O ports resemble memory elements which can be written to or read from; they differ only in that there are not so many of them and that they convey information to and from the outside world.

Many types of microprocessor, unlike the Z-80 or 8080, require one to use certain reserved memory addresses to designate I/O ports — this fact underlines the similarity in operation.

On-board system

By chance, the way I had decided to identify addresses of the on-board system, to control the on-board data buffers, made the on-board system respond not only to the top and bottom 8K of memory but also the bottom eight I/O ports — eight input and eight output. I would require one input port to handle the keyboard and one output port to control the on-board VDU.

To serialise data for the tape, or communications, modulator/demodulator (Modem), it was most cost-effective to use a UART (Universal Asynchronous Receiver Transmitter).

A UART contains an output port to feed the serialiser and an input port to obtain data back from the serial to parallel converter. It also contains a second input port which provides data which describes the current status of the UART — whether it is ready to transmit, whether it has received data or whether any error conditions such as parity or framing errors exist. I would need a second UART to handle the RS232 interface and it would have the same three types of ports as the Modem serialiser.

So far, the number of ports required totted up to five input and three output and I had provision within my block of addresses for a further three input and five output ports. It seemed a shame not to make use of them.

Further discussion revealed the need for a spare 8-bit parallel output port to be used as a possible interface to parallel input printers of the Centronics type. It might need a strobe associated with it which could be produced by another single-bit output port.

For good measure, we decided to put that in and, at the same time, use the remaining three output ports as single-bit ports for general-purpose applications. They might be for switching relays in control applications or to output waveforms — music and the like.

By this time, Brendan Owen had been getting on well with the development of some monitor firmware for the machine but had run up against a self-inflicted problem. We had conceived Tuscan with so much system flexibility in mind — on-board VDU; S-100 memory-mapped

VDU, internal keyboard, external terminal operation, Centronics or RS232 printer options and 2MHz or 4MHz clocks that he did not know which system the monitor ought to be designed to cope with.

As we had 2K of EPROM available for that monitor, we thought it might just be feasible to cope with all the options at the user's discretion and to do that, Owen wanted a four-bit input port which could have data set-up on it by means of a set of switches. That would define the system configuration.

General purpose

Early on in the system's initialisation, the monitor would look at this switch and configure itself to the system set-up by the user. It seemed a good idea anyway. That left two spare input ports which we decided to make general-purpose single-bit ports to be used for handshaking operations or to convey control data back into the computer from any external process-control operations.

Producing the 16-port select signals presented no difficulty and utilised only two chips — figure 2. They were both to be 74LS138s — three to eight line-decoders with two enabling inputs. The master signal, which identifies when the bottom eight ports are being addressed, already existed in my on-board system address circuit and could be used to feed one of the enabling inputs of each of the decoder chips.

The second enabling input of each could be fed by I/O read and I/O write

(continued on page 85)

**EUROPE'S LARGEST SELECTION OF MICROCOMPUTER BOOKS, MAGAZINES AND SOFTWARE FOR
THE HOBBYIST, EDUCATIONALIST, PROFESSIONAL AND RETAILER**

FOR THE NOVICE

| | |
|---|--------|
| From the Counter to the Bottom Line | £10.00 |
| Your Home Computer | £ 5.95 |
| Introduction to Personal and Business Computing | £ 4.95 |
| Getting Involved with Your Own Computer | £ 4.75 |
| How to Profit from Your Personal Computer | £ 5.50 |
| Microcomputer Potpourri | £ 2.40 |
| Hobby Computers are Here | £ 3.95 |
| New Hobby Computers | £ 3.95 |
| Understanding Microcomputers and Small Computer Systems | £ 6.75 |
| Understanding Microcomputers and Small Computer Systems and Audio Cassette | £ 8.75 |

FOR FUN

| | |
|--|--------|
| SARGON — A Chess Game | £ 9.50 |
| BASIC Computer Games | £ 5.00 |
| More BASIC Computer Games | £ 5.50 |
| What to do After you Hit Return | £ 8.95 |
| 8080 Galaxy Game | £ 6.95 |
| SUPER—WUMPUS — A game in 6800 Assembler & BASIC | £ 4.25 |
| Computer Music Book | £ 6.75 |
| Computer Rage (A board game) | £ 6.95 |
| Artist and Computer | £ 3.95 |
| Games, Tricks and Puzzles for a Hand Calculator | £ 2.49 |
| Introduction to TRS-80 Graphics | £ 5.75 |
| Take My Computer Please... (Fiction) | £ 3.25 |
| Introduction to Low Resolution Graphics | £ 5.50 |

CONCERNING LANGUAGE

| | |
|---|--------|
| SCALBAL — High Level Language Plus Supplements | £15.00 |
| Instant BASIC | £ 6.95 |
| Basic BASIC | £ 6.50 |
| Advanced BASIC | £ 6.00 |
| Users Guide to North Star BASIC | £10.00 |
| A Practical Introduction to PASCAL | £ 3.95 |
| Microsoft BASIC | £ 6.50 |

FOR THE 6502

| | |
|--|--------|
| 32 BASIC Programs for the PET | £10.00 |
| 6502 Software Gourmet Guide & Cookbook | £ 7.15 |
| Best of Micro, Vol 1 | £ 5.50 |
| Best of Micro, Vol 2 | £ 5.50 |
| Programming the 6502 (Zans) | £ 7.95 |
| Programming the 6502 (Foster) | £ 6.75 |
| 6502 Applications | £ 7.95 |
| 6502 Assembly Language Programming | £ 8.25 |
| The PET and the IEEE 488 (GPIB) bus | £ 9.95 |

GENERAL

See Magazines and Subscriptions! See Osborne Books!

| | |
|---|--------|
| Microprocessors from Chips to Systems | £ 7.00 |
| Microprocessor Interfacing Techniques | £ 8.75 |
| Numbers, in Theory and Practice | £ 5.95 |
| Cheap Video Cookbook | £ 4.30 |
| CMOS Cookbook | £ 7.50 |
| IC OP-AMP Cookbook | £ 8.95 |
| RTL Cookbook | £ 4.25 |
| TTL Cookbook | £ 7.50 |
| Ciarcias Circuit Cellar | £ 5.50 |
| First Book of Kim | £ 7.00 |
| Buyers Guide to Microsoftware | £ 2.40 |
| Calculating with BASIC | £ 4.95 |
| Computer Programs that Work (In BASIC) | £ 2.95 |
| BASIC Software Library: (Listings) | |
| Vol 2: Maths, Engineering and Statistical Programs | £17.50 |
| Vol 3: Advanced Business Programs | £26.95 |
| Vol 5: Experimenters Programs | £ 7.95 |
| Vol 6: Miniature Business System | £32.50 |
| Vol 7: Chess/Medbil/Wdproc. Programs | £26.95 |
| Vol 8: Homeowners Programs | £14.05 |
| Best of Interface Age: Software | £ 9.95 |
| Bar Code Loader for 6800, 8080, Z80 and 6502 | £ 1.75 |
| Best of BYTE | £ 8.95 |
| Scelbi BYTE Primer | £ 8.95 |
| Best of Creative Computing, Vol 1 | £ 6.95 |
| Best of Creative Computing, Vol 2 | £ 6.95 |
| Program Design | £ 4.25 |
| Programming Techniques: Simulation | £ 4.25 |
| PIMS — A Database Management System | £ 5.95 |

HOW TO PURCHASE

Send cash, cheque, PO or credit card no. to L.P. Enterprises, Room PC, 11 Cambridge House, Cambridge Road, Barking, Essex IG11 8NT. 01-591 6511. All payment must be in sterling and drawn against a UK bank.

The titles specified here are but a small selection of our range. For the complete list, send an SAE to the above address, or come and visit our showroom (open during office hours).

(continued from page 83)

respectively. In that way, one of the chips would produce eight input port strobes to activate the port tri-state buffers while the other would produce eight separate strobes to drive the output port latches.

The eight lines of each chip would be selected by the bottom three address lines. Following that, everything was plane sailing and it was only necessary to decide on the organisation of buffers, latches, and the two UARTs to make up the complement of I/O.

Because UARTs serialise data, that must be done at a pre-determined speed as different types of external device might wish to receive, or transmit data at different bit rates — figure three. With hindsight, we realised we had made a slight mistake with Triton by allowing a variable setting of the baud rate. That was a problem for the home constructor with no access to precise frequency-measuring equipment and it made necessary complex instructions and sample tapes to aid the setting-up.

Baud-rate range

This time, we were determined to have all baud rates crystal-controlled and locked to the master clock. To provide versatility, we needed to provide a range of different baud rates which would match most conceivable contingencies.

The UARTs we were to use required clocks which were sixteen times the frequency of the desired baud rate and, for the sake of standardisation, we wanted these to fall into the binary series of 4,800, 2,400, 1,200 baud.

To obtain the highest of our baud rates would have required a clock frequency of 76,800Hz whereas our master clock frequency would be either 2 or 4MHz. Using binary division techniques, there is no way one can produce a precise 76.8kHz from 2MHz however, by dividing 2MHz

Figure 3. The interface of a UART to a data busbar provides a serial I/O device utilising three ports.

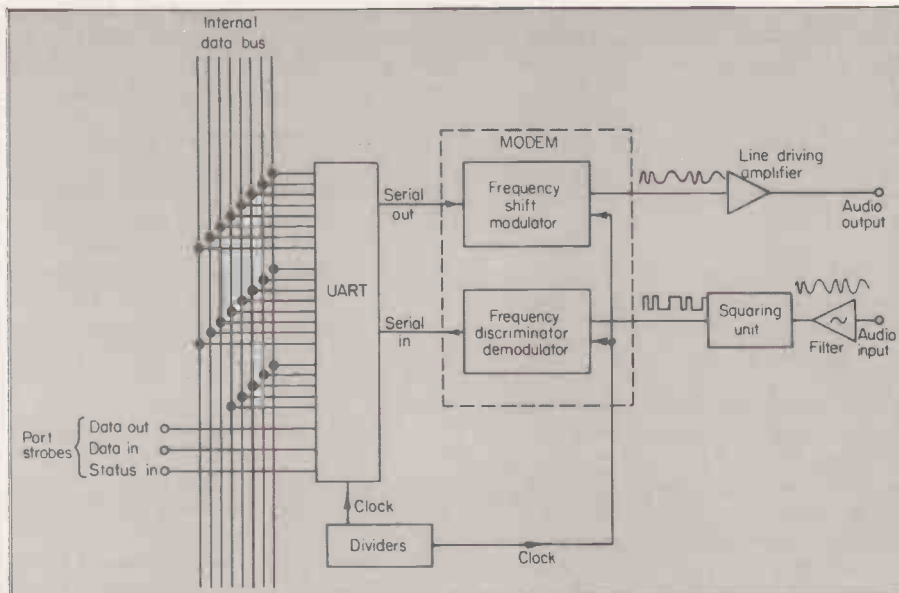
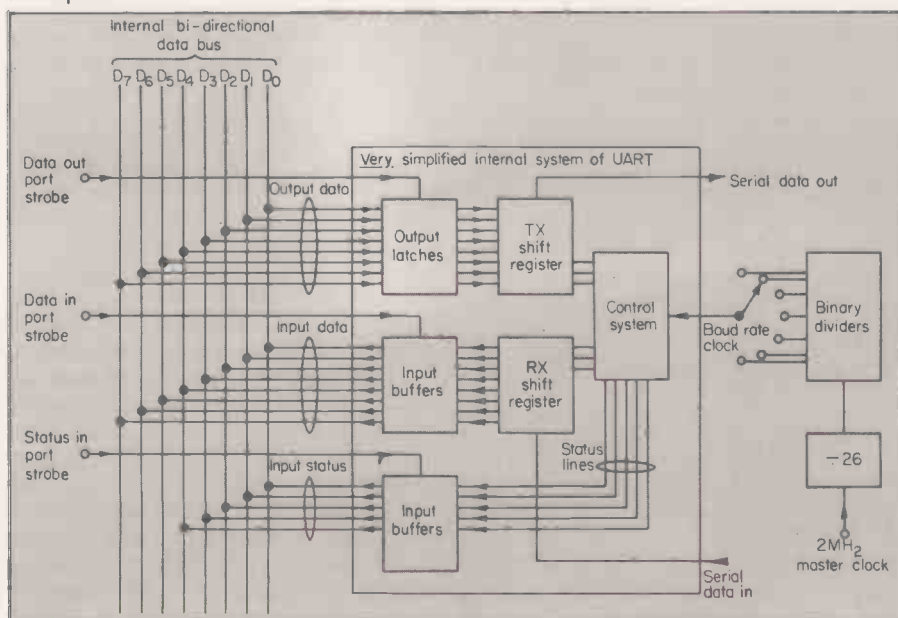

Figure 4. Block schematic of the elements needed to provide a serial communications or tape I/O device.

by 26 will give 76.923kHz which is not far out and when divided by the factor of the UART would give a maximum baud rate of 4,807.69 instead of the precise 4,800 we were looking for.

Now it is comparatively easy to divide by 26n using binary techniques — a modulo-13 counter followed by a divide-by-two to square up the ensuing non-symmetric signal. So we agreed, very quickly that an error of precision of roughly 8in. 5,000 for our baud rate should be acceptable in most quarters.

Further divide-by-two stages would give us all the binary sub-divisions to give a useful range of baud rates including those at 600 and 300 baud. The latter were important because we had decided to use the same Modem system that had worked so successfully in Triton. This is a single-chip Modem controlled by a 1MHz clock — derived easily from our system clock —

which produces internationally-standard frequency-shifted tones to define the logical ones and noughts.

That meant that the Modem could be used for tape recording and for communications purposes, depending on the user's needs. Using the same system also meant compatibility between our systems which could prove useful.

The maximum baud rate the Modem chip would handle, before aliasing problems with the carrier frequency start to occur, was 600 baud but our experience with Triton indicated that, unless very high-quality tape recorders were used, the most reliable data rate for recording purposes was 300 baud — figure 4.

Medium speed

By some standards, that is only medium speed but it did not worry us unduly as the Tuscan system was really designed with floppy discs in mind for program and data storage. Serious users would take advantage of the latter but domestic users, with rather lower budgets, would not find 300 baud much of a disadvantage if they wanted to start with a low-cost system and develop upwards to a disc system.

For communications purposes, it would be a real plus to be using standard frequency pairs for transmission and reception and they could easily drive acoustic couplers with very little extra interfacing.

We felt we ought to keep the on-board VDU a simple and straightforward as possible. It never had been the intention to make this a memory-mapped system. It was to be utility but sufficiently useful to handle business and monitoring applications for process control and the like.

Having the S-100 busbar would allow a wide range of alternative VDUs for those who had special applications — including colour, vector graphics, etc. For that reason, we decided to stay with the well-

(continued on next page)

(continued from previous page)

tried Thomson CSF 96364 chip that had done such sterling service on Triton.

We had learnt sufficiently about it to improve over our Triton application and Brendan Owen had some excellent ideas about how he would be able to speed its rate of display through firmware. Looking back after the event, he was able to make the most spectacular increase in speed — effectively 1,200 characters per second and faster than some memory-mapped displays — figure 5.

The 96364 is now available to match various international television standards and it would enable us to offer Tuscan to a wider range of international markets including the U.S., merely by changing this chip and, in the case of the States, the transformer.

Again, for versatility, we decided to use our own character-generation memory in the form of EPROM. By doing that, we could include full upper- and lower-case as well as graphics in a single chip and provide an option for special characters for dedicated, or foreign language, applications.

Block schematic

As the on-board VDU would be operating as an I/O device the whole of its circuit could, if desired, be left out on the final board without interfering with the main workings of the computer. The only thing the user who did not require it would be paying for would be a small area of redundant PCB.

By now, almost all the main-board system had been sketched in block schematic form with detailed circuitry here and there and the time had arrived to check whether the theory would work in practice. I have always hated breadboarding in any shape or form. I find it time-consuming, messy and sometimes misleading — especially when lay-out is critical.

Some parts of the system I knew would work from previous experience — they included most of the I/O, the interrupt system and the memory driving circuits.

Figure 5. Block schematic of a VDU system operating as a parallel I/O device.

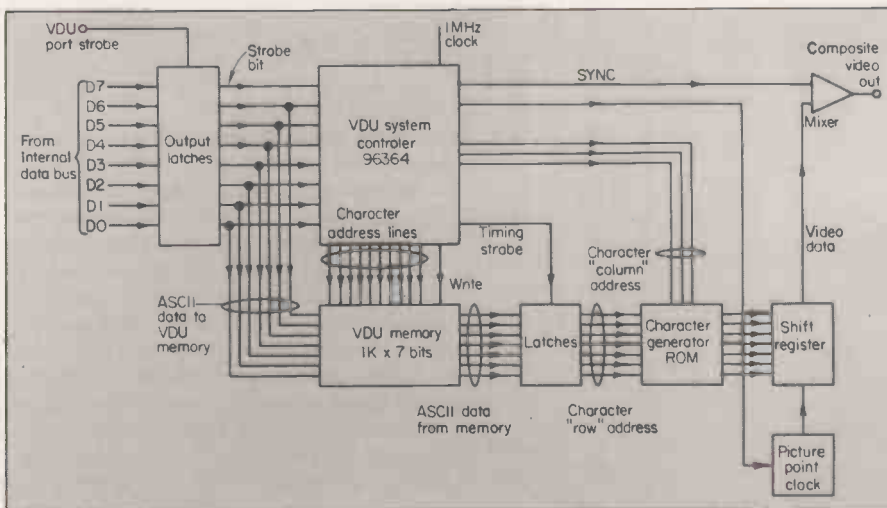

The big imponderable was the Z-80 to S-100 interface and the master timing. At the frequencies I would be using, I doubted whether a breadboard would be of much value.

On many occasions in the past, I have found it positively beneficial to spend time on converting theoretical drawings into PCB lay-outs before any attempt to test theoretical circuitry. In a strange way, it concentrates the mind and frequently indicates mistakes or omissions — probably because it forces one to refer to data sheets and pin-out diagrams as one goes which can often identify a lost or omitted signal.

I think I must have spent the best part of two months during the latter part of 1979 trying over and over again to fit the semblance of a lay-out on a large — four times life size — piece of squared paper. As I expected, many minor mistakes in the original concept were uncovered in the process but nothing untoward.

Computer-aided design might be the answer to this time-consuming exercise but the problem is that it presupposes the original design concept is correct. It might produce a wonderful-looking board which does not work.

Relying on the computer to do the painstaking job of lay-out does not force the designer right into the system — he might not notice that parallel pair of lines carrying signals which are going to interact with each other. Perhaps computer-aided design would remove a good deal of the tedium but in the long run, may not necessarily cut the time involved.

Whether or not that is true is irrelevant because I did not have any expensive computer-aided design facilities at my disposal and to help keep myself sane, that is what I kept telling myself.

I think that it was at about the sixth lay-out in pencil that I felt I had the system properly mapped and it fitted within a board area only slightly larger than our initial concept. The moment had now arrived to discuss the whole concept in committee before the design was frozen.

This meeting was crucial because the Transam software specialists now had their first real opportunity to see a consolidated design of the system and identify what they were designing for. At the meeting, I was praying that there would be no last minute changes in design specification — almost certainly that would have entailed a trip back to the drawing board to start all over again.

Fortunately, there were no major design changes although a few minor modifications were suggested and embodied in pencil. The major question, however, was still unanswered — would it work?

Vital decision

Having been over the system time and time again, I was reasonably confident that there were no major mistakes but there might have been a fundamental flaw in the principles I was adopting. It is a very lonely feeling to be the only person at a meeting who knows where the weaknesses are in a design when the decision has to be made to put real money into it.

That is exactly what Transam now had to do to prove the design. To Transam, it was not just a matter of investing a few hundred pounds in making a prototype board; they now had to confirm orders amounting to tens of thousands of pounds for some of the specialised components.

Tuscan would require keyboards, tool work for case manufacture, special transformers, disc drives and power supplies not to mention large stocks of memory chips and other integrated circuits some of which required several months for delivery.

Some of the PROMs and EPROMs I had specified required expensive upgrading of ROM-burning equipment and all that had to be ordered to have it available in time for the system's launch. Until then, Brendan Owen had been working on the framework of supporting software but now he had to concentrate fully on the details because it would now be only a month or so before I had a hardware system ready for test and would be needing a monitor program.

The decision was made; we would freeze the design and venture forward. For my part, I had to convert my scale drawings into precise artwork from which the prototype board would be made. That is easily said but not so easily done.

A clean neat appearance is important, not only for aesthetic quality but neat groupings of busbars can help considerably should any troubles ensue.

It took about six weeks of painstaking work to convert the pencil-drawn lay-out into good quality artwork and, in so doing, I reckon I consumed about two kilometres of tape. Eventually, the job was done and the artwork went off to the board manufacturers and I could return to pen and paper to work out the coding for the all important Z-80 to S-100 encoding ROMs. □

Apple Price List

| Product Code | Description | Price (£) | Product Code | Description | Price (£) |
|--------------------------------|---------------------------------------|-----------|-----------------------------------|--|-----------|
| HARDWARE | | | DOCUMENTATION | | |
| A2S1016P | APPLE 16K VIDEO OUTPUT ONLY | 695.00 | A2L001A | APPLE II REFERENCE MANUAL | 11.00 |
| A2M0003 | DISC DRIVE WITHOUT CONTROLLER | 299.00 | A2L0002 | 6502 HARDWARE MANUAL | 9.00 |
| A2M0004 | DISC DRIVE WITH CONTROLLER | 349.00 | A2L0003 | 6502 SOFTWARE MANUAL | 9.00 |
| A2M0016 | 16K ADD ON RAM | 69.00 | A2L0005 | APPLE II BASIC PROGRAM MANUAL | 6.00 |
| CARDS & ACCESSORIES | | | A2L0006 | APPLE II REFERENCE MANUAL | 6.00 |
| A2B0001 | PROTOTYPE/HOBBY CARD | 15.00 | A2L0012 | DOS 3.2 MANUAL | 6.00 |
| A2B0002 | PARALLEL PRINTER INTERFACE CARD | 130.00 | A2L0018 | APPLE II BASIC TUTORIAL MANUAL | 6.00 |
| A2B0003 | COMMUNICATIONS CARD | 104.00 | GENERAL ACCESSORIES | | |
| A2B0005 | HIGH SPEED SERIAL INTERFACE CARD | 113.00 | A2D0000 | (10) BLANK APPLE DISCETTES | 32.40 |
| A2B0006 | PASCAL LANGUAGE SYSTEM | 299.00 | A2M0009 | VINYL CARRYING CASE | 16.00 |
| A2B0007 | CENTRONICS CARD | 130.00 | AD/LB | MINI DISC LIBRARY BOX | 2.64 |
| A2B0009 | APPLESOFT FIRMWARE CARD | 116.00 | MD5172 | DISCOFLEX FILING CASE—MINI | 12.64 |
| A2B0010 | INTEGER CARD | 116.00 | APP1 | APPLE DESK TWO TIER | 145.00 |
| MHP-X003 | MOUNTAIN HARDWARE CLOCK/CALENDAR CARD | 160.00 | APP2 | PRINTER TABLE | 92.00 |
| MHP-X006 | MOUNTAIN HARDWARE SUPERTALKER | 171.00 | APPLETEL | APPLETEL SYSTEM | 595.00 |
| MHP-X007 | MOUNTAIN HARDWARE ROM PLUS BOARD | 116.00 | DUST/APP | DUSTCOVER FOR APPLE II | 5.35 |
| MHP-X015 | MOUNTAIN HARDWARE ROMWRITER | 101.00 | E2B013 | APPLEJUICE RESERVE POWER SUPPLY | 148.00 |
| E2B100 | EUROCOLOUR CARD | 79.00 | PRINTERS & ACCESSORIES | | |
| E2B101 | APPLE BLACK & WHITE MODULATOR | 14.00 | A2M0034 | SILENTYPE 80 COLUMN GRAPHICS PRINTER | 349.00 |
| E2B102 | A1-02 DATA ACQUISITION CARD | 180.00 | A2C0001 | 10 ROLLS OF THERMAL PAPER FOR SILENTYPE PRINTER | 28.00 |
| 10-5-16 | ALF MUSIC SYNTHESIZER CARD | 142.00 | HUSH100/A | MICROHUSH 100 PRINTER C/W APPLE INTERFACE | 266.00 |
| 10-5-17 | ALF TIMING MODE INPUT BOARD | 14.00 | HUSHPAP | 16 ROLLS THERMAL PAPER 80FT LONG | 22.00 |
| 13-3-2 | ALF ALBUM MUSIC DISKETTE NUMBER ONE | 12.00 | HUSHPAP/E | 2 ROLLS THERMAL PAPER 80FT LONG | 5.00 |
| 13-3-4 | ALF ALBUM MUSIC DISKETTE NUMBER TWO | 12.00 | TIGER/G | PAPER TIGER PRINTER WITH GRAPHICS OPTION | 598.00 |
| 13-5-5 | ALF ALBUM MUSIC DISKETTE CHRISTMAS | 12.00 | TIGER/C | CONNECTOR CABLE FOR TIGER PRINTER | 9.00 |
| A2M0015 | HEURISTICS SPEECH LAB | 122.00 | TIGER/D | GRAPHICS SOFTWARE FOR TIGER PRINTER | 20.00 |
| A2M0019 | PROGRAMMERS AID 1 | 27.00 | TIGER/P | TIGER PAPER 2,000 SHEETS 11" x 9 1/2" S/PART | 35.92 |
| A2M0027 | AUTO START ROM PACK | 38.00 | TI810 | TEXAS OMNI 810 PRINTER | 1450.00 |
| A2M0029 | GRAPHICS TABLET | 462.00 | LP5 | PAPER 2000 SHEETS 11" x 15" S/PART | 14.06 |
| E2B104 | HEURISTICS CONTROLLER 70 | 52.00 | LP9 | PAPER 3000 SHEETS 8" x 12" S/PART | 14.85 |
| E2B105 | HEURISTICS SPEECHLINK 2000 | 160.00 | VIDEO MONITORS | | |
| E2B107 | IEEE INTERFACE | 212.00 | VM129 | 12" BLACK AND WHITE VIDEO MONITOR | 189.00 |
| SOFTWARE | | | VM910 | 9" BLACK AND WHITE VIDEO MONITOR | 127.00 |
| A2D0005 | CONTRIBUTED SOFTWARE VOL 3-5 | 60.00 | VM906 | 9" HIGH RESOLUTION BLACK AND WHITE VIDEO MONITOR | 148.00 |
| A2D0006 | CONTRIBUTED SOFTWARE VOL 1-2 | 27.00 | VM/C | CABLE FOR VIDEO MONITOR | 9.00 |
| A2D0009 | MICROCHESS 2.0 CHESS DISK | 15.00 | | | |
| A2D0010 | DISC UTILITY PACK | 15.00 | | | |
| A2D0012 | APPLE BUSINESS CONTROLLER PROGRAM | 340.00 | | | |
| A2D0013 | APPLE POST PROGRAM | 27.00 | | | |
| A2D0018 | APPLE BOWLING DISCETTE | 9.00 | | | |
| A2D0025 | APPLE CASHIER PROGRAM | 194.00 | | | |
| A2D0026 | APPLE WORD PROCESSING PROGRAM | 42.00 | | | |
| A2T0013 | MICROCHESS 2.0 CHESS CASSETTE | 15.00 | | | |
| E2D001 | VISICALC DISC & BOOK COMPLETE | 95.00 | | | |

Prices exclusive of carriage and VAT and are correct at time of going to press. Available from Apple Dealers all over the UK—for your nearest please contact Microsense Computers. Dealer/OEM enquiries welcome.

microsense computers limited

Finway Road, Hemel Hempstead, Herts HP2 7PS
 Tel (0442) 48151 and 41191
 Telex: 825554 DATEFF G



Apple is a trade mark of Apple Computer Inc., Cupertino, C.A., USA



Circle No. 173

Finding significant trends with the Runs Test

Owen Bishop shows how the Runs Test on the micro can be used to detect clustering and significant trends in business and survey statistics.

EARLIER articles in this series in November and December 1979 have demonstrated that a good deal of useful statistical analysis can be done by microprocessors — even with such small systems as the Science of Cambridge MK14. The tests described in those articles have all belonged to the group known as distribution-free tests, or non-parametric tests. Their main features make them ideal for microprocessors:

- The amount of number-crunching required is minimal; microprocessors are not really designed for number-crunching so that makes things easier for them.
- The amount of listing, sorting and ranking of data is large; those jobs are done easily by microprocessors, so we are making the best use of their special capabilities.

Those reasons alone are not enough to justify using distribution-free tests to analyse data, but there are sound statistical reasons which make this kind of test the only really acceptable one for many types of data.

That point was dealt with in November 1979. There, an example of a distribution-free test was given in the form of the Runs Test. Essentially, the function of that test is to look at a series of events of two different kinds and to assess whether or not the events of one kind tend to be clustered together.

House survey

An example was given of a street of 20 houses surveyed to find what brand of TV set was installed. A house with brand A was scored '1' and houses with other brands were scored '0'. The result of the survey might have been:

1110001111110001000

The question is: "Are the houses with a brand A set clustered together more than we would expect than if the '1's and '0's were simply scattered at random along the street"? If there are, it could be interpreted as meaning that people tend to copy their neighbour over the matter of choosing a TV set.

Another example could be a record of rainy days during a given month. If '1' means rain and '0' means no rain, the record might be:

000001111100000011100000011111

runs
or spells

1 2 3 4 5 6

Here we have 14 rainy days, 17 dry days, and six runs, or spells, of weather of one kind or the other. Does our weather

tend to occur in spells? If it rained yesterday, should I take my umbrella when I go out today, even though it is not raining at the moment?

Obviously, if the record has been 0010101011011000111010100010001 We would say that there is no rhyme or reason to the weather, and take the umbrella anyway, just to be on the safe side.

The Runs Test tells us just how few runs there must be to show the clustering effect is significant. For six runs in 30 days the effect is significant — our weather tends to occur in spells. For 20 runs, as in the second example, it clearly is not.

A table of the critical value of runs has been calculated and shows that for 30 events, seven runs or fewer is highly significant — $p = 0.0006$, meaning that you can obtain seven or fewer runs by pure chance only six in 10,000 times, which we can safely ignore.

Business application

Nine runs or fewer are significant for $p = 0.007$ — only seven in 1,000 chance of obtaining this few by chance — and 11 runs or fewer are significant for $p = 0.046$ — 46 in 1,000 chance, which most people would consider as still indicating a significantly small number of runs.

If you obtain more than 11 runs, no effect of clustering or rainy spells has been demonstrated.

The Runs Test can also be used in another application — one of interest to people in business, though also of interest in many other fields.

Suppose that the monthly profits in £10,000s from a small business for a period of two years are these, in order: 43414749475123195510993107

Is there a trend? Are profits increasing over the two year period? If you plot a graph of the figures, a rising trend is apparent, but is it significant? Opinions are not good enough, but fortunately the Runs Test can give an unbiased assessment of the situation.

The first step in analysing the data is to write it again, in order. In other words, we sort it — something a micro can do in an instant.

11123334444455577799991010

Next, we find the median or middle value of the set of data. There is no actual middle value for this data because there is an even number of items. The median falls between 4 and 5.

We can say that all profits of £40,000 and less are below the median, while all of

£50,000 and more are above the median.

Now we write the profits, month by month in order and, below each, write a '0' if it is below the median, or a '1' if it is above:

43414749475123195510993107
000001010110000111111011

We are back to the Runs Test again for we have 12 '0's, 12 '1's and there are 10 runs. This is too many runs to indicate a statistically-significant effect. Despite the fact that there seem to be more '1's toward the right-hand end of the string, there is no evidence of clustering and, therefore, no evidence that the '0's and '1's are anything other than randomly scattered over the 24 months in question. There is no evidence for an upward — or a downward — trend in profits.

The test can be used to look for trends in any series of data, provided that the trend, if any, is continuously in one direction. The effect of an upward trend followed by a downward one would cancel out the clustering effect.

Then it might be more appropriate to split the data into two sections, one for the supposed upward trend and one for the supposed downward trend, and analyse each separately.

Similar approach

The program, written for TRS-80 II 16K, performs both versions of the runs test. It can be adapted readily to other versions of Basic. It is highly sophisticated when compared to the machine-code program in the earlier article but, nevertheless, goes about the test in much the same way.

The main addition is a routine for accepting a series of numerical data and converting them to a series of '0's and '1's, ready for testing for trend, using the Runs Test.

The program for the simple Runs Test for clustering operates on data entered as a string of '0's and '1's, as in the original machine-code program. In this program, up to 240 items can be accepted into the string.

When testing for trends, up to 100 items of data can be accepted and processed. Data can be positive or negative, integers or floating-point variables. The program works with single-precision variables — up to six significant figures. Any item entered which has more than six significant figures is rounded-off to six figures automatically and the rounded-off amount is displayed and used in the program.

The table of critical values for the number of runs, u , has been calculated for up to 40 items of data, and assumes that the number of '0's does not differ by more than six from the number of '1's. It would be possible to write a program to calculate critical values, given the numbers of '0's and '1's for numbers greater than 20 of each, but these calculations involve computation of factorial numbers and immediately we are in the realms of number-crunching.

The program runs much faster if the table of critical values is incorporated — lines 940-1000 — as it was in the machine-code program, and the value required is looked up by the program — lines 350 to 470.

Although there are ways of short-cutting the calculation of expressions involving factorials, there is no need to bother with them in this case. When there are more than 40 items we can use an approximate method, as follows.

First we calculate a quantity $\mu_u = \frac{2n_1n_2}{n_1+n_2}$ and a quantity $\sigma_u^2 = \frac{2n_1n_2(2n_1n_2 - n_1 - n_2)}{(n_1+n_2)^2(n_1+n_2+1)}$

In those quantities, n_1 is the number of '0's — represented by variable $N0$ in the program — and n_2 is the number of '1's — represented by $N1$. Finally we calculate

$$t = \frac{\mu_u - u}{\sigma_u}$$

Where 'u' is the number of runs we had, and 't' is the value for comparison with the value of 't' given in the well-known student's table for 't', for infinite degrees of freedom. Those values are incorporated directly into the program in lines 520 to 570, where 't' is represented by variable 'Z'.

On the way to calculating t, the statements are simplified by calculating $N2 (= n_1 + n_2)$, and $N4 (= 2n_1n_2)$. The value of $N3$ is the integer of $(n_1 + n_2)/2$ so that, if n_1 and n_2 are unequal, we obtain a value less than their average.

That is used when looking up values in the critical table for 'u'. This means that we apply slightly stricter criteria when deciding how small a number of runs is acceptable as significant.

That helps to offset the fact that the numbers of '0's and '1's are unequal, for they should really be equal for the quoted values of 'p' to apply.

The program warns the user to be cautious about accepting the value of 'p' in those circumstances — line 300. When testing for trend, the warning appears if the number of items is odd, for then the number of '0's must always be one greater than the number of '1's.

Since the difference is slight, the effect on probability levels is only marginal and the warning can usually be ignored. Note that line 290 rejects the data if there are fewer than eight items. With only eight events, even as few as two runs is not

(continued on next page)

```

RUNS TEST PROGRAM
10 CLEAR 1000
20 DEFINT H-V: DEFSTR A-D: DIM F(99): DIM G(99,1)
30 CLS
40 PRINT TAB(20) "RUNS TEST PROGRAM": PRINT
50 INPUT "DO YOU WISH TO TEST FOR CLUSTERING (2), OR FOR TREND (T
60 IF A = "C" PRINT: PRINT "CLUSTERING": GOTO 100
70 IF A = "T" PRINT: PRINT "TREND": GOTO 580
80 PRINT "INORDER: BEST RESPONSE; PLEASE TYPE C OR T WHEN NEXT N
  REQUESTED"
90 FOR J=1 TO 2000: NEXT: GOTO 30
100 PRINT: PRINT "ENTER DATA IN ORDER AS (0) OR (1). KEY 'ENTER' W
  HEN DATA ENTRY IS COMPLETE": PRINT
110 INPUT D
120 C=LEFT$(D,1)
130 IF C="0" OR C="1" THEN 140 ELSE 200
140 U=1
150 IF C="0" N0=1
160 IF C="1" N1=1
170 FOR J=2 TO LEN(D)
180 B= MID$(D,J,1)
190 IF B="0" OR B="1" THEN 230 ELSE 210
200 B=C
210 PRINT "INVALID DATA ENTERED ( "; B; ", FOR EXAMPLE)"
220 GOTO 100
230 IF B = "0" N0=N0+1
240 IF B = "1" N1=N1+1
250 IF B=C THEN 270
260 U=U+1
270 C=B: NEXT
280 N2=N0+N1
290 IF N2<8 PRINT "INSUFFICIENT DATA FOR ANALYSIS": GOTO 90
295 IF ABS(N0-N1)>6 PRINT "NUMBERS OF ITEMS OF THE TWO TYPES DIF
  FER BY MORE THAN 6. VALID ANALYSIS IS NOT POSSIBLE": GOTO 90
300 IF N0<>N1 PRINT "NUMBER OF ITEMS OF ONE TYPE IS NOT EXACTLY
  EQUAL TO THE NUMBER OF ITEMS OF OTHER TYPE. ACCEPT VALUE OF P W
  ITH CAUTION"
310 PRINT: PRINT "ZEROS = "; N0; ", ONES = "; N1
320 PRINT "TOTAL DATA = "; N2; "TOTAL RUNS = "; U: PRINT
330 IF U>20 THEN 400
340 N3=(N0+N1)/2
350 FOR L=1 TO 17
360 READ M
370 IF M=N3 THEN 410
380 FOR K=1 TO 6
390 READ X 'DUMMY READ
400 NEXT K,L
410 FOR J=1 TO 3
420 READ V
430 IF UK<V THEN 460
440 READ X: NEXT J 'DUMMY READ
450 PRINT "THE DATA ARE NOT STATISTICALLY SIGNIFICANT": PRINT: END
460 READ P: U = P*0.0001
470 PRINT "THE DATA SHOW A SIGNIFICANT EFFECT, WITH P = "; U: PRINT
480 N4 = N0 * N1 * 2
490 Y1 = N4 / N2 + 1
500 Y2 = SQR(N4 * (N4 - N2) / N2 / N2 / (N2 + 1))
510 Z = (Y1 - U) / Y2
520 IF Z < 1.65 PRINT TAB(20) "T = "; Z: GOTO 450
530 W = 0.05
540 IF Z >= 1.96 W = 0.025
550 IF Z >= 2.33 W = 0.01
560 IF Z >= 3.29 W = 0.0005
570 PRINT TAB(20) "T = "; Z: PRINT: GOTO 470
580 PRINT: PRINT "ENTER ITEMS OF DATA, WITH SIGNS IF NECESSARY. P
  RESSES 'ENTER' AFTER EACH. AFTER LAST ITEM, ENTER 999999": PRINT
590 INPUT "DATA ENTERED = "; E: PRINT
600 IF E=999999 THEN 650
610 N2=N2+1
620 PRINT "DATA RECORDED", "NUMBER OF ITEMS"
630 PRINT: PRINT E, N2
640 PRINT: G(N2-1,1)=E: GOTO 590
    
```

(continued on next page)

(continued from previous page)

significant. The program also rejects data in which n_1 and n_2 differ by more than six — line 295 — for the same reasons.

To minimise the length of the program, remarks have been kept brief. Lines 10-30: initialisation.

Lines 40-90: determining whether the user wishes to test for clustering or for trends.

Lines 100-270: processing the clustering data.

Lines 280-320: data — either for clustering test or for trend test — checked for validity, and, if valid, the results are printed. Line 330: if more than 20 items, the program branches to calculate 't'.

Lines 340-470: reading the table of critical values — DATA — and printing the interpretation.

Lines 480: calculating $t(Z)$ and determining $p(W)$, then back to lines 450 or 470 to print the interpretation.

Lines 580-640: requesting data for trend testing. Data are entered one by one. Lines 650-670: data copied from first column of matrix G to array F.

Lines 680-790: bubble sort of array F. Lines 800-840: finding the median of the values arrayed in F, after first determining if the number of values present is even or odd. Median is Z.

Lines 860-910: comparing each value in the first column of G to the value of Z.

Lines 920-980: table of critical values, based on Table 84, from Bishop O N, Longman, London, second edition, 1971. □

(continued from previous page)

650 FOR M= 0 TO N2-1

660 F(M)=J(M, 1)

670 NEXT M

690 FOR I = 1 TO N2-1

690 J=0

700 FOR K = 0 TO N2-2

710 IF F(K)<=F(K+1) THEN 760

720 Y = F(K)

730 F(K)=F(K+1)

740 F(K+1)=Y

750 LET J=J+1

760 NEXT K

770 L=L+J

780 IF J=0 THEN 800

790 NEXT I

800 N=N2/2 'N IS SINGLE PRECISION

810 Q=N2/2 'Q IS INTEGER

820 IF W=Q THEN 840

830 Z =F(Q):GOTO 850

840 Z = (F(Q-1)+F(Q))/2

850 FOR J = 0 TO N2-1

860 IF G(J, 1)<=Z THEN N0=N0+1: G(J, 0)=0: GOTO 880

870 N1=N1+1: G(J, 0)=1

880 U=1

890 FOR J=1 TO N2-2

893 IF G(J, 0)<>G(J+1, 0) THEN U = U+1

900 NEXT J

910 GOTO 290

920 DATA 4, 0, 0, 0, 0, 2, 290, 5, 0, 0, 2, 80, 3, 400, 6, 0, 0, 2, 20, 3, 130

930 DATA 7, 2, 6, 3, 40, 4, 250, 8, 2, 2, 4, 90, 5, 320, 9, 3, 4, 4, 30, 6, 450,

940 DATA 10, 4, 10, 5, 40, 6, 190, 11, 4, 3, 6, 70, 7, 230, 12, 5, 5, 7, 90, 8, 300

950 DATA 13, 5, 2, 7, 40, 9, 340, 14, 6, 4, 8, 60, 10, 410, 15, 7, 6, 9, 70, 11, 460

960 DATA 16, 8, 9, 10, 90, 11, 230, 17, 8, 3, 10, 40, 12, 270

970 DATA 18, 9, 5, 11, 50, 13, 300, 19, 10, 7, 12, 60, 14, 350

980 DATA 20, 11, 9, 13, 80, 15, 380

geveke **LETTER QUALITY PRINT** electronics **AT REALISTIC PRICES**

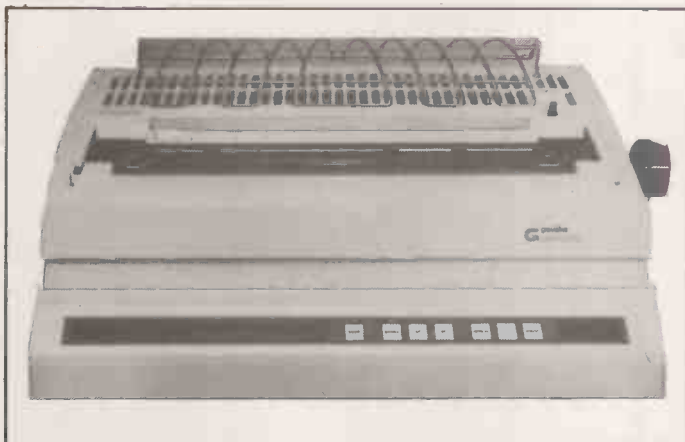

Diablo 630

- Interchangeable Metal/Plastic Print Wheels
- Automatic Bi-directional Printing
- Word Processing Options
- Diablo Quality and Reliability
- Paper Handling Accessories

Our volume buying means competitive pricing for our OEM's. Our size and reputation ensure reliability and support not only in Britain but across Europe. Extensive stocks mean we can usually deliver when others can't.

FOR INNOVATIVE DISTRIBUTION TO OEMs

Call us.. Geveke Electronics Ltd. RMC House, Vale Farm Rd. Woking.. 04862 71337

• Circle No. 174

“If you want what’s best for your PET, choose Commodore software.”

Kit Spencer
General Manager
of Commodore Systems
360 Euston Road
London NW1 3BL



The Commodore PET is Britain’s best selling micro-computer, with over 10,000 already installed in a wide range of fields, including Education, Business, Science and Industry.

This has led to a tremendous demand for high quality software.

And Commodore has met this demand by producing a first class range of programs, now available from the nationwide network of Commodore Dealers.

Commodore’s support also includes training courses, a Users’ Newsletter and Official Approval for compatible products of other manufacturers who reach agreed standards.

COMMODORE PETPACS

Over 50 Petpacs of programs are available (mainly on cassette) from Commodore Dealers.

These cover such popular titles as Strathclyde Tutorial, Statistics pack 1, Assembler Development System, Stock Market Trends and the Treasure Trove Collection of game packs including the award winning Star Trek, which is packaged with Petopoly. Prices are from £5 to £50.

TRAINING COURSES AND SEMINARS

PET systems are simple to use and any normal advice or assistance

NEW BUSINESS SOFTWARE PROGRAMS ON DISK

Commodore’s Floppy Disk Unit and high-speed Printer, combine with the PET to form a complete system (ideal for running a business) for under £2,500.

Commodore also produce a growing range of business software on disk available from Official Business Software Dealers.

Business Information System – COMBIS £150 + VAT

Combis facilitates the storage and instant retrieval of all kinds of company records, from personnel files to mailing lists and printed address labels.

Stock Control – COMSTOCK £150 + VAT

Comstock provides an accurate, up-to-the-second and comprehensive stock position for as many as 1,300 products.

Word Processor – COMWORD £75 + VAT

Comword turns the system into an excellent word processor.

Payroll – COMPAY £150 + VAT

Compay is a new, comprehensive payroll package.



you may need can be obtained from Commodore Dealers.

On the other hand, for rapid training on a basic or advanced level, you will certainly be interested in Commodore’s intensive 2 and 3 day residential courses. We also run one day general appreciation seminars.

PET USERS’ NEWSLETTER

This is Commodore’s official method of sharing new information and ideas between the many thousands of PET users. The newsletter is published regularly and for an annual subscription of £10 you can start receiving copies now.

Look out for this sign. It tells you that compatible products of other manufacturers have met with our standards of approval.



(Tick the appropriate boxes)

To: Commodore Information Centre, 360 Euston Road, London NW1 3BL. 01-388 5702

I am a PET owner Please put me in touch with my nearest dealer

Please send me details of: Commodore PET Software

Training Courses & Seminars I would like to receive the Users’ Newsletter and enclose £10 annual subscription

Name _____ PC10

Address _____

Tel. No. _____

commodore
We made small computers big business.

• Circle No. 175

Now you can control your business for less than £2,500.

This could be your best investment opportunity yet. A complete computerised business system, including a Floppy Disk Unit, high-speed Printer and *Britain's best selling microcomputer* – the Commodore PET. All for under £2,500.

First Class Programs

A comprehensive range of first class programs is offered by *Commodore 'Business Software' Dealers*. These are available on disk from £50-£500. And they cover such applications as *Business Information, Stock Control, Word Processing, Payroll, Accounting and Mailing Systems*.

Service and Support

With over 10,000 PET computers installed in the UK, dealer support is growing fast. A nationwide network of 90 official

Commodore 'Business Software' Dealers ensures that service and technical facilities are close to every PET user. Our dealers can even offer you a 24 hour on-site maintenance agreement.

Training and Instruction

The PET Business System is self-contained and simple to use. Should you require personalised programs or extensive installation training this can be arranged with your *Commodore 'Business Software' Dealer* who can also give details of official *Commodore Training Courses*. These include intensive 2 & 3 day workshops to train you to write your own programs.

For full details about the Commodore PET Business System, Training Courses, Programs, and *'Business Software' Dealers*, simply fill in the coupon and post today.



To: Commodore Information Centre,
360 Euston Road, London NW1 3BL

Please send me details of the PET Computer Business Systems.

Name _____

Position _____

Company _____

Address _____

Tel. No. _____

If you have a particular application in mind please specify:

PC810

commodore
We made small computers big business.

• Circle No. 176

THE microcomputer can be sited wherever you please. It is a tool, but if that tool can store knowledge, it will reliably return that knowledge to the user.

If we ask it to tell us what kind of tree to plant in a shady corner of a garden with wretched rank soil where hitherto only ground elder has grown, and that ideally it should have glossy green leaves and shell-pink flowers, it can do it, reliably and consistently if, and only if, we have picked someone's brains for the results of a lifetime's experience in the garden.

This is exactly what a team of enterprising young programmers has done at Syon House Garden Centre, Brentford, Middlesex. What is there that a gardening encyclopedia has not already done, and in which you can browse to your heart's content?

In the first place, such a book will doubtless contain the information you want — if you know how to go about looking for it, but it does not provide specific answers to specific questions, such as what will grow in a neglected corner.

Grandiose scheme

It is also an expensive and diversionary way of selecting one piece of information from the distillation of a lifetime's experience in gardening. How often will you not sit down with your one question in mind and hours later still find yourself browsing over some grandiose scheme which your mean patch has no chance of containing?

From the garden centre's point of view, no doubt the scheme has further advantages; it points the customer promptly in the best direction, if he is a serious buyer. If he is not, he will swiftly be discouraged by the specificity with which he is asked to issue his instructions — nor will he be able to pass the day discussing the finer points of gardening with the resident sage, no doubt to the latter's irritation.

It may be argued that it reduces the

Keith Morrison updating the plant-enquiries program, and program developer Michael Connaghton.



Pet cultivates new role as gardener

essentially human component of such fine leisure activities as gardening — the kind of activity which, the proponents of the benignly-disemployed society tell us, we shall be enjoying several decades hence in far greater measure.

Yet the Syon Park Garden Centre is enormous, with a huge throughput of customers, and if each were to spend 10 minutes arguing about the price and specification of a terra cotta pot, nobody would ever buy a thing.

Jonathan Hall, the manager of the centre, is a micro-user, but it was Mal

by Martin Hayman

Seagroatt who conceived the plant-enquiry program. He has now left, to do a TOPS training course, and in his stead are two young men from the neighbourhood; Keith Morrison, who has now left school, and Michael Connaghton, who is taking A level in computing at Kingston College of Further Education.

It is Connaghton who is further expanding the possibilities of the Pet, working furiously on software-protection routines and other more commercially-slanted programs during the down-time on the Pet.

He learned on Kingston College's mainframe, which is now due for replacement: he is hoping that the college will opt for several Pets rather than another mainframe installation, and says he prefers the easier presentation and editing on a micro such as the Pet.

One of his first jobs was to create a dustbin file for all the anomalies which had crept into the data: "There were all

kinds of joke plants", Jon Hall told me. That, of course, is where there is no alternative to human experience; if you know, in your personal experience, that there is no such species, then you have to instruct the machine to dump that particular string.

The machine's precision is one reason to tread a little cautiously. The Pet system grew from a card index file which was maintained by charmingly-named George Orchard who, drawing from his own experience, has been compiling the details and habits of all the plants held at the centre on to a standard form.

The form is designed to yield rapidly the essential details wanted by the amateur gardener — height, preferred soil type, sunny or shady habitat, colour of flowers. Syon Park specialises in bushes, trees and shrubs, so fortunately those details can be minimised, even so, a file offering only 255 characters is restrictive.

The file is defined by the plant's Latin name, rather than the popular name; some of the former are long — more than 30 characters — leaving little space for other than schematised details, which causes some quaint abbreviations: Mother in Law's Tongue, otherwise known as Snake Plant, becomes Mum in Laws Ton.

File headaches

Errors in coding George Orchard's card files have caused headaches and it is infrequently that the comprehensive file of a particular plant is referenced directly. The title must be keyed-in character-perfect or the machine is foiled.

Problems of cross-referencing become more acute in the other programs which Jonathan Hall has in mind, for cross-pollination of fruiting trees and combatting disease.

Yet that is by no means impossible — it just requires a good deal of work. There is no doubt a wealth of gardening information residing in the brains of the Duke of Northumberland's many employees at Syon Park, and doubtless once you have found the right person, it is as quick to ask him why your roses should have burst out in blackspot; but as Jon Hall remarked, unprompted: "It is all very well to have someone who is an expert, but if he moves on somewhere else, he takes his information with him."

So the micro at Syon Park is not creating anything new. If you like, it is merely making knowledge available in a clear and concise way, quickly. The principle is the same, whether the subject is gardening, or law, or stress analysis or politics: information is the power to do something well. □

Winchester discs win ground in battle to lower bit prices

The Winchester hard-disc drive is one of the most vital areas of microcomputing, adding immeasurable power to the capabilities of even the humbler machines. Yet there remain some notable problems to overcome — particularly in the areas of archiving and interfacing — before it will become acceptable universally.

DEVELOPMENTS in memories are moving at such a rate that the Winchester hard disc, which seemed so revolutionary when it was first introduced, can now, five years later, already be described as an established technology. Yet while designers still grapple with the problems of non-standard interfaces for back-up storage, developments are proceeding apace in new materials for disc media and new types of read heads.

The Winchester eight-in. hard-disc drive is packed into a case about 4.5 × 9 × 18in. — a lunchbox. Some have a panhandle actuator motor at the back, and in most cases, the unit is intended to be rack-mountable or fit into the desk-top slots left vacant by the displaced floppy.

Essential features

The essentials of Winchester technology are small, lightly-loaded heads designed to land on the disc and a sealed contamination-proof disc and head chamber. The development of the technology was fuelled by the demand for higher capacity drives with a lower cost per bit and more reliability.

To increase disc capacity without increasing the recording area, two parameters can be changed. Tracks can be packed at a greater density and so can the number of bits on them.

The best way of improving signal definition and increasing recording density is to reduce the distance between the recording head and the disc. The physical misalignments of recorded tracks must also be minimised to allow the maximum signal to be read back reliably.

Mechanical tolerances

Those misalignments occur in exchangeable disc drives mainly because of the mechanical tolerances inherent in the construction of the spindle and pack-locating mechanism. Such differences occur between drives, between packs and even between different insertions of the same pack in the same drive. Thus the two obvious methods to increase the capacity of a disc drive are to make the discs non-removable and to fly the heads closer to the disc surface.

To have close-flying heads, it is vital to keep out dirt and to seal them in a contamination-proof chamber with continuously circulating and filtered air.

The next step is more subtle and involves an understanding of the mechanics of head flying, particularly at start-up and shut-down of the disc drive. At those times, in a conventional disc drive, the heads are inserted or retracted mechanically into the air stream above the already-spinning discs. The heads are unstable at load and unload times resulting in occasional contact between heads and discs, with debris and oxide build-up on the heads.

In a sealed chamber, that was unacceptable so Winchester heads are allowed to land on the disc as it stops. That results in stable take-offs and landings, but needs a head with minimum pressure on the surface on landing and also a special coating on the discs to reduce the possibility of oxide transference. Typically, Winchester heads have a pressure of eight to 10gm., compared with the 40 to 60 gm. of conventional heads.

Downward pressure

Since that pressure downwards towards the discs balances the lift created on the head by the airstream close to the disc surface, the lift has to be reduced and so Winchester heads are small. Dedicated landing zones also prevent damage in the head/disc contact phase. The heads do not land on data tracks and rapid start and stop times mean that they are in contact only briefly with the spinning disc — one-third to one-half revolution.

Most eight-in. drives have closed-loop, positive-pressure air circulation with filtration down to a few microns and motors outside the disc chamber. The IBM 3340 exchangeable packs even incorporated heads sealed within the pack but the design has not been imitated widely.

It appears that the extremely high engineering tolerances required for a drive to deal with such exchangeable cartridges are simply too daunting.

The last major innovation associated with the Winchester is the use of a special servo surface on one disc containing a pre-recorded clock track for each cylinder of the disc pack. Heads were previously positioned using inductive or optical transducers on the drive body controlling linear DC motors — voice coils via powerful servo amplifiers.

Positioning could also be either linear,

i.e., along the radius of the disc, or rotary-mounted on a pivot like the familiar record player. Rotary actuators are simpler with fewer bearings and mechanical parts, and most eight-in. drives have gone the rotary route.

The problem with using transducers is that positioning is always relative to the drive rather than to the disc — unless you mount the transducer on the disc pack. Increasingly high track densities have made more sophisticated positioning techniques necessary. Eight- and 14-in. Winchester have a "spare" head which reads the bottom servo surface to define where its parallel brethren are located.

Considerable accuracy

That means, however, that considerable accuracy is required in the assembly of disc packs and the read/write head comb assembly to ensure everything is parallel. Current eight-in. drives use servo track following with the exception of the Memorex 101 and the New World Computer 211 which use stepper motors and have noticeably lower track densities of 159 and 100 compared to an average of 500 track/in.

Other features found in some units are dual head/surface, DC spindle drive motors and the removal of all extraneous mechanisms, such as actuator motors, from the sealed chamber. For the best designed devices, a maximum time before failure of over 20,000 hours is realistic. The maximum time before failure of accompanying motors, power supplies and associated electronics is often around 5,000 to 10,000 hours — a reversal of the situation found commonly in older technology drives.

Further problems

Unfortunately, all of the ramifications of those designs are not without disadvantages. The most obvious one is the lack of an archiving capability to allow security dumping and the extension of the drive's database facilities.

A further problem can arise in interfacing due to the higher data transfer speeds. Existing interfaces can be either too complex or incapable of handling the high transfer rate from the drive. That has resulted in a plethora of unstandardised interface designs which need special controllers.

Those disadvantages can, of course, be overcome. Archiving can be accomplished by the addition of a separate, or even an integrated, exchangeable disc unit, or by a tape drive.

High-capacity developments of the tape cartridge drive and a new generation of .5in. tape units using low-cost streaming techniques are becoming available. They have a capacity from 10 to 80Mbyte and to minimise archiving time software techniques are being developed, such as transaction logging.

Transaction logging

With transaction logging, a continual record is kept of each disc update, so that a disc could be recreated by reading the update log. Ironically, the reliability of archiving devices is often considerably lower than that of the Winchester drive.

The interface question is being solved in several ways. For the bigger, more expensive drives the SMD interface has been used in most cases, while for the lower-cost units, both floppy disc-like — but with some critical differences — and a newly-emerging standard are available. When the newer standard has been agreed, it is likely that many of the present drives will be adapted.

Pressure is being applied by both chip manufacturers and potential drive users, who predict low-cost controllers using single-chips within a year's time. The

SMD interface will also be taken down-market as electronics costs continue to fall. In fact, single-chip SMD controllers are a distinct possibility within the next two years.

It is likely that there will be a 10-fold improvement in track density and a five-fold improvement in bit density. To accomplish that, developments of both the disc media and recording heads will be needed, such as plated discs and thin-film deposited heads. The advent of thin-film heads raises the possibility of processing capabilities being included at the head itself.

It is expected that some novel designs will appear in the exchangeable field. Already a high-capacity hybrid drive is on the market, combining a removable 3330 technology cartridge disc with a fixed Winchester module, both units sharing power supplies, electronics and a spindle motor.

Low-cost combinations

Low-cost fixed and exchangeable combinations will use new developments to lift Winchester heads away from the disc surface, allowing its removal. The new design of disc cartridge to permit this is only practical for the largest disc manufacturers.

Any technological innovations will affect all types of disc, although increasing densities will naturally favour

increasingly smaller packages with a mini five-in. Winchester in the not too distant future. Eight-in. drive capacity is expected to top 250Mbyte by 1984 and 100Mbyte on three platters is possible.

Media will be first to change — with cobalt-, chromium- and even ceramic-plated discs progressively replacing ferrous particulate. Plated-disc density starts at 6,000 bit/in. and could reach 18,000 bit/in. by 1982. To take advantage of that capacity, thin-film disc heads will replace ferrite heads, reducing flying heights to 10 μ m. and increasing track density to 1,500/in. by 1986.

Closed loop

The only positioning technology capable of dealing with such densities is interspersed servo track following or embedded servo in which servo information is recorded at the head of each sector on the disc.

Each head operates in a closed loop servo on the track it is seeking. The result is higher positional accuracy, greater utilisation of disc surfaces and disc pack interchangeability over a wide temperature range.

Only Vermont, Digital Equipment and Cii Honeywell-Bull use interspersed servo track following and no-one has yet combined it with Winchester technology, but for the full potential of the lunchbox to be realised, it must happen.

Thin-film technology may be key to improved capacity

In the quest for improved price performance, disc capacity has been increased almost 50-fold for the same final cost to the consumer, by improving discs, heads, electronics, servos, mechanics, codes and error-correction techniques. A further huge jump is expected if a new type of head using semiconductor thin-film technology instead of the traditional ferrite is developed successfully.

MAGNETIC recording on discs, tapes and cassettes is performed by passing a recording head over the surface of the storage media — figure 1. A time varying current is driven into the head which results in a spatial variation of magnetic moment in the media. Such a written track of information is shown in figure 1.

Spatial variation

The spatial variation of magnetic moment along a track can be read by the same or another head which senses the spatial variation of magnetic flux emanating from the media and emits a voltage which can be decoded to retrieve the stored information.

Heads are electro-mechanical devices — figure 2 — which comprise a magnetic core with a gap to perform the writing and reading, a mechanical assembly which critically positions the core with respect to

the storage media and the electrical harness which interfaces to a winding on the magnetic core and plugs into a PCB.

The winding on the core performs as the primary of a transformer. It converts the time-varying current driven into the winding during writing into a time-varying magnetisation in the core. During reading, the winding acts as the secondary of a transformer and converts the time-

Figure 2.

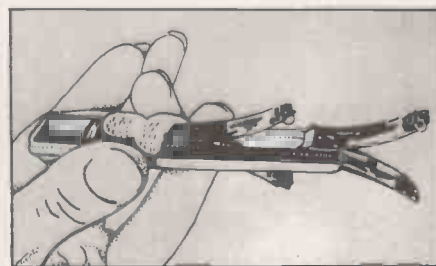

varying magnetisation induced in the core by the storage media into a voltage across the winding.

Flux concentrator

The gap of the core acts as a magnetic flux concentrator during writing. The flux generated in the core by the current in the winding jumps across the core gap. It does that in arcs, some of which intersect the storage media and magnetise it, thus recording information.

During reading, the magnetised variations in the media generate flux changes through the core as they pass the gap which must be shorter than the bit period along the track so that the head can resolve each bit.

Thin-film heads utilise thin-film processing to fabricate the magnetic cores and the turns of the winding around the

(continued on next page)

(continued from previous page)

cores. The processes used are similar to those used in fabricating the conductor metallisation lines on silicon LSI devices. Those processes are very different from those used to fabricate conventional ferrite heads.

Ferrite heads are named after the ferrite ceramic from which the magnetic cores are made. A head contains the magnetic core or gap element within a body called the slider, which is the vehicle to maintain stability and height in relation to the media.

The manufacture of heads has changed over the disc generations but the closest comparison is the 8450 ferrite head process, which is the simplest and has the fewest elements — figure 3. A ferrite I-block — basic slider body — and the C-block — core bar — are bonded together. Glass holds the U together and acts as the non-magnetic gap of the core, separating the poles. The bonded block is diced into slider bodies and shaped to the air-bearing surface to form the slider.

Closest point

In this design, known as a taper/flat air-bearing slider, the flatness and angles must be machined with exacting precision. To define the core, excess material is removed at the rear of the slider body and windings are wrapped around the centre pole. The thickness of the gap at the pole defines the track width and, when flying, it is that tap which is held at the closest point to the media.

Thin-film heads are batch-fabricated on the surfaces of substrate wafers. There are numerous approaches to fabricating the devices.

The cores and winding are fabricated with two layers of aluminium conductors and two layers of magnetic metal. These four metallic layers are patterned by the use of photo-lithography and are separated from each other by insulating layers.

In figure 4, the first pattern of aluminium conductor is shown. The conductors will become part of the windings. The pattern is repeated for each core that will be deposited on a two-in. substrate. Figure 5 shows the patterned bottom

Figure 4.

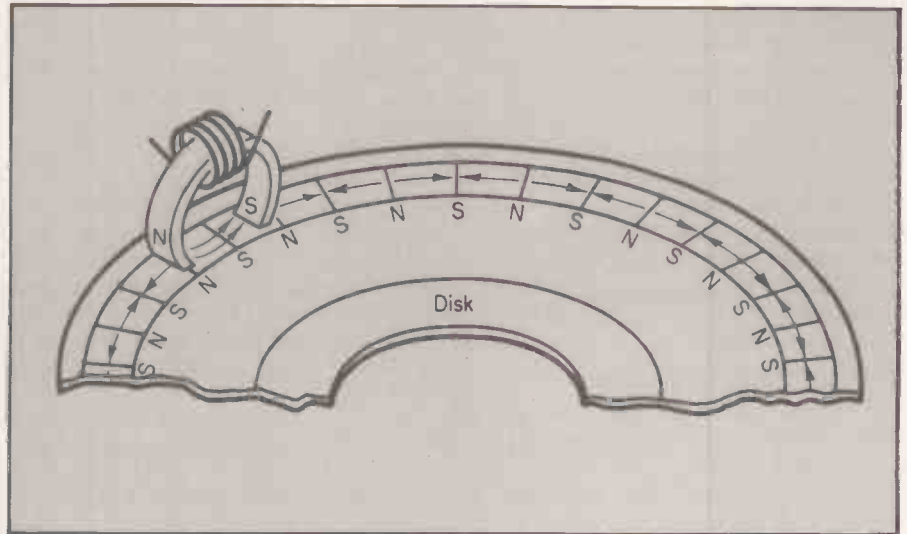
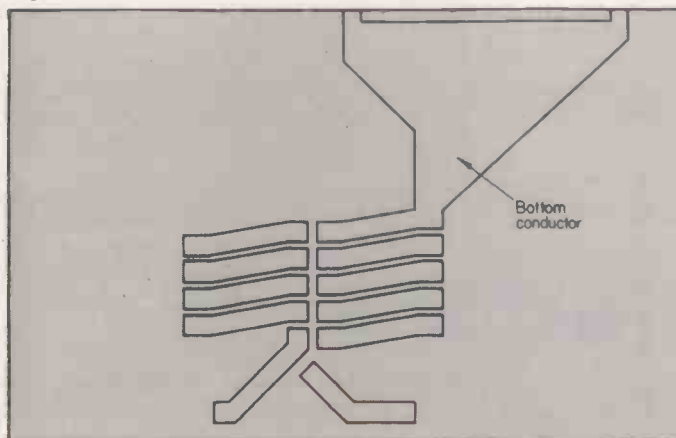

Figure 1.

magnetic film. The patterned second magnetic film — figure 6 — completes the magnetic core.

The insulator deposited between the two magnetic films acts as the gap in the core. Figure 7 shows the final conductor pattern superimposed on the previous layers.

The top conductors contact the first conductor pattern at the white rectangular

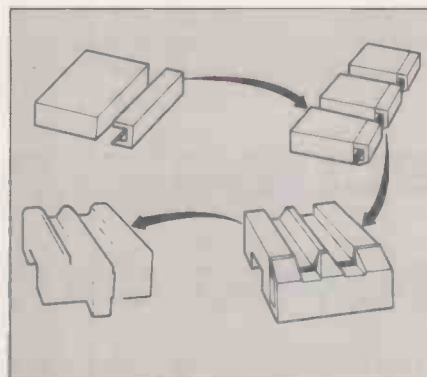
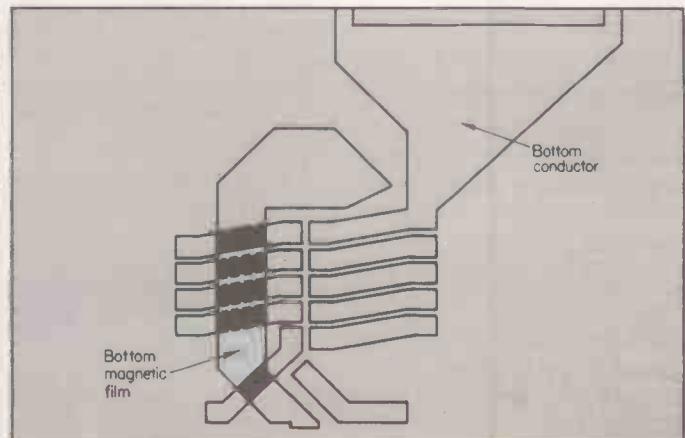

Figure 3.

areas where the insulator layers have been removed. The two layers of conductor form the 11 turns of this core winding. The W in figure 7 is the width of the overlap between the two magnetic layers and is the width of the track the head would record on a storage media passed

Figure 5.



just below the head perpendicular to the picture.

The wafer of deposited heads is sliced into bars and, as in the 8450 ferrite head, further sliced, ground and polished into the slider body with three cores on it which is attached to a head arm assembly.

Thin-film heads have a strong potential for increasing storage density, reducing head costs and improving access time in disc recording. The heads are more efficient, can resolve smaller bits and can perform at higher frequency than ferrite heads. Those improvements result from the much smaller geometries which can be made with thin-film processing technology.

Ferrite cores

Ferrite cores are very difficult to fabricate smaller than $50 \times 50 \times 1$ mil — $1,250 \times 1,250 \times 25$ micron — while thin-film cores can be made as small as $1 \times .2 \times .1$ mil — $25 \times 5 \times 2.5$ micron.

The storage density capability of a disc drive is the result of the complex inter-relationship of all components, not just the head. It is, therefore, impossible to make an accurate estimate of the increase of storage density which results from the use of thin-film heads whose small size allows flexibility of head configurations.

For example, many cores can be

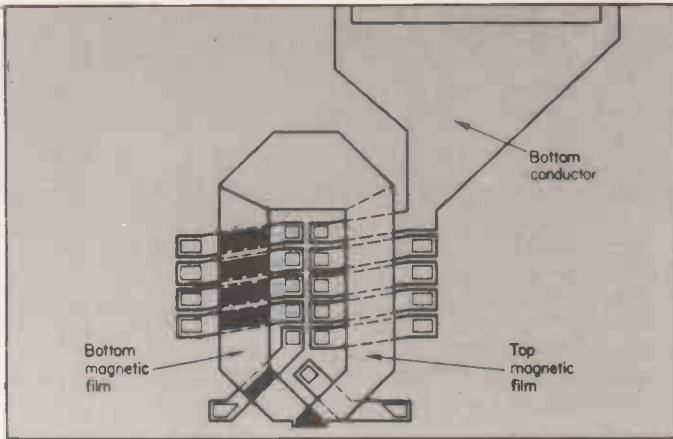

Figure 6.

deposited on the same head arm assembly to make multi-track heads which can be used to increase cylinder capacity, reduce access time and improve throughput.

An effective improvement in access time can be obtained if the number of movements required to access data serially can be reduced. For instance, if there are 10 gaps/slider, a cylinder of data accessible in one movement is 10 times greater than that of a single gap/slider, all other elements being the same.

Also, smaller and lighter slider bodies allow the number of sliders/arm to increase, reducing stroke length which improves access time.

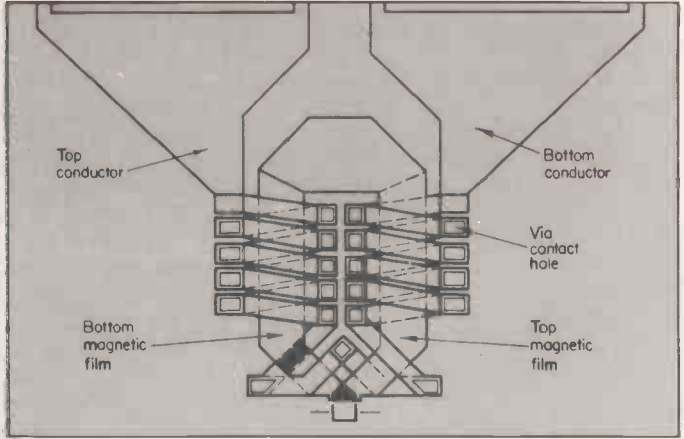

Figure 7.

Thin-film cores at the wafer level are much lower in cost than are ferrite cores. That results in a reduced head-arm assembly cost in those assemblies in which the core is a significant part of the head cost. That is particularly true in the case of multi-core heads such as those used in head-per-track disc products.

Lower reliability

Thin-film heads have been demonstrated to have electrical and magnetic performance superior to that of ferrite heads, but reliability is not as high. The magnetic metallic thin films of the heads are inherently less abrasion- and

corrosion-resistant than ceramic ferrites which are hard oxides.

Head wear is of particular concern in discs like the 8450 where the heads land and take off in contact with the disc during turn-off or start-up. Wear-testing thin-film heads through thousands of such cycles of contact start-stops show that soft metallic films exposed at the flying surface recede from the surface.

That wear is not desirable but may be acceptable. Unlike ferrites, magnetic thin films are subject to corrosion in air. By varying some of the head materials and protecting the device in a number of ways, those disadvantages should be overcome.

Latest techniques maximise floppy-disc performance

The Winchester may be poised in the wings for a take-over, but the floppy will be the standard storage medium for many years — not least for its flexibility. Two-sided, double-density eight-in. discs with double-tracking will yield a capacity of approximately 2.3Mbyte within two years, and five to 10Mbytes are already forecast with improvements in media-production technology.

ALL single-density floppy-disc controllers utilise the double-frequency, DF, encoding technique. The problem is that coding efficiency — the average number of flux transitions per information bit — is poor, requiring a maximum of two flux transitions per information bit for data encoding.

The modified-frequency-modulation, MFM, recording code, on the other hand, requires a maximum of one flux transition per information bit, thus making it possible to double the information bit density for a given recording density — flux transitions/in.

Modified-frequency modulation, along with its cousin, modified-modified-frequency modulation, M²FM, are the two most frequency used recording codes suitable for use in double-density operation with floppy disc drives.

Both permit self-clocking, have a relatively narrow frequency spectrum, and provide a relatively simple hardware

implementation. The encoding algorithms for the two recording codes are as follows: modified frequency modulation: a flux transition is always recorded at the centre of the information bit cell for a binary one. No flux transition is recorded for a binary zero unless it is preceded by another zero, in which case, the flux

transition is provided at the beginning of the information bit cell.

Modified-modified-frequency modulation: a flux transition is always recorded at the centre of the information bit cell for a binary one. A flux transition is recorded at the beginning of an information bit cell

(continued on next page)

Figure 2. Comparison of floppy-disc storage capacities.

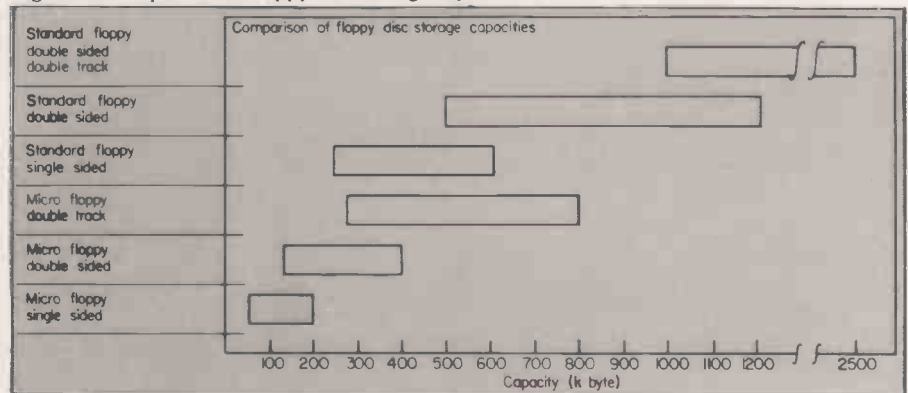

(continued from previous page)

unless the previous information bit cell contained a flux transition — either a 0 or 1 — in which case no flux transition is recorded.

Figure 1 shows the encoded waveforms for MFM and M²FM, along with double frequency for comparison. Although the information bit time, 200 nanoseconds the MFM also M²FM encoding technique, recording density remains unchanged and thus the amount of peak shift at both

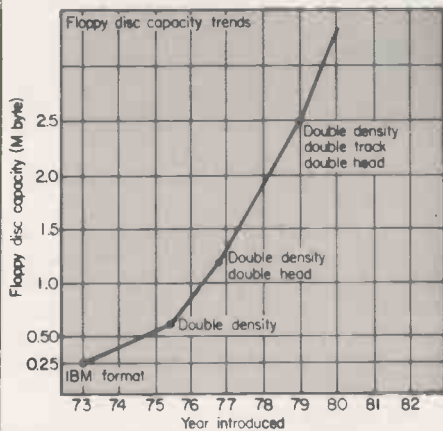
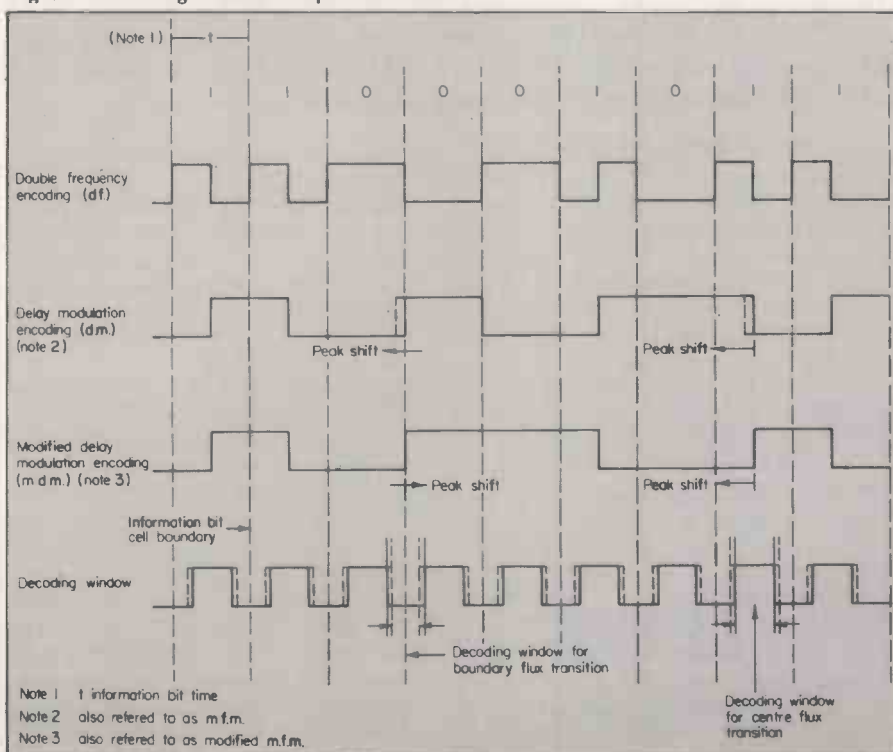

Figure 3. Projection of storage capacity against technique. single and double information bit densities also remains about the same.

The DF, MFM and M²FM recording codes require a decoding window which is one-half of the information bit time. The information bit time at double density is reduced to one-half, 2μs, of its value at single-density, 4μs, and so the attendant decoding window for double density is reduced by one-half — 1μs from 2μs.

The peak shift thus absorbs a greater proportion of the available decoding margin for double-density operation.

Figure 1. Encoding method comparison chart.



The principle of write pre-compensation can be described as a given flux transition being written with a pre-determined time distortion of its true position on the medium if it is expected — depending on the flux transition pattern — to undergo peak shift. Otherwise no write pre-compensation is provided.

The amount of write pre-compensation is normally about one-tenth of the information bit time, 200 nanoseconds and is provided in the direction opposite to that of peak shift.

Data decoding involves identifying each transition in the flux transition sequence read from the disc either as a boundary or a centre transition. That can be achieved by generating decoding windows for boundary and centre flux transitions with the use of a phase locked loop.

Decoding windows

If the boundary and centre flux transitions experience equal amounts of peak shift, the decoding windows for the two types of transition will be symmetrical. However, it is found in practice that in the case of MFM, flux transitions at the centre of an information bit cell experience more peak shift than those at the boundary.

That is demonstrated by applying the principle of superposition of peak shift. Further, it can be shown that the asymmetry is even more pronounced in the case of MFM than in MFM — figure 1. MFM owes its existence to asymmetrical peak shift for boundary and centre flux transitions.

The discussion suggests that, in general, asymmetrical decoding windows can be used to improve the decoding margin for both codes, although the gain is more in



Figure 4. Projection of cost based on an expanding market.

the case of M²FM. Figure 1 illustrates the use of asymmetrical decoding windows (40/60) in data decoding; asymmetrical windows are shown in dashed lines.

Additional gain in decoding margin M²FM is offset by one important disadvantage — it allows the maximum flux

Table 1. Memory cost comparison.

| System | Hardware price (£) per drive | Media cost (£) | Maximum uniform atted capacity | Price per Kbyte |
|---------------|------------------------------|----------------|--------------------------------|-----------------|
| Winchester | 3500 | — | 11MB | £3.18(1) |
| S/S eight | 400 | 4.50 | ½MB | £0.49(22) |
| D/S Eight in. | 800 | 5.50 | 1MB | £0.78(11) |
| S/S 5¼in. | 350 | 2.40 | 200KB | £0.43(55) |
| D/S 5¼in. | 600 | 3.50 | 400KB | £0.63(28) |
| C-12 cassette | 25 | 0.40 | 16KB, at 300 baud | £0.27(688) |

transition separation of 2.5 information bit times. For high-resolution heads, that can cause a differentiator droop problem — shouldering effect.

Excessive differentiator droop in the presence of noise can greatly increase the transient error rate even though the decoding margin might have increased with M²FM. Hardware complexity normally required to eliminate the effect of differentiator droop without affecting the decoding margin is usually not warranted.

From empirical measurements with Pertec double-density floppy disc drives, it has been found that for head resolution values between 45 and 60 percent, MFM with symmetrical decoding windows provides a sufficient decoding margin to achieve the desired error rate, although asymmetrical decoding windows can be used to further improve the decoding margin. For low-resolution heads, however, M²FM will be the better choice.

In table 1, the price per Kbyte is calculated on approximate current prices for 11MB storage. The figure after the price per KB indicates the number of units required to achieve 11MB storage. Clearly, the high price of the Winchester reflects a substantial bonus in convenience — 688 cassettes are going to take up a great deal of storage space.

Buy a microcomputer for under £1,000 and you could be on your own! Unless it's a Commodore PET.



Commodore produce Britain's number one microcomputer. But we don't stop there. We also insist on providing comprehensive support throughout our national dealer network.

Our dealers can examine your needs and demonstrate which hardware and software will suit you best. Their trained engineers are always at hand and a 24-hour field maintenance service is available. Your local dealer can tell you more about the following Commodore Services.

☛ The Commodore PET

The Commodore PET computer range covers everything from the self-contained unit at under £500 to complete business systems at under £2,500.

☛ Commodore Business Software and Petpacks

Our software range covers hundreds of applications. Business software includes Sales and Purchase Ledgers, Accounting, Stock Control, Payroll, Word Processing and more. In addition over 50 Petpacks are available covering such titles as Strathclyde Basic Tutorial, Assembler Development System, Statistics, plus our Treasure Trove and Arcade series of games.

☛ Commodore Approved Products

Compatible products of other manufacturers with Commodore's mark of approval are also available.

☛ Commodore Courses

Commodore offer a range of residential training courses and one day seminars. An excellent start. And when you have installed your system the PET User's Club Newsletter can keep you informed of new ideas and latest developments.

LONDON AREA

Adda Computers Ltd,
W5, 01-579 5845
Advanced Management Systems,
EC2, 01-638 9319
Byteshop Computerland,
W1, 01-636 0647
C.S.S. (Business Equipment) Ltd,
EB, 01-254 9293
Capital Computer Systems,
W1, 01-636 3863
Centralex-London Ltd,
SE13, 01-318 4213
Cream Microcomputer Shop,
HARROW, 01-863 0833
Da Vinci Computer Shop,
EDGWARE, 01-952 0526
L & J Computers,
NW9, 01-204 7525
Home and Business Computers,
E12, 01-472 5107
Merchant Systems Limited,
EC4, 01-353 1464
Metyclean Ltd,
SW1, 01-828 2511
Micro Computation,
M14, 01-822 5104
Micro Computer Centre,
SW14, 01-878 3206
Sumlock Bondain Ltd,
EC1, 01-250 0505
Sumlock Bondain Ltd,
EC4, 01-826 0487
T.L.C. World Trading Ltd,
WC2, 01-839 3894
TOPS TV LTD,
SW1, 01-730 1795

HOME COUNTIES

G. M. Marketing,
ANDOVER, 790922
HSV Microcomputers,
BASINGSTOKE, 62444
MMS Ltd,
BEDFORD, 40601
Elex Systems Ltd,
BRACKNELL, 52929
DWM Direct Data Marketing Ltd,
BRENTWOOD, 229379
Ampicon Micro Systems Ltd,
BRIGHTON, 562163
RUF Computers (UK) Ltd,
BURGESS HILL, 45211
T & V Johnson (Microcomputers
Etc) Ltd, CAMBERLEY, 20446
Cambridge Computer Store,
CAMBRIDGE, 65334
Wego Computers Ltd,
CATERNHAM, 49235
Dataview Ltd,
COLCHESTER, 78811
South East Computers Ltd,
HASTINGS, 426844
Alpha Business Systems,
HERTFORD, 57423
Brent Computer Systems,
KINGS LANGLEY, 65056
Isher-Woods Business Systems,
LUTON, 416202
South East Computers Ltd,
MAIDSTONE, 681263
Micro Facilities Ltd,
MIDDLESEX, 01-979 4546
J. R. Ward Computers Ltd,
MILTON KEYNES 562850
Sumlock Bondain (East Anglia) Ltd,
NORWICH, 26259
T & V Johnson (Microcomputers
Etc) Ltd, OXFORD, 721461
H.S.V. Microcomputers,
SOUTHAMPTON, 22131
Super-Vision
SOUTHAMPTON, 774023
Xitan Systems Ltd,
SOUTHAMPTON, 38740
Stuart R Dean Ltd,
SOUTHEAST-ONS-SEA, 62707
The Computer Room,
TUNBRIDGE WELLS, 41645
Orchard Electronics,
WALLINGFORD 35529

Petatec Ltd,
WOKING, 63901
Oxford Computer Systems,
WOODSTOCK, 811976

MIDLANDS AND SOUTH HUMBERSIDE

Byteshop Computerland,
BIRMINGHAM, 622 7149
CPS (Data Systems) Ltd,
BIRMINGHAM, 707 3866
Camden Electronics,
BIRMINGHAM, 773 8240
Computer Services Midlands Ltd,
BIRMINGHAM, 382 4171
Catlands (Computers) Ltd,
BURTON-ON-TRENT, 812380
Ibek Systems,
COVENTRY, 86449
Jondane Associates Ltd,
COVENTRY, 664400
Davidson-Richards Ltd,
DERBY, 366803
Caddis Computer Systems Ltd,
HINKLEY, 613544
H.B. Computers,
KETERING, 83922
Taylor-Wilson Systems Ltd,
KNOWLE, 6192
Machsize Ltd,
LEAMINGTON SPA, 312542
Office Computer Techniques Ltd,
LEICESTER, 28631
Lowe Electronics,
MATLOCK, 2817
Betos (Systems) Ltd,
NOTTINGHAM, 48108
Byteshop Computerland,
NOTTINGHAM, 40576
Keen Computers Ltd,
NOTTINGHAM, 583254
Tekdata Computing,
STOKE-ON-TRENT, 813631
Systems Micros,
Telford, 460214
McDowell Knaggs & Associates,
WORCESTER, 427077

YORKSHIRE AND NORTH HUMBERSIDE

Ackroyd Typewriter & Adding
Machine Co. Ltd, BRADFORD, 31835
Allen Computers,
GRIMSBY, 40568
Microware Computers Ltd,
HULL, 562107
Microprocessor Services,
HULL, 23146
Holdene Ltd,
LEEDS, 459459

South Midlands Communications Ltd,
LEEDS, 782326
Yorkshire Electronics Services Ltd,
MORLEY, 522181
Computer Centre (Sheffield) Ltd,
SHEFFIELD, 53519
Electronic Services,
SHEFFIELD, 668767
Hallam Computer Systems Ltd,
SHEFFIELD, 663125

NORTH EAST

Dyson Instruments,
DURHAM, 66937
Currie & Maughan,
GATESHEAD, 774540
Wards (Office Supplies) Group,
GATESHEAD, 605915
Elfton Ltd,
HARTLEPOOL, 61770
Fiddes Marketing Limited,
NEWCASTLE, 81517
Newcastle Computer Services,
NEWCASTLE, 615325
Format Micro Centre,
NEWCASTLE, 21093
Tripoint Associated Systems
Consultants Ltd,
SUNDERLAND, 73310

SOUTH WALES AND WEST COAST

Radan Computational Ltd,
BATH, 318483
Computer Corner,
BAYSTON HILL, 4250
Bristol Computer Centre,
BRISTOL, 23430
C.S.S. (Bristol) Ltd,
BRISTOL, 779452
T & V Johnson (Microcomputers
Etc) Ltd, BRISTOL, 422061
Sumlock Tabdown Ltd,
BRISTOL, 26685
Sigma Systems,
CARDIFF, 34869
Office and Business Equipment
(Chester) Ltd, DEESIDE, 817277
A.C. Systems,
EXETER, 71718
Micro Media Systems,
NEWPORT, 59276
J.M. Computer Services Ltd,
NEWQUAY, 2863
Devon Computers,
PAIGNTON, 526303
J.A.D. Integrated Services,
PLYMOUTH 62616
Business Electronics,
SOUTHAMPTON, 738248
Computer Supplies (Swansea),
SWANSEA, 290047

NORTH WEST AND NORTH WALES

Tharstern Ltd,
BURNLEY, 38481
B + B (Computers) Ltd,
BOLTON, 26644
Preston Computer Centre,
PRESTON, 57684
Catlands (Computers) Ltd,
WILMSLOW, 527166

LIVERPOOL

Aughton Microsystems Ltd,
LIVERPOOL, 548 7788
B.E.C. Computers,
LIVERPOOL, 263 5738
Rockcliff Brothers Ltd,
LIVERPOOL, 521 5830

MANCHESTER AREA

Byteshop Computerland,
MANCHESTER, 236 4737
Computastore Ltd,
MANCHESTER, 832 4761
Cytex (U.K.) Ltd,
MANCHESTER, 872 4682
Executive Reprographic Ltd,
MANCHESTER, 228 1637
N.S.C. Computer Shops Ltd,
MANCHESTER, 832 2269
Sumlock Electronic Services
(Manchester) Ltd,
MANCHESTER, 834 4233
Professional Computer Services Ltd,
OLDHAM, 624 4065
D. Kipping Ltd,
SALFORD, 834 6367
Automated Business Equipment Ltd,
STOCKPORT, 061-432 0708

SCOTLAND

Holdene Microsystems Ltd,
EDINBURGH, 668 2727
Microcentre,
EDINBURGH, 556 7354
Aethroli Consultancy Services,
GLASGOW, 641 7758
Byteshop Computerland,
GLASGOW, 221 7409
Robox Ltd,
GLASGOW, 221 5401
Mac Micro,
INVERNESS, 712203
Thistle Computers,
KIRKWALL, 3140

IRELAND

Softech Ltd,
DUBLIN, 784739
Medical & Scientific Computer
Services Ltd, LISBURN, 77533

To: Commodore Information Centre,
360 Euston Road, London W1 3BL. 01-388 5702

Please send me further information about the Commodore PET.

Name

Position

Address

Intended application PC D10

Do you own a PET? YES NO

commodore

This list covers dealers participating in our advertising.

• Circle No. 177

Frieze Patterns

MANY will be familiar with the computer simulation, Life, which was invented by John Conway, probably the leading U.K. expert in the field of recreational mathematics. When I was a student, Conway showed me a kind of numerical version of Life which he called Frieze Patterns.

As in Life, the outcome of a Frieze Pattern is derived from its initial position

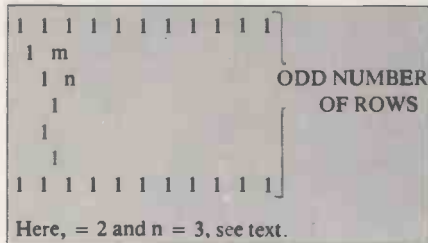
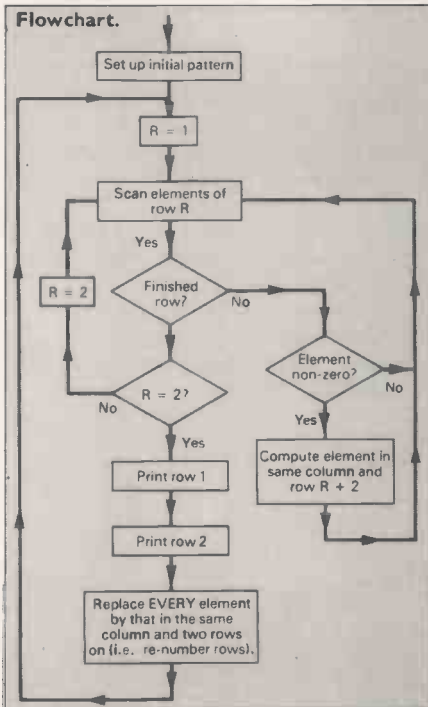

Figure 1. Typical starting position.

by the application of simple rules. Although, in this case, the result is entirely predictable — it is the manner in which the result is obtained which is both interesting and surprising.

To draw a Frieze Pattern, start with two



infinite rows of 1s an odd number of lines apart and join them with a chain of 1s in any formation you like, without breaking the chain — figure 1. The rest of the pattern is completed according to the rule:

$$a + d = b + c \text{ where } ad + 1 = bc$$

Thus, the 'm' in figure 1 is found by: $1 \times 1 + 1 = 1 \times m$ so that $m = 2$

similarly, $n = 3$ and so on. As you start to fill in the pattern, be ready for a surprise — the answers are always whole numbers.

The reader is now urged to draw a pattern to verify that amazing fact. However big the numbers become, and, if you start with the rows too far apart they will become very big, the result always divides-out.

As the process continues, the numbers begin to become smaller and you will eventually reach your original pattern of 1s — only reversed, figure 2. From here, the pattern repeats itself, thus justifying the name of Frieze Patterns.

Because the rules are so simple, it is a comparatively easy task to program a computer to draw Frieze Patterns and a suggested flowchart and program in Basic are given.

Those who have access to a printer will find that Frieze Patterns make great mathematical wallpaper. Others might like to discover exactly why the process works — it is not so easy.

For obvious reasons, the pattern is printed vertically rather than horizontally and 'WIDTH' (line 110) refers to the total width of the pattern, including the two rows of 1s.

The starting position is entered as a string, PF consisting of Us for up and Ds for down — note that it is not necessary to place the first 1, but all the rest must be placed correctly relative to it.

The method of inputting the initial configuration, which occupies lines 100 - 280 of the program, is rather clumsy but, in practice, easy to use.

Lines 430 - 460 re-number the rows so

that only W are remembered. In fact, as soon as a row is printed, it is forgotten. □

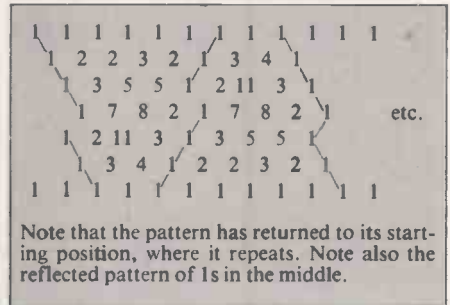
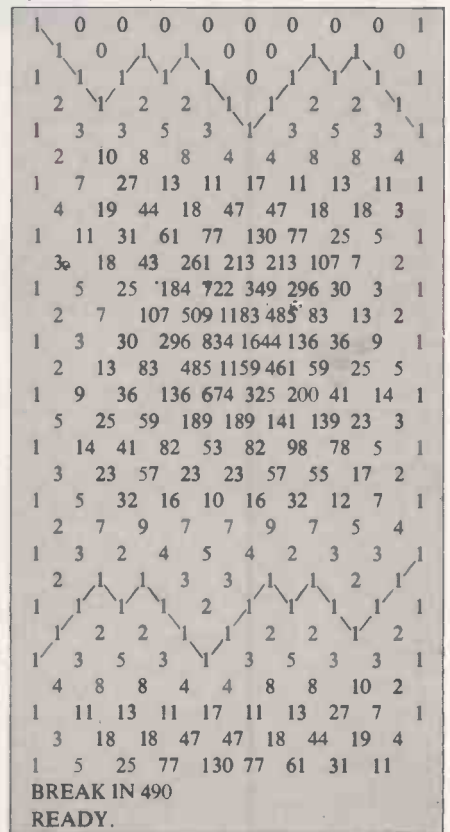

Figure 2. Frieze pattern of figure 1 completed.

Typical frieze pattern.



```

100 PRINT"3FRIEZES"
110 INPUT"WIDTH (WD) ";w
120 DIMA(W+2,w)
130 FORR=1TOW+2STEP2
140 A(R,1)=1:A(R,W)=1
150 NEXT
160 PRINT"YOUR PATTERN(W=3; ITEMS)";
170 INPUTP:IFLEN(P)=W-3THEN190
180 PRINT"INCORRECTLY SFT":GOTO170
190 R=2:A(2,2)=1:FLC=3TOW-1
200 AS=MID(P,C-2,1)
210 IFA=C>"U"THENR=R+1:GOTO270
220 IFR>1THENR=R-1:GOTO270
230 A(2,C)=1:FLY=2TOC-1
240 FRY=WTOSTEP-1
250 IFA(X,Y)=1THENA(Y,Y)=0:A(Y+2,Y)=1
260 NEXTY,Y=R+2:GOTO280
270 A(R,C)=1
280 NEXTC
290 REM NOW COMPUTE PATTERN
300 FORR=1TO2
310 FORC=2TOW-1
320 IFA(R,C)=0THEN340
330 A(R+2,C)=(A(R+1,C-1)*A(R+1,C+1)+1)/A(R,C)
340 NEXTC,R
350 R=1:PRINTR;" ";
360 FORC=3TOW-2STEP2
370 GOSUB480
380 NEXT:PRINTR;"5"
390 R=2:PRINT" ";
400 FORC=2TOW-1STEP2
410 GOSUB480
420 NEXT:PRINT"5"
430 FORR=1TOW
440 FORC=1TOW
450 A(R,C)=A(R+2,C)
460 NEXTC,R
470 GOTO300
480 PRINTA(R,C);" ";
490 IFA(R,C)<10THENPRINT" ";
500 RETURN
READY.
    
```

Queues at Millbank!

for



Qume Sprint 5 Daisywheel Printers.

These high quality 45/55 KSR and RO printers are now available at attractive trade prices — from **£1389.00** (excl. VAT)
No other daisywheel printer offers this level of quality, performance and flexibility.

TSE Daisywheel print wheels allow a choice of over 50 different type faces.

HIGH PERFORMANCE SYSTEMS TOO!

Word processing and a wide range of general business functions at highly competitive OEM prices

Ring or write for details:

MILLBANK COMPUTERS LIMITED

East Lane, Kingston upon Thames, Surrey Telephone: 01-549 7262

• Circle No. 178

Why get your PET from HSV

Because HSV are an established and expanding computing services company in operation since 1973. We offer microcomputers backed by systems advice, after-sales support and maintenance, from specialised computer centres.

Our interest does not stop at the sale of a PET — HSV assure full back-up support:-

- in-house analysts and programmers
- our own engineers operating from 2 service centres
- a range of specialist systems for business, industry and education
- instruction manuals, programme cassettes, add-on equipment and all other supplies

For Commodore PET 3000 and the new larger 8000 Series.

That's why!

HSV Limited, 22 Southampton Street, Southampton, Hants. Tel. (0703) 22131, and
May Place, Basingstoke, Hants. Tel. (0256) 62444.



• Circle No. 179

Study the TRS-80 in Cambridge

For centuries now Cambridge has attracted students for learning and research. Following in the tradition, Cambridge Computer Store — the most active Tandy franchise dealer in the U.K. — offers you the opportunity to study in depth the full range of TRS-80 hardware and software. On demonstration in the Store are the top-selling Model 1 and the new, exciting Model II plus a wide range of peripherals: from a minimal system (at only £251) to fully expanded configurations — all immediately available.

Visit us in Cambridge and study the TRS-80. With our help you're sure to graduate with honours!

Cambridge Computer Store

1 Emmanuel Street Cambridge CB1 1NE
Telephone: (0223) 65334/68155

Apple : Cromemco : Hewlett-Packard : Horizon : Pet : Acorn : CompuKit : Sinclair : Houston : Infoton : Centronics : Qume : Word-Star

• Circle No. 180

TCL PASCAL

Standard PASCAL
with P-code interpreter and linker,
following the ISO/BSI working draft.
Compiler operates in two modes:

Resident in RAM—makes
PASCAL as easy to learn as BASIC

Disc mode—with full set of
PASCAL commands.

Many enhancements to standard
PASCAL. Fully validated. Runs in
32K of RAM.

● TCL PASCAL for CP/M and PET is available now
at £120 plus VAT including Manual. Carriage paid.

● TCL PASCAL Manuals are available at £9.50 each.
Carriage paid.

TCL SOFTWARE

We mind our language!

TCL SOFTWARE
59/61 THEOBALD'S ROAD, LONDON WC1.
TEL: 01-405 5240

©TCL PASCAL is copyright of TCL Software. OEM licences available.

®
CP/M

Compatible with all
systems. IBM format on 5"
or 8" discs.

Manual—TCL PASCAL
for CP/M.

Runs on TUSCAN,
TRITON, 380Z, TEI, TRS80
computers.

*
PET

Unique features include
interface to PET BASIC and
clock.

Available now for PET 3032
on 5" disc.

Manual—TCL PASCAL
for PET.

*Available from TCL SOFTWARE and all Commodore
PET dealers now.

I am interested in the TCL PASCAL compiler. Please send me.

The TCL PASCAL Manual for PET CP/M* at £9.50

The TCL PASCAL Manual and DISC for PET CP/M* at £138.

*Delete as necessary and specify 5" or 8" disc for CP/M.

NAME _____

ADDRESS _____

TELEPHONE _____

• Circle No. 181

PRACTICAL COMPUTING October 1980

RAIR BLACK BOX
MICROCOMPUTER

POWER

LOAD

RESET

RAIR MICROCOMPUTER
BLACK BOX

*Discover the secrets of
the RAIR Black Box*

Britain's first computer kit.

The Sinclair ZX80.

£79.95

Price breakdown

ZX80 and manual: £69.52

VAT: £10.43

Post and packing FREE

Please note: many kit makers quote VAT-exclusive prices.

You've seen the reviews... you've heard the excitement... now make the kit!

This is the ZX80. 'Personal Computer World' gave it 5 stars for 'excellent value.' Benchmark tests say it's faster than all previous personal computers. And the response from kit enthusiasts has been tremendous.

To help you appreciate its value, the price is shown above with and without VAT. This is so you can compare the ZX80 with competitive kits that don't appear with inclusive prices.

'Excellent value' indeed!

For just £79.95 (including VAT and p&p) you get everything you need to build a personal computer at home... PCB, with IC sockets for all ICs; case; leads for direct connection to a cassette recorder and television (black and white or colour); everything!

Yet the ZX80 really is a complete, powerful, full-facility computer, matching or surpassing other personal computers at several times the price.

The ZX80 is programmed in BASIC, the world's most popular computer language for beginners and experts alike.

The ZX80 is pleasantly straightforward to assemble, using a fine-tipped soldering iron. It immediately proves what a good job you've done: connect it to your TV... link it to an appropriate power source... and you're ready to go.

Your ZX80 kit contains...

- Printed circuit board, with IC sockets for all ICs.
- Complete components set, including all ICs—all manufactured by selected world-leading suppliers.
- New rugged Sinclair keyboard, touch-sensitive, wipe-clean.
- Ready-moulded case.
- Leads and plugs for connection to domestic TV and cassette recorder. (Programs can be SAVED and LOADED on to a portable cassette recorder.)
- FREE course in BASIC programming and user manual.

Optional extras

- Mains adaptor of 600 mA at 9 V DC nominal unregulated (available separately—see coupon).
- Additional memory expansion boards allowing up to 16K bytes RAM. (Extra RAM chips also available—see coupon).

*Use a 600 mA at 9 V DC nominal unregulated mains adaptor. Available from Sinclair if desired (see coupon).

The unique and valuable components of the Sinclair ZX80.

The Sinclair ZX80 is not just another personal computer. Quite apart from its exceptionally low price, the ZX80 has two uniquely advanced components: the Sinclair BASIC interpreter, and the Sinclair teach-yourself BASIC manual.

The unique Sinclair BASIC interpreter offers remarkable programming advantages:

- Unique 'one-touch' key word entry: the ZX80 eliminates a great deal of tiresome typing. Key words (RUN, PRINT, LIST, etc.) have their own single-key entry.
- Unique syntax check. Only lines with correct syntax are accepted into programs. A cursor identifies errors immediately. This prevents entry of long and complicated programs with faults only discovered when you try to run them.
- Excellent string-handling capability—takes up to 26 string variables of any length. All strings can undergo all relational tests (e.g. comparison). The ZX80 also has string input-to request a line of text when necessary. Strings do not need to be dimensioned.
- Up to 26 single dimension arrays.
- FOR/NEXT loops nested up to 26.
- Variable names of any length.
- BASIC language also handles full Boolean arithmetic, conditional expressions, etc.
- Exceptionally powerful edit facilities, allows modification of existing program lines.
- Randomise function, useful for games and secret codes, as well as more serious applications.
- Timer under program control.
- PEEK and POKE enable entry of machine code instructions, USR causes jump to a user's machine language sub-routine.
- High-resolution graphics with 22 standard graphic symbols.
- All characters printable in reverse under program control.
- Lines of unlimited length.

Fewer chips, compact design, volume production—more power per pound!

The ZX80 owes its remarkable low price to its remarkable design: the whole system is packed on to fewer, newer, more powerful and advanced LSI chips. A single SUPER ROM for instance, contains the BASIC interpreter, the character set, operating system, and monitor. And the ZX80's 1K byte RAM is roughly equivalent to 4K bytes in a conventional computer—typically storing 100 lines of BASIC. (Key words occupy only a single byte.)

The display shows 32 characters by 24 lines. And Benchmark tests show that the ZX80 is faster than all other personal computers.

No other personal computer offers this unique combination of high capability and low price.

Z80 A microprocessor—new, faster version of the famous Z-80 microprocessor chip, widely recognised as the best ever made.

Sockets for TV, cassette recorder, power supply.

SUPER ROM.

Clock.

Rugged, flush, Sinclair keyboard.

UHF TV modulator.

RAM chips.

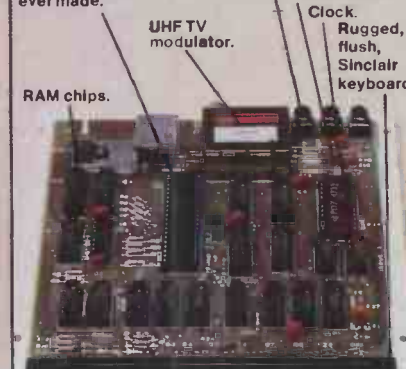

Complete

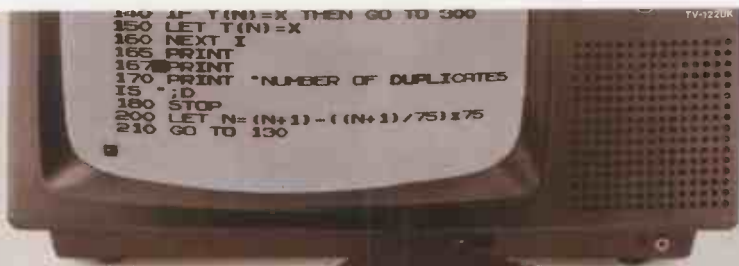

The Sinclair teach-yourself BASIC manual.

If the specifications of the Sinclair ZX80 mean little to you – don't worry. They're all explained in the specially-written 128-page book free with every kit! The book makes learning easy, exciting and enjoyable, and represents a complete course in BASIC programming – from first principles to complex programs. (Available separately – purchase price refunded if you buy a ZX80 later.) A hardware manual is also included with every kit.

The Sinclair ZX80. Kit: £79.95. Assembled: £99.95. Complete!

The ZX80 kit costs a mere £79.95. Can't wait to have a ZX80 up and running? No problem! It's also available, ready assembled and complete with mains adaptor, for only £99.95.

Demand for the ZX80 is very high: use the coupon to order today for the earliest possible delivery. All orders will be despatched in strict rotation. We'll acknowledge each order by return, and tell you exactly when your ZX80 will be delivered. If you choose not to wait, you can cancel your order immediately, and your money will be refunded at once. Again, of course, you may return your ZX80 as received within 14 days for a full refund. We want you to be satisfied beyond all doubt – and we have no doubt that you will be.

sinclair
ZX80
Science of Cambridge Ltd

6 Kings Parade, Cambridge, Cambs., CB2 1SN.
Tel: 0223 311488.

| Quantity | Item | Item price £ | Total £ |
|----------|---|-----------------|------------|
| | Sinclair ZX80 Personal Computer kit(s). Price includes ZX80 BASIC manual, excludes mains adaptor. | £79.95 | |
| | Ready-assembled Sinclair ZX80 Personal Computer(s). Price includes ZX80 BASIC manual and mains adaptor. | £99.95 | |
| | Mains Adaptor(s) (600 mA at 9 V DC nominal unregulated). | 8.95 | |
| | Memory Expansion Board(s) (each one takes up to 3K bytes). | 12.00 | |
| | RAM-Memory chips – standard 1K bytes capacity. | 16.00 | |
| | Sinclair ZX80 Manual(s) (manual free with every ZX80 kit or ready-made computer). | 5.00 | |
| | | TOTAL | £ |

NB. Your Sinclair ZX80 may qualify as a business expense.

Enclose a cheque/postal order payable to Science of Cambridge Ltd for £ _____
Please print
Name: Mr/Mrs/Miss _____
Address _____

PC10

• Circle No. 183

Base 2 MODEL 800MST



ONLY
£359 + VAT

80 COLUMN HIGH PERFORMANCE IMPACT PRINTER

- suitable for most Micros.

JUST LOOK AT THESE STANDARD FEATURES:-

*RS-232, 20mA, IEEE 488 and Centronics I/O
*15 Baud rates to 9,600 *60 lines per minute - Bidirectional *6 print densities 60, 72, 80, 96, 120 or 132 Chr/line *Self test switch *96 Chrs. ASC II Standard *Auxilliary User Defined Ch. set *Tractor and fast paper feed/graphics *2k Buffer *Accepts 8 1/2" max. paper pressure feed and 9 1/2" max. paper tractor feed.

NEW 80 COLUMN 32k Pet

ONLY £825 + VAT

Standard Large Keyboard

16k - £499 + VAT

32k - £599 + VAT

Very popular for home & business, using 8k Microsoft Basic in ROM. Both models are with new improved keyboard and all with green screen. Extra Cassette Deck £55 + VAT



Compukit UK 101 DISC DRIVES

with up to 32k RAM expansion

free games disc



*9 Digit extended Basic

*Plugs straight into 8k Compukit requires no hardware mods. (5v.5A required for 610)

610 Expansion (8k) ONLY £159 + VAT

Disc Drive with DOS ONLY £285 + VAT

EXATRON TRS80 Stringy Floppy

COMBINES ECONOMY OF CASSETTE WITH SPEED & RELIABILITY OF DISC (TRS80 expansion interface not needed)

16k loads in approx. 24 secs. - Wafers to 75ft (48k approx.)

ONLY £149 + VAT
PSU £5.50 +VAT

Stringy Floppy with 10 Wafers (Tapes) BUS EX. 2 for 1. Machine Lang. Monitor



Coming soon Apple & Pet version

Oki Microline 80

Small, light, quiet matrix printer.

40, 80 or 132 cols.

6 or 8 lines per inch.



96 ASC II + 64 graphics character set with Centronics compatible interface

£425 + VAT
RS232 version available.

NEC Spinwriter

- for the professional word processing system

£1390 + VAT



Model 5510-R5232, current loop, Centronics 8bit par. NEC's high quality printer uses a print "thimble" that has less diam. and inertia than a daisy wheel. Giving a quieter, faster more reliable printer that can cope with plotting and printing (128ASC II chs.) with up to 5 copies, friction or tractor fed. 55Chrs/sec.

Ohio Superboard II & Challenger IP

- the no fuss start to Micro's.

* Ready Built *8k Microsoft in ROM, 6 digit floating point basic plus full features.



NEW 48 X 32 SCREEN

All 50Hz operation

- SUPERBOARD II £159 + VAT
- SUPERBOARD II (48x32). £199 + VAT
- POWER SUPPLY 5v.3A. £27 + VAT
- CASE £27 + VAT
- CHALLENGER 1P £209 + VAT
- CHALLENGER 1P (48x32) £249 + VAT

(Superboard is used in Challenger)

Video Genie - based on TRS80

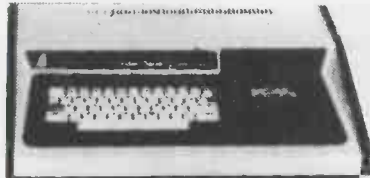

Utilises Z80, 12k level Basic, 16k RAM, Integral Cassette Deck, UHF O/P, all TRS80 features. NOW ONLY £329 + VAT

Ohio Challenger C20EM

- workhorse for industrial & business systems.

* 48k RAM * Dual 8" disc drives with OHIO OS-654 operating based on OSI. Bus. card options available.

£1750 + VAT



Qume Sprint 5

- Daisywheel quality printer.



50 different type styles including APL, Scientific symbols and International character sets.

43 Qume defined commands for operating control. Built in diagnostics. Serial or parallel. £1595 + VAT

Rochester Dynawriter

- turns your electric typewriter into a word processor on TRS80.

PET and APPLE versions available



£319 + VAT

Comes complete with solenoid pack, PSU interface board and software. TRS80 version (No exp. int. needed)

ZT Driving Computer



*MPG instant *MPG average *Gals. used since fillup *Miles to empty *Elapsed time *Time to empty *Time on trip *Miles on trip £77.50 + VAT

SOFTY

INTELLIGENT EPROM PROGRAMMER

Connects directly to TV. Develop, Copy, Burn, Verify 2708, 2716 and with modification 2516

Ideal development tool can connect via RS232 or connect into system in order and assume transparent firmware space

ONLY £120 + VAT Built and tested £100+ VAT Kit £20+VAT Built Power Supply



NOW ON SHOW IN THE SCIENCE MUSEUM

Mighty Micro

Please add V.A.T. at 15%. Carriage extra, will advise at time of order. Official orders welcome. 61 NEW MARKET SQUARE, BASINGSTOKE, HANTS. RG21 1HWA Tel: 0256 56417 & 26620 also in association with O. S. & COMPUTERS, ESHER, SURREY. Telephone: 0372 62071 Buy in confidence. If on receipt of your order the goods do not meet with your satisfaction, return within 7 days for full refund. Credit facilities arranged.

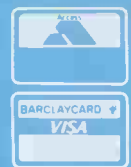

for a Mighty good deal !!!

• Circle No. 184



MICRODIGITAL **are** **the Experts!**

Wide Range

Competitive prices

All plugs and leads free

12 months guarantee

Access/Barclaycard/Stereo Club

Free Delivery

Specialisation

14 days credit

Fast friendly service

Freepost

A Laskys Company

All equipment tested before despatch

**Turn to the back page of this supplement
your chance to win**

£1000

exclusively to spend at Microdigital



LASKYS
Company



Office:
14 CASTLE STREET,
LIVERPOOL L2 0TA.
Registered in England No. 1375098

Retail Premises at:
25 BRUNSWICK STREET,
LIVERPOOL L2 0PJ.
Tel:- 051-227 2535/6/7



Sharp Pocket Computer

A genuine advance in technology.

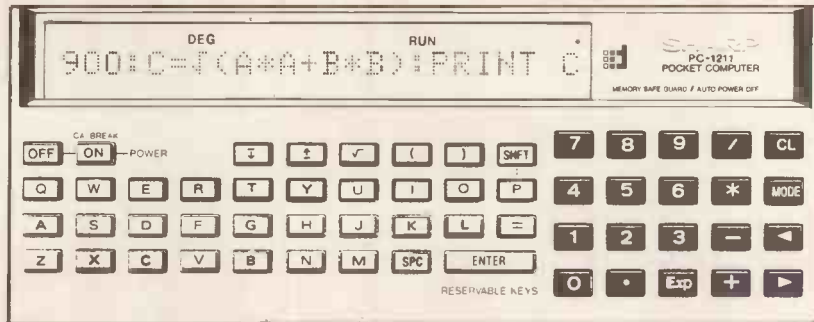

Adoption of Basic Language

For Programming, the PC-1211 employs the BASIC language, used widely from beginners to professionals. This simple programming method can easily be carried out by referring to the flow chart. Moreover, formulas can be entered as they are normally written. These innovative functions are designed with ease of operation in mind.

The PC-1211 also serves as an ideal "stepping stone" to professional computers.

Dot matrix display – up to 24 digits with rolling writer.

Characters as well as numerals are displayed with the dot matrix display enabling the operator, to communicate with the unit. The BASIC language can be used to its full potential. The display panel makes it possible to display portions of the program (line by line) visual instruction asking for data and showing calculation results.

Program capacity 1424 steps. 26 memories with memory safe guard.

The PC-1211 has a large memory capacity in spite of its slim, compact body. Due to the memory safe guard circuit, information in memory is maintained even after the power is turned off.

Programming is by an efficient "one-command, one-step" system. According to your needs, steps can also be used as a memory.

(8 steps is equivalent to 1 memory).

Reservable key and definable key systems.

*The reservable key system makes it possible to reserve a key

for a function or command which is used frequently. It can easily be recalled by the touch of a key when putting in a formula either during manual calculation or programming.

*The definable key system defines 18 programs for each key. Whenever you need a certain program, you can recall and run it with the touch of the proper key.

Programs and data can be saved in and loaded from a tape recorder.

The cassette tape recorder can be used as an external memory device.

(Cassette interface CE-121 is optional)

By saving programs or data on a cassette tape, the information can be loaded whenever necessary. It is also possible to search the saved program data automatically by file name or load it for use during the program calculation.

Other features

- * Long-life operation, Auto power-off function.
- * Playback function enables correction by displaying the formula with a single touch of a key.
- * Effective tone function is designed to identify the program. (A beep sound can be input during programming.)

| Price | Nett | Vat | Total |
|---------------------------|-------|-------|-------|
| PC-1211 Pocket Computer | 84.00 | 12.60 | 96.60 |
| CE-121 Cassette Interface | 12.00 | 1.80 | 13.80 |

Specifications SHARP POCKET COMPUTER

| | | | |
|-------------------------------|---|-----------------------------|--|
| Model: | PC-1211 | Editing functions: | and logical calculations. Cursor shifting (>, <) Insertion (INS) Deletion (DEL) Line up and down (↑, ↓) |
| Number of calculation digits: | 10 digits (mantissa) + 2 digits (exponent) | External memory Function: | By using the optionally available cassette interface (CE-121), program, reserve program, and data memory can be saved or loaded to or from cassette tape recorder. |
| Calculation system: | According to mathematical formula (with priority judging function) | Memory protection: Display: | CMOS battery back-up 24-digit alphanumeric dot matrix liquid crystal display. CMOS LSI, ETC. |
| Program system: | Stored system | Component: Power supply: | ● Alkaline manganese battery (LR-44) x 3 (built-in) Approx. 100 hours ● Silver oxide battery (G-13 or S15 type) x 3 Approx. 300 hours |
| Program language: | BASIC | Power consumption: | 4.5V ... (DC): 0.009W 4.5V ... (DC): 0.011W (with CE-121) |
| Capacity: | Program memory; Max. 1424 steps Data memory; Fixed memory ... 26 pcs. Flexible memory (common) 178 pcs. | Operating temperature: | 0°C 40°C (32°F 104°F) |
| Stack: | Reserve memory; Max. 48 steps (reserve PROGRAM: Max. 18 kinds) Input buffer; 80 characters | Dimensions: | 175(W) x 70(D) x 15(H)mm 6-7/8"(D) x 19/32"(H) |
| | For data; 8 stacks For function; 16 stacks (in parentheses, 15 levels) | Weight: | Approx. 170g (0.37 lbs.) |
| | For subroutine; 4 stacks For FOR-NEXT statement; 4 stacks | Accessories: | Hard case, battery x 3 (built-in), applications manual, beginner's textbook for "BASIC", template x 2 |
| Calculations: | Four arithmetic calculations, power calculation, trigonometric and inverse trigonometric functions, logarithmic and exponential functions, angular conversion, extraction of square root, sign function, absolutes, integers, | | |



Office:
14 CASTLE STREET,
LIVERPOOL L2 0TA.
Registered in England No. 1375098

Retail Premises at:
25 BRUNSWICK STREET,
LIVERPOOL L2 0PJ.
Tel:- 051-227 2535/6/7

Sharp MZ-80K

The quality single unit computer.



SHARP

New Low prices

| | Net | Vat | Total |
|----------------------------|--------|--------|--------|
| MZ-80K Computer 48K RAM | 500.00 | 75.00 | 575.00 |
| MZ-80FD dual disk drive | 780.00 | 117.00 | 897.00 |
| MZ-80P3 printer | 500.00 | 75.00 | 575.00 |
| MZ-80I/O interface unit | 84.00 | 12.00 | 96.60 |
| MZ-80FDK extra disk drives | 680.00 | 102.00 | 782.00 |
| MZ-80T20C machine language | 18.00 | 2.70 | 20.00 |
| MZ-80TU assembler | 38.00 | 5.70 | 43.70 |

Not a Kit

Works the same day you buy it.

Japanese

The same quality they have put into cars and Hi-Fi.

Single Unit

No trailing leads and wires

Z80

More registers and instructions than other processors

Tape Basic

You don't get left with obsolete ROMS

Tape counter

Know where you are on the tape.

Sound

Built-in music synthesiser with 3 Octaves.

Fast loading

Cassette interface runs at 1200 bps.

Other features - 79 keyboard up to 48K RAM, on screen editing, real time clock 256 different characters, 10 inch video display 80 x 50 bit mapped graphics.

The Basis of System Expansion Interface Unit MZ-80I/O

The MZ-80I/O interface unit connects the central processing unit (CPU) with other terminal units and makes possible further expansion of the system.

The interface unit can hold up to five different interface cards and utilizes its own built-in power source.

Fast and Legible Printing of Characters and Graphics Dot Printer MZ-80P3

By parallel data input, the MZ-80P3 prints characters on ten-inch wide paper, 80 characters to the line, at a speed of approximately 1.2 lines per second. The "tractor feed" system prevents paper slipping and produces clear print at high speed. A variety of characters can be printed by the MZ-80P3, including both upper and lower case letters, numerals and graphics.

Large Memory Capability in a Compact Unit Floppy Disc MZ-80FD

Memory capacity up to 280K bytes can be accessed quickly and easily from dual driven standard 5.25 inch floppy discs.

Specifications

MZ-80I/O

Interface system: Parallel Interface
Signal: TTL level
Usable interface card: Up to 5 sheets
Printer interface card, Floppy Disk interface card, Colour display interface card, Universal interface card, etc.

Power consumption: 45W
Power Supply: Local voltage, 50Hz
Operating temperature: 0 to 35°C
Storage temperature: -15 to 60°C
Dimensions: 205(W) x 320(D) x 130(H)(mm)
Weight: 5kg

MZ-80FD

Memory capacity: 143K bytes/drive (286K bytes/unit)
No. of tracks: 70
No. of sectors: 16 (per track)
Working conditions: 4 to 25°C, 28 to 80% (relative humidity)
Rated voltage: Local Voltage, 50Hz
Power consumption: 40W
Outer dimensions: 205(W) x 320(D) x 200(H)(mm)
Weight: 7.9kg

Option:

Floppy interface card: MZ-80FI/O included in price
Disk BASIC: MZ-80FMD included in price
Flat cable for connection: MZ-80F15, included in price

MZ-80P3

Printing method: Serial dot matrix method
Feed method: Tractor feed method
Printing capacity: 80 characters/line
40 characters/line (Double size character display)

Kinds of printed characters: 226 kinds excluding the space code
6 x 7 dots
Character make-up: 12 x 7 dots (Double-size character display)

Width: 2.2mm Height: 3.1mm
Size of character: About 1.2 lines/sec (at 25°C)
Line-to-line space: 2.54mm (in normal mode)

Head sweep direction: Left Right
Operation switches: Power supply & paper feeding
Interface: Conforming to Bandminton interface

Print recording paper: (1) Kind: Fanfold paper
(2) Size: (Width) 102 to 254mm (4 to 10 inches)
Note: In the case of printing 80 characters per line, use paper of 254mm width. Copy possible

Ink ribbon: (1) Colour: Single (Black)
(2) Size: 13mm(W) x 11,000mm(L)
(3) Life: About 2 million letters

Local voltage, 50Hz
Power supply: 85W
Power consumption: 5 to 40°C
Working temperature: 10 to 80% (No dew-condensation)
Working humidity: -20 to 50°C
Storage temperature: 5 to 85% (No dew-condensation)
Storage humidity: 410(W) x 385(D) x 198(H)(mm)
Outer dimensions: 10.6kg
Weight:

*Specifications and design subject to change without notice.

Office:
14 CASTLE STREET,
LIVERPOOL L2 0TA.
Registered in England No. 1375098

Retail Premises at:
25 BRUNSWICK STREET,
LIVERPOOL L2 0PJ.
Tel:- 051-227 2535/6/7





Apple II

sets the standards.

Free with every Apple II
 ★ 32K bytes of extra RAM
 ★ Black and white Modulator.

Why Apple II

Apple Computer has built a reputation for advanced design with innovations like:

- Colour Graphics
- High Resolution Dot Graphics
- Sound Synthesis
- Analog Inputs

Apple understands product support: documentation, software, accessories; and the system capacity to take advantage of them. Additionally, more than 60 other companies produce hardware and software products for Apple II, making the system an industry standard.

The Apple II Computer features

Apple II is a state-of-the-art personal computer. It is not a toy or a video game, but a sophisticated system for the person who appreciates quality tools. It's worth more, because its unique features help you do more.

Colour Graphics

Apple's colour graphics permit applications ranging from business charting to architectural design. They make any presentation more effective.

Sound Synthesis

A built-in loudspeaker lets you explore audio applications from computer music to synthesized human speech.

Languages

Apple speaks BASIC, so you can use the programs already available in hundreds of publications. We offer a powerful scientific BASIC, with all the string and mathematical functions a programmer could want. We also offer assembly language and PASCAL for advanced users. More languages are under development.

Expansion Capacity

Apple II can handle complex applications, with up to 48k bytes of user memory space. And it can expand as your needs do, with a hefty power supply and eight connector slots for disks, printers, and other peripheral interfaces.

Apple is a system, not just a computer. It offers the peripherals and accessories the professional looks for. Whether you want printers, voice recognition, telecommunications, or high-density floppy disks. Apple can meet your needs.

The Apple system offers smart peripherals, so you can use them immediately without developing special control programs. They let you expand the capability of your system without adding boxes and power supplies.

Apple helps you learn, with the most complete documentation on the market. Whether you're an engineer designing computer interfaces or a beginner curious about programming, you'll find the information you need in our detailed manuals.

Floppy Discs.

Gives your system immediate access to large quantities of data. The subsystem consists of an intelligent interface card, a powerful Disk Operating System and one or two mini-floppy drives.

Features

- Storage capacity of 116K kilobytes/diskette. (140K with Pascal).
- Data transfer rate 156K Bits/second.
- Individual file write protection.
- Powered directly from Apple II.
- Full disk capability with systems as little as 16K bytes of RAM.



- Fast access time – 600 m sec (max) across 35 tracks.
- Powerful disk operating software.
- Load and store files by name.
- BASIC programs chaining.
- Random or sequential file access.

| Prices | Nett | Vat | Total |
|---------------------------|--------|--------|--------|
| Apple II 16k + free offer | 695.00 | 104.25 | 799.25 |
| Disk system | 349.00 | 52.35 | 401.35 |
| Second disk drive | 299.00 | 44.85 | 343.85 |

Latest Apple II plus model with floating point BASIC and Autostart ROM.

Colour output optional – requires Eurocolour card.

Parallel Printer Interface

The Parallel Printer Interface Cards are available to allow the use of parallel printers with your APPLE computer.

Features

- Built-in Firmware Allows Printing With Simple BASIC Commands
- Prints up to 255 Char/Line for format flexibility
- High Speed—up to 5000 Char/Sec (3700 LPM @ 80 Char/Line)
- Easy to Use with Most Popular Printers (Axiom, Centronics, SWTP, Selectric conversions).

Specifications

| PARAMETER | DESCRIPTION |
|---------------------------|---|
| Data and Control Signals: | 7-8 Parallel Data Bits, STROBE and ACKNOWLEDGE |
| Print Line Width: | 40-255 Char/Line. Automatic formatting of BASIC listings. |

| Price | Nett | Vat | Total |
|------------|--------|-------|--------|
| Parallel | 104.00 | 15.60 | 119.60 |
| Centronics | 130.00 | 19.50 | 149.50 |

Communications Interface Card

The Communications Interface Card is available separately to allow you to connect your APPLE to modems, CRT terminals, and other devices employing a serial RS-232C interface. The card's built-in intelligence lets you control these devices easily, in BASIC.

Features

- Firmware Control Programs
- No Software to Write
- Easily Controlled from BASIC using simple commands
- Communicates at 110 or 300 Baud, Half- or Full-Duplex
- RS-232C-compatible Serial Interface



Office:
 14 CASTLE STREET,
 LIVERPOOL L2 0TA.
 Registered in England No. 1375098

Retail Premises at:
 25 BRUNSWICK STREET,
 LIVERPOOL L2 0PJ.
 Tel:- 051-227 2535/6/7

Ab MA



Apple II

sets the standards.

| Specifications | PARAMETER | DESCRIPTION |
|----------------|-------------------|---|
| | Signal level: | EIA RS-232C |
| | Data Word Format: | 1 start bit, 1 or 2 stop bits, 7 or 8 data bits; odd, even or no parity |

| | Nett | Vat | Total |
|-------|--------|-------|--------|
| Price | 130.00 | 19.50 | 149.50 |

Serial Interface

The Serial Interface Card allows an APPLE computer to exchange data with computers, printers, and other devices in serial format (one bit at a time). It is intended for use (in place of the Communications Interface Card) in applications that:

- Use data rates other than 110 or 300 baud (10 or 30 char/sec)
- Involve serial printers that don't require "handshake".

Features

- Permits BASIC Control of High-Speed Printers and Plotters
- Quickly Transfers Large Blocks of Data by Telephone (through a modem), or Directly to Local Equipment
- Handles Half-Duplex Communication from 75-19.2K Baud
- Programs Easily with Switch-Selectable Preset Conditions for Speed, Line Length, Auto Line Feed and Carriage Return Delay

| Specifications | PARAMETER | DESCRIPTION |
|----------------|-----------------------------|---|
| | Signal Level: | EIA RS-232C or 20mA current loop |
| | Data Word Format: | 1 start bit, 1 or 2 stop bits, 5-8 data bits; odd, even, or no parity. Checksum is optional. |
| | Character Handling Options: | Lower-case characters optionally converted to upper-case or passed through unmodified and displayed in inverse video. |

| | Nett | Vat | Total |
|-------|--------|-------|--------|
| Price | 113.00 | 16.95 | 129.95 |

Eurocolour Card Produces PAL colour signals to drive colour video monitor or with a Black & White modulator drives a colour T.V.

| | Nett | Vat | Total |
|-------|-------|-------|-------|
| Price | 79.00 | 11.85 | 90.85 |

Language System

This package includes the Language Card, which allows APPLE users to take immediate advantage of the powerful PASCAL language as well as the Integer and Applesoft BASIC interpreters. The Language Card's 16K bytes of RAM memory electrically replace the ROM firmware built into each APPLE. Upon start-up, this RAM memory is automatically loaded from disk with the user's choice of languages, then electrically protected from change. The loading is controlled by the AUTO-START ROM, also contained on the card. The complete system also includes diskettes containing a language selection "Hello" program, PASCAL, Applesoft BASIC, and Integer BASIC. The reference manuals for all the above languages are also included.

| | Nett | Vat | Total |
|-------|--------|-------|--------|
| Price | 299.00 | 44.85 | 345.85 |

Apple Fortran

Apple FORTRAN is "ANSI Standard Subset FORTRAN 77." These latest computer industry standards provide significant additions and enhancements over previous 66 standards (FORTRAN IV). An example of this is the expanded "IF" statements that have been added to traditional FORTRAN statements.

Apple FORTRAN operates in the Apple Pascal Language system offering the same comprehensive software development environment provided to our Pascal programmers. The Editor, Linker, Filer and Assembler can all be used with the Apple FORTRAN compiler, which, like Pascal, produces 'P' code.

| | Nett | Vat | Total |
|-------|--------|-------|--------|
| Price | 120.00 | 18.00 | 138.00 |

Graphics Tablet

The Graphics Tablet is an image input device that allows the user to enter pictorial information directly (by sketching or tracing) from:

- maps and photographs
- logic diagrams and schematics
- histograms
- architectural drawings
- fine art

Tracing a shape on the tablet surface converts the image to digital values. This information is displayed on the video monitor and may be stored on disk for later processing by the Apple.

| | Nett | Vat | Total |
|-------|--------|-------|--------|
| Price | 462.00 | 69.30 | 531.30 |

Appletel

The Appletel package provides the means to bring the Apple II computer and the Prestel service together. The power of the Apple microcomputer makes the Appletel terminal much more than a simple Prestel receiver. You have the facility to store pages from Prestel in the computer and examine them later at leisure (saving telephone bills). You can automatically call up a sequence of pages of information you regularly need and/or store them. You can use the Appletel terminal to put your own information onto Prestel. Appletel has local editing facilities to help you do this. The fact that you have a full keyboard means that you can make good use of the Prestel facility for sending messages.

| | Nett | Vat | Total |
|-------|--------|-------|--------|
| Price | 595.00 | 89.25 | 684.25 |

Alf music synthesiser card

Three part harmony - plugs into domestic Hi-Fi up to three cards which gives nine parts harmony. Total controls of envelope shape.

| | Nett | Vat | Total |
|-------|--------|-------|--------|
| Price | 180.00 | 27.00 | 207.00 |

Clock/Calendar Card

This plug-in card provides a 388-day calendar and clock, with resolution to 1/1000 second. The clock is crystal controlled to yield .001% accuracy. A built-in rechargeable battery keeps the clock on time up to four days without system power, and external batteries may be used for longer periods. Optional interrupt capability simplifies control applications. Supplied with complete operating instructions and rechargeable battery.

| | Nett | Vat | Total |
|-------|--------|-------|--------|
| Price | 128.00 | 19.20 | 147.20 |



Office:
14 CASTLE STREET,
LIVERPOOL L2 0TA.
Registered in England No. 1375098

Retail Premises at:
25 BRUNSWICK STREET,
LIVERPOOL L2 0PJ.
Tel:- 051-227 2535/6/7



Apple II

sets the standards.

apple computer
Sales and Service



ROM Plus card

ROMPLUS + provides six sockets to accept individually addressable 2K ROM's or EPROM's. Keyboard Filter a 2K ROM program, comes installed on the ROMPLUS + board and adds many useful features to your Apple, including:

- Upper and lower case letters. The only system that offers keyboard input and standard shift key operation.
- Multiple user-defined character sets.
- Coloured or inverse-coloured letters.
- Keyboard macros – two key-stroke, automatic typing of multiple, user-defined words or phrases. Including BASIC and DOS commands.
- Mixed text and graphics.
- Improved cursor control.
- STOP LIST and END LIST.

| | Nett | Vat | Total |
|-------|--------|-------|--------|
| Price | 105.00 | 15.75 | 120.75 |

Hobby/ Prototyping Card

Create your own APPLE interface boards with this wire-wrap card. The 2 3/4" x 7", double-sided circuit board includes a hole pattern (on 100-mil centres) that accepts all conventional IC's and passive components. It plugs directly into any APPLE expansion connector, and fits entirely within the computer case. Supplied with complete bus documentation to aid the interface designer. (Order No. A2B0001).

| | Nett | Vat | Total |
|-------|-------|------|-------|
| Price | 15.00 | 2.25 | 17.25 |

Apple Pilot

PILOT is a high level, easy-to-use language which was designed for educators and courseware developers. Since 1968 many teachers and trainers have been using PILOT to create Computer Aided Instruction (CAI) programs. In fact, PILOT is available on more computers than any other CAI language. This means, a large number of potential customers and a large number of existing PILOT programs, most of which will run on the Apple PILOT system.

Apple PILOT has been designed to take full advantage of the Apple's unique features and at the same time offer a superior easy to use CAI system. Through the use of graphics and sound, the instructor can prepare lessons utilizing the full capabilities of the Apple II. Apple PILOT offers the courseware designer a total support system.

System Requirements

- Apple II or II PLUS with 48K memory
- One disk drive for "LESSON" mode or two disk drives for both "AUTHOR" and "LESSON" modes.
- DOS 3.3 or The Apple Language System.

Price on application

DOS 3.3

Apple's new DOS, DOS 3.3, contains two significant improvements for the Apple owner. It creates a compatible environment so that the Apple owner can easily and efficiently use his Applesoft, Integer, and Pascal programmes on one set of hardware. The second benefit for the user is that the disk space available is increased 23%. Under the old operating system, approximately 103,000 bytes were available to the user. With the new DOS, 126,976 bytes will be available for user programs.

Included with the new DOS is a utility to convert programs from the old disk format to the DOS 3.3 format, a fast single or double disk drive file copying program, a diskette to allow you to run unconverted software from the old disk format, and a flexible new file utility program. Also included in the package is a new DOS manual, and, of course, the necessary PROMs to change your Apple to the new disk format.

| | Nett | Vat | Total |
|-------|-------|------|-------|
| Price | 39.00 | 5.85 | 44.85 |

Other Prices

| | Nett | Vat | Total |
|--|---------|--------|---------|
| Applesoft Firmware Card – for integer Apples | 116.00 | 17.40 | 133.40 |
| Integer Card – For applesoft apples | 116.00 | 17.40 | 133.40 |
| IEEE 488 interface card | 212.00 | 31.80 | 243.80 |
| Vinyl carrying case | 16.00 | 2.40 | 18.40 |
| Speechlab – speech input | 127.00 | 19.05 | 146.05 |
| Supertalker – speech output | 136.00 | 20.40 | 156.40 |
| Sup 'R' Terminal – 80 column card | 253.00 | 37.95 | 290.95 |
| A.I.O., Serial and Parallel card | 120.00 | 18.00 | 138.00 |
| Appleset 16 channel 8 bit A-D | 166.00 | 24.90 | 190.90 |
| CCS 3 3/4 digit BCD A-D | 80.00 | 12.00 | 92.00 |
| Templeman dual 8" disk system – 1M byte | 1550.00 | 232.50 | 1782.50 |
| Numeric keypad | 125.00 | 18.75 | 143.75 |



Office:
14 CASTLE STREET,
LIVERPOOL L2 0TA.
Registered in England No. 1375098

Retail Premises at:
25 BRUNSWICK STREET,
LIVERPOOL L2 0PJ.
Tel:- 051-227 2535/6/7



Apple III



- Size:** 17.5 inches wide (44.45 cm)
18.2 inches deep (46.22 cm)
4.8 inches tall (12.2 cm)
Cast aluminium base with moulded plastic cover.
- Weight:** 26 pounds (11.8 kilos)
- Processor:** Apple designed processor utilizes 6502A as one of its major components. Other circuitry provides extended addressing capability, re-locatable stack and zero page, and memory mapping.
- Emulation Mode:** Provides hardware emulation of 48K byte Apple II or Apple II Plus. Allows most Apple II programs to run without modification.
- Clock Speed:** 1.8 MHz with video off, 1.4MHz average 1.0 MHz in emulation mode.
- Main Memory:** 96K (98,304) eight-bit bytes minimum 128K (131,072) bytes maximum Dynamic RAM memory
- Rom Memory:** 4K (4,096) bytes used for self-test diagnostics
- Power Supply:** High-Voltage switching type +5, -5, +12, -12 volts
- Mass Storage:** One 5.25 inch floppy disk drive built-in 140K (143,360) bytes per diskette
Up to 3 additional drives can be connected by daisy-chain cable (572K bytes on-line storage)
- Keyboard:** 74 keys (61 on main keyboard, 13 on numeric pad). Full 128 character ASCII encoded. All keys have automatic repeat.

Screen:

Three special keys: SHIFT, CONTROL, ALPHA LOCK. Two user-definable "Apple" keys. Four directional arrow keys with two-speed repeat. Four other special keys: TAB, ESCAPE, RETURN, ENTER.

Three upper/lower case text modes:-
80 column, 24 line black-and-white,
40 column, 24 line 16 colour foreground and background
40 column, 24 line black-and-white.

All text modes have a software-definable 128 character set (includes upper and lower case) with normal or inverse display

Three graphics modes:

280 x 192, 16 colours (with some limitations)
140 x 192, 16 colours
560 x 192, black-and-white plus Apple II Modes.

Video Output:

RCA phono connector for NTSC black-and-white composite video. DB-15 type connector for:

NTSC black-and-white composite video
4 TTL outputs for generating RGB colour.
Composite sync signal. NTSC colour composite video. +5, -5, +12, -12 volt power supplies

Colour signals appear as 16-level grey scale on black-and-white video outputs.

Audio Output:

Built-in 2 inch speaker. Miniature phone-tip jack on back of Apple. Driven by six-bit digital/analog converter or fixed-frequency "beep" generator

Serial I/O:

RS-232C compatible, DB-25 female connector. Software selectable baud rate and duplex mode.

Joysticks:

Two DB-9 connectors for two joysticks with pushbuttons.

Printer:

One DB-9 connector (shared with second joystick) for Apple Silentype printer.

Clock:

Can be set and read from programs. Powered by long-life replaceable watch batteries. Keeps track of month, date, day of week, and exact time to 1/1,000th of a second.

Expansion:

Four 50-pin expansion slots inside the cabinet

SOS:

Sophisticated Operating System handles all system I/O SOS can be configured to handle standard or custom I/O devices and peripherals by adding or deleting "device drivers"

All Languages and Application programs access data through the SOS file system.

Languages:

Apple Business BASIC, PASCAL, FORTRAN

Phone for a price



Office:
14 CASTLE STREET,
LIVERPOOL L2 0TA.
Registered in England No. 1375098

Retail Premises at:
25 BRUNSWICK STREET,
LIVERPOOL L2 0PJ.
Tel:- 051-227 2535/6/7





Apple Software

Payroll I
Weekly/Monthly. Up to 200 employees. 375.00 56.25 431.25
Weekly/Tax, National Insurance and Pension. Up to 20 departments.

Payroll II
Weekly/Monthly. Up to 99 employees. 200.00 30.00 230.00
Less detailed reports as in above. Excellent value.

LEDGERS

Sales

500 accounts, 1600 transactions, Credit limit check. 100 Analysis codes, aged debtors analysis.
Program 295.00 44.25 339.25
Manual 3.00 3.00

Purchase

500 accounts, 1600 transactions
Turnover aggregated for each customer.
Program 295.00 44.25 339.25
Manual 3.00 3.00

General

Trial Balance/Accumulated profit/Loss on demand. 1000 named accounts, 1700 postings.
Program 295.00 44.25 339.25
Manual 3.00 3.00

Optional Applications Manual

Uses for incomplete records, group consolidation branch accounts, etc. 10.00 10.00

Inventory Control

Probably the most powerful package on the market. 1250 items/disk, 600 suppliers. Automatic re-order routine. Fully documented, easy to use, well proven in the field.
Program 225.00 33.75 258.75
Manual 3.00 3.00

Other Applications:

Point of sale stock control
Licensed trade stock control.

Visicalc

Visicalc and Apple do to the calculator what word processing has done to the typewriter. Plan budgets, rate of returns, financial statements, tax effects, sales forecasting, "What if?" Uses are endless and visicalc is limitless.
Visicalc 95.00 14.25 109.25

Mailing List

Company name/address/contact/telephone no. 375 records/disk. Add, amend, delete. Print all/selected records. Print self adhesive labels. 27.00 4.05 31.05

Apple Desktop/Plan

A business planning and analysis system designed to aid development and analysis of business plans such as budgets, sales forecasts, cash flow planning, profit and loss predictions and many other similar types of analysis 64.00 9.60 73.60

Applewriter

Most probably the best word processing system available on a microcomputer for the price. Features include: high speed versatile cursor control, moving blocks of text, delete by character, word and paragraph, left, right, centre justifications, upper and lower case, very easy to use, well documented. 42.00 6.30 48.30

Credit Control

An ideal aid for the business who needs tight control on their debtors. Holds up to 850 accounts. Informs you if any order exceeds the credit limit. Easy to use. 75.00 11.25 86.25

Sales Control
Gives breakdown of sales per client over the last 3 years and each month this year. Shows number of unconverted enquiries, reports, on printer between user development parameters on area product turnover to date, turnover this month. Many other valuable reports. 150.00 22.50 172.50

FOR FURTHER DETAILS PLEASE RING

Programming Aids and Tutorials

| | Nett | Vat | Total |
|---|-------|------|-------|
| Applepie (Integer) | 30.00 | 4.50 | 34.50 |
| Assembler Editor (Machine Code) | 45.00 | 6.75 | 51.75 |
| Data Base (Integer) | 23.50 | 3.53 | 27.03 |
| Disk magic (Integer) | 16.00 | 2.40 | 18.40 |
| Hi Resolution Character Generator (Applesoft) | 16.50 | 2.48 | 18.98 |
| Appleforth (Integer) | 39.95 | 5.99 | 45.94 |
| Large Character (Integer) | 16.00 | 2.40 | 18.40 |
| Lisa (Integer) | 28.50 | 4.28 | 32.78 |
| Master Catalogue (Applesoft) | 14.00 | 2.10 | 16.10 |
| Shape Builder (Applesoft) | 17.00 | 2.55 | 19.55 |
| Step by Step (Applesoft) | 37.50 | 5.63 | 43.13 |
| Talking Disk (Integer) | 14.95 | 2.24 | 17.19 |
| Three D Animation (Integer) | 12.95 | 1.94 | 14.89 |
| Tiny Pascal (Integer) | 40.00 | 6.00 | 46.00 |

Business Programs

| | | | |
|----------------------------|-------|------|-------|
| Active Filter (Applesoft) | 15.00 | 2.25 | 17.25 |
| Audio Engineer (Applesoft) | 15.00 | 2.25 | 17.25 |
| Index File (Integer) | 16.00 | 2.40 | 18.40 |
| Statistics (Applesoft) | 19.95 | 2.99 | 22.94 |

Games and Simulations

| | | | |
|--|-------|------|-------|
| Games Pack 1 (Integer) | 12.00 | 1.80 | 13.80 |
| Games Pack 2 (Integer) | 12.00 | 1.80 | 13.80 |
| Games Pack 3 (Integer) | 12.00 | 1.80 | 13.80 |
| Games Pack 4 (Integer) | 12.00 | 1.80 | 13.80 |
| Games Pack 5 (Integer) | 12.00 | 1.80 | 13.80 |
| Games Pack 6 (Integer) | 12.00 | 1.80 | 13.80 |
| Games Pack 7 (Applesoft/Integer) | 12.00 | 1.80 | 13.80 |
| Alien Encounters (Applesoft) | 8.00 | 1.20 | 9.20 |
| Alien Invasion (Machine Code) | 8.00 | 1.20 | 9.20 |
| Apple Invaders (Integer) | 12.00 | 1.80 | 13.80 |
| Battlefield (Applesoft) | 8.00 | 1.20 | 9.20 |
| Biorhythm (Applesoft) | 10.00 | 1.50 | 11.50 |
| Breakthrough (Machine Code) | 8.50 | 1.28 | 9.78 |
| Bulls and Bears (Integer) | 12.00 | 1.80 | 13.80 |
| Datestones of Ryn (Applesoft) | 12.95 | 1.94 | 14.89 |
| Death Race (Integer/Machine Code) | 10.95 | 1.64 | 12.59 |
| Earth Quest (Integer) | 11.50 | 1.73 | 13.23 |
| Galactic Battle (Integer) | 8.00 | 1.20 | 9.20 |
| Guided Missiles (Machine Code/Integer) | 10.95 | 1.64 | 12.59 |
| Invasion Orion (Applesoft) | 18.00 | 2.70 | 20.70 |
| Laser Blast (Machine Code/Integer) | 12.00 | 1.80 | 13.80 |
| Lunarlander (Machine Code/Integer) | 9.25 | 1.35 | 10.64 |
| Phasor Zap (Integer) | 10.00 | 1.50 | 11.50 |
| Saucer War (Applesoft) | 9.95 | 1.49 | 11.44 |
| Space Traders (Applesoft) | 12.95 | 1.94 | 14.89 |
| Space Wars (Machine Code/Integer) | 12.95 | 1.94 | 14.89 |
| Speedway (Integer) | 10.00 | 1.50 | 11.50 |
| Star Voyager (Integer) | 15.95 | 2.39 | 18.34 |
| Strato Laser (Applesoft) | 10.95 | 1.64 | 12.59 |
| Stunt Cycle (Machine Code) | 10.50 | 1.58 | 12.08 |
| Super Dungeons (Integer) | 12.95 | 1.94 | 14.89 |
| Super Starwars (Machine Code/Integer) | 11.25 | 1.69 | 12.94 |
| Starfleet Orion (Integer) | 18.00 | 2.70 | 20.70 |
| Temples of Apshai (Applesoft) | 22.95 | 3.44 | 26.39 |
| U.F.O. (Machine Code/Integer) | 8.50 | 1.28 | 9.78 |
| War Lords (Integer) | 12.00 | 1.80 | 13.80 |

Educational, Mathematical and Scientific Programs

| | | | |
|----------------------------|-------|------|-------|
| Function Pilot (Applesoft) | 18.50 | 2.78 | 21.28 |
| Planets (Applesoft) | 15.00 | 2.25 | 17.25 |
| Sirus (Applesoft) | 15.00 | 2.25 | 17.25 |



Office:
14 CASTLE STREET,
LIVERPOOL L2 0TA.
Registered in England No. 1375098

Retail Premises at:
25 BRUNSWICK STREET,
LIVERPOOL L2 0PJ.
Tel:- 051-227 2535/6/7



Video Genie

Value and TRS 80 compatibility



20 free Microdigital quality Cassettes with each Genie

The Video Genie is a complete computer system, requiring only connection to a domestic 625 line TV set to be fully operational; or if required a video monitor can be connected to provide the best quality display.

The system case contains the Central Processor Unit (CPU), 16,000 bytes RAM memory, the cassette system, a 12,000 byte operating system and BASIC interpreter in ROM, and a full size keyboard, in a stylish case, at a price that makes the Video Genie better value than some "kit" computers.

Keyboard

The Video Genie has a 51 key typewriter style keyboard, which features a 10 key rollover. This makes it very easy for experienced and inexperienced typists alike to enter programs and data into the machine.

Applications

The Video Genie System has many uses in all spheres of life, the easy to use BASIC language means that programs are easily written for specific applications, and pre-recorded program tapes are available in great variety.

The system has great scope in the home, sophisticated games programs can introduce the computer age to all the family, who can then progress to writing their own programs in BASIC or even machine code. Software is continuously being developed to aid home budgeting and education.

In a school or college the machine can be used with a large screen TV to allow a whole class to be taught at once.

The powerful Extended BASIC interpreter makes the solution of complex scientific problems simple, and the graphics allow pictorial displays of results.

Extended BASIC

- Single, double and integer - precision numeric variables, as well as string variables.
- multi-character variable, with the first two characters significant.
- program lines, logical lines and string variables up to 255 characters long.
- includes all scientific functions.
- numeric accuracy up to 16 significant digits, with intrinsic functions at 6-digit accuracy.

- formatted, printing, program editing (with extensive editing subcommands), error trapping, named files, program tracing, automatic line numbering, multi-statements per line, and keyboard rollover allowed.
- multi-dimension arrays, and complete string manipulation.
- direct memory inspection, and input/output commands provided.
- direct graphic commands.
- allows access to machine language subroutine.
- many other advanced features, all included in the detailed programming manuals.

Cassette Unit

The Video Genie has an integral cassette system which can save information on standard tape cassettes. An interface is also provided to connect an external audio cassette unit for greater storage flexibility.

Accessories

The Video Genie is supplied with the following accessories:-
BASIC demonstration tape.
Video lead
Second cassette manual

Manuals

Users manual
BASIC manual
Beginners programming manual

These manuals provide an excellent course of instruction for the beginners to computing. They take the user gently through the subject, explaining the concepts of computing with the Video Genie.

Software

The Video Genie utilises the same renowned extended BASIC interpreter as the TRS-80. Most software for the TRS-80 will run on the Video Genie so an enormous range of software is available.

| | Nett | Vat | Total |
|-------|--------|-------|--------|
| Price | 330.00 | 49.50 | 379.50 |

Price does not include T.V./monitor



Office:
14 CASTLE STREET,
LIVERPOOL L2 0TA.
Registered in England No. 1375098

Retail Premises at:
25 BRUNSWICK STREET,
LIVERPOOL L2 0PJ.
Tel:- 051-227 2535/6/7



Printers



Tally/Mannesmann M80/77/MC

A printer for the professional user. This new printer from T/M offers fast, dependable and cost effective hard copy data processing for the business man. Its high speed, 200 c.p.s., bi-directional print mechanism will ensure that your printer is not tied up all day. We are able to offer this printer at a price that includes a 1K character buffer and 132 column print option included in the price. Serial or parallel compatible.

We feel that this printer will fulfill the requirements of the most demanding user, whether it be Payroll, Ledgers or Stock-control, the M80 will handle the application with minimum fuss for the User.

| Price | Nett | Vat | Total |
|--------------------------------------|---------|--------|---------|
| Tally/Mannesmann M80/77/MC | 1000.00 | 150.00 | 1150.00 |
| Includes 1K Buffer, 132 Print Option | | | |



Oki Microline 80

Quality and reliability at a price that makes it available for business, educational and home-user applications. The features and specifications of this small lightweight printer are those of models costing many times more.

80 characters per second

80 and 132 columns program selectable

Full 96 character set with graphics printing facility

Long life 9 x 7 print head matrix parallel and serial compatible.

Friction and Pin Feed as standard.

| Price | Nett | Vat | Total |
|---------------------|--------|-------|--------|
| Microline 80 | 499.00 | 74.85 | 573.85 |
| Tractor Feed Option | 35.00 | 5.25 | 40.25 |

Microhush 200

This, the latest in the line of thermal printers, offers all the high performance features of the Microhush 100, plus an 80 column printing capacity and the ability to reproduce the whole screen of a 'Apple' high resolution image, utilising a 60 dots per inch definition.

| Price | Nett | Vat | Total |
|---------------|--------|-------|--------|
| Microhush 200 | 349.00 | 49.35 | 398.35 |

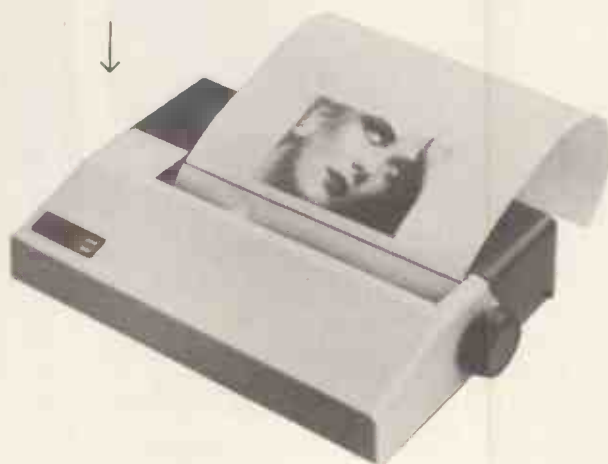

Microhush 100

A fast reliable thermal printer offering the user a high definition 96 character set created by a 5 x 7 print head. Its 40 characters per second, bidirectional look-ahead printing and extremely quiet operation, ensures a high performance at low cost.

Interfacable to most microprocessor systems including Apple, Sorcerer and RS 232.

| Price | Nett | Vat | Total |
|---|--------|-------|--------|
| Microhush 100 including 'Apple' interface | 299.00 | 44.85 | 343.85 |

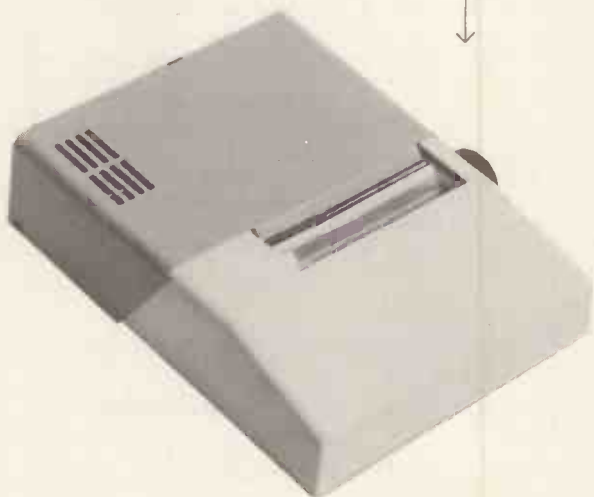

LASKYS
LONDON



Office:
14 CASTLE STREET,
LIVERPOOL L2 0TA.
Registered in England No. 1375098

Retail Premises at:
25 BRUNSWICK STREET,
LIVERPOOL L2 0PJ.
Tel:- 051-227 2535/6/7



Atom



| Prices | Nett | Vat | Total |
|-----------------------|--------|-------|--------|
| Atom Kit 8K + 2K | 120.00 | 18.00 | 138.00 |
| Atom Ass 8K + 2K | 150.00 | 22.50 | 172.50 |
| Atom Kit 12K + 12k | 220.00 | 33.00 | 253.00 |
| Atom Ass 12k + 12K | 250.00 | 37.50 | 287.50 |
| 1K RAM sets | 9.50 | 1.43 | 10.93 |
| 4K Floating Point ROM | 20.00 | 3.00 | 23.00 |
| Printer driver | 11.50 | 1.73 | 13.23 |
| Mains Power Supply | 8.00 | 1.20 | 9.20 |

The Basic Atom

Elegantly designed and injection moulded in heavy duty polystyrene, the Atom measures only 15" long x 9 1/2" deep and 2 1/2" high fitting snugly inside a normal briefcase.

And yet it still contains a full sized keyboard laid out in a conventional typewriter way. The full travel, light pressure keys give a positive reliable action, better for both the amateur and experienced typist.

To use the Atom immediately you just connect the power supply and a cable into the aerial socket of a television set. Any UHF colour or monochrome set will do - the Atom doesn't harm them at all.

The Atom has an initial 2K of RAM and 8K of ROM but of course this can be boosted enormously. The standard computer has Basic and Assembler (machine code) graphics and sound output, with direct cassette and TV interface. (See further for list of specifications.) Basic is the language used by Atom and is indeed the language used by most personal computers. The Basic used has all the normal functions you would expect plus many powerful extensions making it easier for you to operate and write your own programs. In personal computer terminology 'powerful' means the machine works harder cutting down the amount of information that you would otherwise have to type in.

How your Acorn Atom grows Internally

Both screen and program memory can be expanded in 1K blocks up to 12K total, and the fixed memory can be added to in two blocks of 4K. One is the 4K floating point arithmetic package. The printer interface requires the addition on board of a 6522 and buffers.

The PAL encoder module when fitted allows full colour output to a domestic colour TV although a simple modification allows direct connection to a colour monitor without a PAL encoder.

Externally

The most exciting addition however is the communication

module which fits inside the case and allows high speed communication to other systems which can be anything from an Acorn System One to an IBM 370 and what's more any number of other Atoms. Designed for classroom use where, for example, twenty Atoms may be linked both to each other and to the teacher's system. The teacher can take control of any keyboard and display for instruction purposes, and can link any pupil to a printer or disc storage facility. In the home or laboratory however, this module may be used to control substations such as System 1 with any of the Acorn interface modules.

nb. Existing owners of Acorn systems may use the tape interface as a simple communication line to and from the Atom.

Technical Description

Memory: From 2K to 12K RAM on board (in steps of 1K) up to 40K including external memory. From 8K to 16K ROM (two 4K additions).
Processor: 6502 with 1 Mc/s clock.
Video Display Generator: 6847 generates video signals for 8 different modes including: high resolution graphics (256 x 192), Red, green, and blue graphics up to resolution of 128 x 192, and mixed ASCII characters and semigraphics.
PIA: 8255 provides keyboard scan, cassette I/O port (one used for printer output) plus a wide range of serial I/O functions and dual timers.
Cassette Interface: CUTS 300 baud, involves minimum hardware (zero crossing detector input and output from timer) to allow user to redefine tape routine to virtually any speed or standard.
Loudspeaker: Driven from 8255 via buffer allowing software tone generation of any frequency.
B/W Video Output: To monitor.
UHF Modulator Output: Channel 36 domestic T.V.
Bus Output: Fully buffered address and data bus plus internal connections for one Acorn Eurocard.
Power Requirement: Minimum system: 8 volts @ 800mA (from Atom power unit feeding internal regulator). Maximum system: 5V @ 1.8A from external regulator supply.

Hardware

Technical Description

Atom basic: 32-bit arithmetic ($\pm 2,000,000,000$), High speed execution, 43 standard and extended BASIC commands, Variable length strings (up to 256 characters), String manipulation functions, 27 32-bit integer variables, 27 additional arrays, Random number function, PUT and GET bytes, words and strings to and from files, WAIT command for timing, DO-UNTIL construction, Commands may be abbreviated for economy, Multiple statements per line, Logical operators (AND, OR, EX-OR), LINK to machine code routines, Numbers can be input and printed in hexadecimal, Symbolic labels for fast branches and subroutine calls, Powerful indirection operators (?), Graphics facilities to draw points and lines, 16 PLOT commands, MOVE and DRAW.
Assembler: Mnemonic Assembler for machine code programming, Formatted listing, Assembler and BASIC may be combined. Standard 6502 mnemonics, Provides symbols, automatic resolution of forward references, Macro-facilities, Breakpoints may be inserted for debugging.
VDU: 32 characters x 16 lines, Inverted characters, Automatic scrolling, Paged/Non paged modes, All control codes can be generated, Screen editing, Operating System, CUTS cassette routines with checksum, Filenames up to 12 character, LOAD and SAVE BASIC and assembler programs or text files, Search (catalogue) routine, Software hook to optional disc drive and communication loop modules, Printer drive routines.
Optional Maths Software: Floating point maths functions to 9 digit accuracy including arithmetic, trigonometric and hyperbolic functions.
Optional Communication Software: Allows high speed bi-directional interface to other Atoms or peripherals, Allows transfer of control or data to other modules in loop.
Optional Utility ROM: Such as the ONLIBASIC extension for real time control of laboratory experiments.

Software

Cassettes/Disks

Disks

High Performance Mini Floppy disks

- Made by Kybe corporation
- Anti static envelopes
- soft sectored
- single sided, single density
- free library cases (with 10 or more disks)
- labels and write protect tabs supplied

| Prices | Nett | Vat | Total |
|-------------------|--------|-------|--------|
| one disk | 3.00 | 0.45 | 3.45 |
| ten disks | 22.00 | 3.30 | 25.30 |
| fifty disks | 100.00 | 15.00 | 115.00 |
| one hundred disks | 180.00 | 27.00 | 207.00 |

Cassettes

Quality Microcomputer Cassettes.

- C15 Agfa Tape
- Special Labels
- Cellophane wrapped
- Precision transport mechanism
- Leaderless
- Insert Cards
- Screw fixing case
- Proven performance

| Prices | Nett | Vat | Total |
|-----------------------|-------|------|-------|
| one cassette | 0.80 | 0.12 | 0.92 |
| box of ten cassettes | 5.20 | 0.78 | 5.98 |
| fifty cassettes | 25.00 | 3.75 | 28.75 |
| one hundred cassettes | 45.00 | 6.75 | 51.75 |



Office:
14 CASTLE STREET,
LIVERPOOL L2 0TA.

Registered in England No. 1375098

Retail Premises at:
25 BRUNSWICK STREET,
LIVERPOOL L2 0PJ.

Tel:- 051-227 2535/6/7



BOOKS

SYBEX BOOKS**Introduction to Personal and Business Computing**

by R. Zaks

A comprehensive yet simple introduction to the micro computer world for the potential user whether it be for home or business use.

Microprocessors - From Chips to Systems by R. Zaks

The basic text on micros for everyone with a technical or scientific background. This book teaches all the fundamentals of microprocessors step by step.

Microprocessor - Interfacing Techniques by R. Zaks

This comprehensive book introduces the basic interfacing concepts and techniques, then presents the implementation details from hardware to software.

Programming the 6502 by Rodnay Zaks

This book is an educational text designed to teach programming, using the 6502. It does not require any prior programming knowledge, yet can be used to advantage by anyone wishing to familiarize himself with the 6502. An invaluable book for owners of the PET, Apple, Kim etc.

6502 Applications Book

This book presents practical applications techniques for the 6502 ranging from a complete home alarm system to an industrial control loop for temperature control. Also includes analog to digital conversion and simple peripherals from paper-tape reader to micro printer.

Programming the Z-80

Another in the highly successful Sybex Series by Rodnay Zaks. This book combines the function of a teaching text, that Sybex do so well, with an extensive reference section. The book is much more than an introduction to the Assembly Language syntax of the Z-80.

SCELBI BOOKS**Understanding Micros** by N. Wadsworth

If you are at all curious about small computers you must own this no-nonsense text which explains all the fundamental concepts behind the operation of virtually all microcomputers.

Calculating with BASIC

Here's a variety of programs in BASIC to help apply the language to practical problems. The book covers problems in finance, statistics, engineering, mathematics and electronics. Good descriptions and examples are provided with each program listing.

PIMS Personal Information Management System

This book is really a ready to use data base system in Microsoft BASIC with full instructions. An excellent starting point for your home applications.

OSBORNE BOOKS**Z-80 Assembly Language Programming**

These books are assembly language primers in the "classical sense" - they treat assembly language as a means of programming a microcomputer system and are full of simple programming examples.

6502 Assembly Language Programming by Leventhal

Another fine manual in the Osborne Assembly Language series to join the best selling 8080, 6800 and Z-80 books.

PET and the IEEE 488 Bus (GPIB) by Fisher & Jenson

A book for instrument designers, scientists, programmers and hobbyists - which shows how you can have a low-cost versatile system that may be interfaced to any of hundreds of electronic instruments.

Introduction to Microcomputers by A. Osborne - Volume 0: The Beginners Book

If you know nothing about computers this is the book to begin with. It explains what computers are and describes their components.

Introduction to Microcomputers by A. Osborne - Volume 1: Basic Concepts

This book describes application techniques common to all microprocessors yet specific to none. All the basic hardware and software concepts are explained simply.

Introduction to Microcomputers - Osborne (September 1978 Edition)**Volume 2 - Some Real Microprocessors**

This 9" x 7" loose leaf format book covers every major microprocessor on the market. 4 bit to 16 bit in detail and analyses more than 20 CPUs. Includes new sections on the most recent entries into the microprocessor market. Describes support devices for use with only one microprocessor.

Volume 3 - Some Real Support Devices - loose leaf

A companion volume to volume 2. This describes the micro support devices which can be used with more than one microprocessor - including system buses.

Some Common BASIC Programs

Includes 76 short programs covering financial, mathematical, statistical and general interest subjects, all of which have been tested.

Z-80 Programming for Logic Design

These books describe the implementation of sequential and combinational logic using assembly language. They describe the meeting ground of the programmer and the logic designer and are written for readers in both fields.

ADDISON - WESLEY BOOKS**Artificial Intelligence** by Winston

Artificial intelligence is concerned with extending the application of computers and gaining an understanding of the principles that make intelligence possible. This book designed for use in a course on artificial intelligence should prove invaluable to the newcomer to the topic as well as to the experienced as a reference text. Part one covers an introduction to

4.90

the key ideas in the subject such as representation, symbolic constraint exploitation, search and control. Part two covers the LISP programming language and its use. The book is profusely illustrated.

Problem Solving and Structured Programming in BASIC

by Koffman and Friedman

The book reflects the view that good problem solving and programming habits should be introduced at an early stage. Three separate phases of the solution are used:-

- 1) Specification of the algorithm using flow diagrams.
- 2) Analysis of the problem.
- 3) Implementation of the problem solution.

The Little Book of BASIC Style by Nevison

Structure style and correctness and maintainability are the attributes of good programming - they are getting much attention as well they should. When one considers what we invest in programs their manageability and efficiency become very important. In this book these concepts are explained along with 19 rules and many examples in BASIC to help improve your programming style.

A Guide to BASIC Programming by Spencer

A first course in BASIC for Scientists, Business people and Engineers. The book illustrates the application of the language with numerous examples which will be useful later in your BASIC programming career.

Introducing System Design by Squire

This book assumes some knowledge of computers and from this builds a review of the techniques used in system design through data base, security of the system and top down design. An important book for the student of business use of computers.

Software Tools by Kemigan and Plauger

This text is designed to emphasise Structured Programming and Top Down Design. It deals with filters, formatting, files, sorting, text patterns, editing and macro-processing.

BASIC and the Personal Computer by Dwyer & Critchfield

The authors provide a detailed presentation of BASIC and extended BASIC. Included are many applications possible on any microcomputer. Readers are encouraged to think about personal computing in its widest sense, write programs and research new applications. A selection of projects appears at the end of each chapter. The book may be used as a self-study text or a course book.

Problem Solving and Structured Programming in FORTRAN

by Friedman & Koffman

This book is designed for a short first course in computer programming. This book introduces the techniques of structured programming at a very early stage. The authors emphasize three distinct phases of problem solving: 1) the analysis of problem 2) the specification of an algorithm and 3) the language implementation of the algorithm.

A Course in APL with Application by Grey

This introductory text may be used by either the experienced computer user familiar with at least one general purpose language, or by the beginner with no previous programming experience. The presentation aims to show that APL is a refinement and enhancement of mathematics. Emphasis is placed on the use of APL as an ideal language for formulating and developing algorithms.

Programming in PASCAL by Grogono

This introductory language manual is an excellent start to one of the fastest growing programming languages today. The book is arranged as a tutorial containing both examples and exercises to increase reader proficiency with the language. Besides a chapter on procedures and files there are sections on dynamic data structures such as trees and linked lists. These concepts are put to use in an example of bus service simulation.

Programming a Microcomputer (6502) by Faster

This book will teach you how to program a microcomputer in machine language. Although designed specifically for the 6502 microprocessor used in the Kim 1, PET and the Apple. The basic principles involved apply to all computers.

The Computer - An Everyday Machine by Squire

This text puts the data processing computer in perspective, introduces it as a tool that can be used and understood by anyone. The approach is to take a simple problem, analyse it and then solve it using a hypothetical language and a computer consisting of the simplest possible units. The book is an excellent introduction to the computer as used by large scale businesses. The author is a systems engineer with IBM Canada and provides her own interesting perspective. The book is widely used by business management students as their first introduction to computers.

The Art of Computer Programming Volume 1 -**Fundamental Algorithms** by Knuth

This is the first book in this world wide best selling series and thought by many as the best books of their type available. Volume 1 begins with a thorough review of the mathematical techniques used, although it does not assume mathematics above high school level in the reader. It goes on to review assembly level programming and ends with a 200 page review of information structures. The book contains numerous exercises.

8.90

5.70

8.80

9.65

8.15

9.70

9.90

9.70

6.90

7.20

8.40

9.90

6.95

9.90

7.90

7.90

8.90

7.90

7.90

7.45

8.10

8.20

9.90

5.90

6.25

14.90

10.90

7.90

6.25

13.75



Office:
14 CASTLE STREET,
LIVERPOOL L2 0TA.
Registered in England No. 1375098

Retail Premises at:
25 BRUNSWICK STREET,
LIVERPOOL L2 0PJ.
Tel:- 051-227 2535/6/7



BOOKS

- The Art of Computer Programming Volume 2 – Semi-Numerical Algorithms** by Knuth 16.40
This book covers random numbers, random sequences, statistical tests, floating point arithmetic, multiple precision arithmetic, polynomials etc. This book offers a comprehensive interface between existing knowledge of computer programming and numerical analysis including a substantial amount of complexity and number theory statistics. It assumes 'A' level mathematics capability.
- The Art of Computer Programming Volume 3 – Searching and Sorting** by Knuth 20.40
This text is by far the most comprehensive survey of these computer techniques ever published. The material is presented such that the general principles are applicable to a wide range of problems. Some knowledge of computer techniques and elementary calculus is assumed.
- CREATIVE COMPUTING BOOKS**
- BASIC Computer Games** by David Ahl 5.45
The first collection of games all in BASIC. Contains both a complete listing and a sample run of each game along with a descriptive write up.
- More BASIC Computer Games** by David Ahl 5.45
This is the sequel to the best selling "BASIC Computer Games". 84 fascinating and entertaining games for solo or group play. All games are complete with a program listing in BASIC, a sample run and a description. Standard Microsoft BASIC is used throughout and the programs are simple to use with almost all microcomputers.
- WELLER BOOKS**
- Practical Microcomputer Programming with the Z-80** by Weller 19.50
18 chapters of solid accurate programming information. Debugging techniques, interrupt modes, array and table handling, number base conversation, floating point arithmetic, programmed input/output stockpointer usage. The book includes an editor assembler listing for Z-80 and 8080. If you return the coupon at the back of the book you receive either paper tape or TRS 80 cassette of the object code for the assembler.
- HOWARD SAMS BOOKS**
- Microcomputer Primer** by M. Waite and M. Pardee 6.30
Written for the beginner in the computer field. All the basic concepts and characteristics of microcomputers are explored and explained.
- Getting Acquainted with Micros** by L. Frenzel 6.90
Learn about microcomputers in an effective low cost manner. The essential information contained in this book has been compiled especially for Engineers, Technicians and Scientists but is equally invaluable to the layman.
- Computer and Programming Guide for Engineers** by D. Spencer 9.10
Written specifically for the Engineer or Scientist, this book explains what a computer is, how it works and how it can be used to the best advantage. Details FORTRAN and BASIC programming.
- TTL Cookbook** by D. Lancaster 7.10
Discover what transistor-transistor logic is, how it works and how to use it. Discusses practical digital applications and teaches you how to build TTL systems that entertain test and train.
- CMOS Cookbook** by D. Lancaster 7.45
Your complete guide to the understanding and use of Complementary Metal-Oxide-Silicon integrated circuits. Gives usage rules, power supply design examples, applications, bread boarding and coverage of logic.
- TV Typewriter Cookbook** by D. Lancaster 7.20
A comprehensive guide to low cost television display of alpha-numeric and graphics data for microprocessor systems word processing, TV titling and video games.
- Cheap Video Cookbook** by D. Lancaster 4.90
A complete guide to super low cost alphanumeric and graphic microprocessor based video displays – this book picks up where the TV Typewriter Cookbook ended.
- How to Program Micros** by W. Barden Jnr. 6.90
Explains assembly language programming of microcomputers based on the 8080, 6800 and 6502 microprocessors. Basic concepts, number systems and operations, computer operation and codes are examined.
- Z-80 Microcomputer Handbook** by W. Barden Jnr. 6.90
This book provides essential information on Z-80 technology and is organised into three sections: Hardware, software and microcomputers built around the Z-80.
- Microcomputers for Business Applications** by W. Barden Jnr. 7.10
This book will prove invaluable to a potential buyer of a business microcomputer system – helping him to select the best system for his particular needs. The micros discussed range from spin-offs of hobbyist computers to complete "turnkey" systems with customised software.
- The S-100 and Other Micro Buses** by Poe and Goodwin 5.10
This book is about buses and after acquainting the reader with bus basics moves on to detail the eleven most widely used bus systems.
- BASIC Primer** by Waite and Pardee 6.90
This book is exactly what it says it is – on top of this it also includes 7 appendices to help you optimise your code for speed or memory use. Finally at the back is a reference card which you will keep in your pocket during the rest of your BASIC programming career.
- Z-80 Microprocessor Programming and Interfacing Volume 1** by Nichols and Rony 7.70
This book is the first of a two volume series on the Z-80. It covers programming at the assembly and machine language level for the Z-80. Book 2 will cover interfacing. The books are laboratory oriented texts. The strong emphasis is on learning through experiment. This book requires no background in computers.
- Z-80 Programming and Interfacing Book 2** by Nichols and Rony 8.45
Address interfacing digital circuits with the Z-80 CPU, PIA and CTC chip and progresses on from Book 1 (Interfacing) assuming the reader is familiar with the topics covered in Book 1.
- Industrial Process Control System** by Patrick and Fardo 8.90
Process control procedures, system concepts, components, industrial applications and study questions in a logical text book.
- TRS-80 Interfacing** by J. A. Titus 6.90
Requiring a good understanding of Level II BASIC, this book describes the signals available in the TRS-80 computer and their applications to the control of external devices. Experiments in the construction and use of some typical interfaces are included.
- The Howard W. Sams Crash Course in Microcomputers** by L. E. Frenzel 10.60
Written in a teach yourself format with study questions, this book provides a solid background in microcomputers quickly and effectively. All aspects from fundamentals and operating systems to programming and peripherals.
- Computer Graphics Primer** by M. Waite 8.90
Instruction in the methods of producing drawings, plans, maps and schematics on a CRT display. In 3 sections, 'Perspectives', 'Basic Concepts' and 'Graphics Programming'.
- 6502 Software Design** by L. Scanlon 7.90
Fundamentals of 6502 operation are explained and then extended to give a comprehensive coverage of 6502 use.
- Z-80 Microcomputer Design Projects** by W. Barden Jnr. 9.10
A solid introduction to the Z-80 microcomputer and the EZ-80 chip. Simple construction of the EZ-80 microcomputer and several applications.
- BUTTERWORTH BOOKS**
- Basic BASIC** by J. Coan 6.45
One of the most widely sold text books on BASIC. The book uses over 100 example problems to illustrate the essential techniques of the language.
- Advanced BASIC** by J. Coan 5.95
Develops the readers expertise with BASIC through strings and files to graphing and more important mathematical functions.
- FORTRAN Fundamentals – A Short Course** by Jack Steingraber 3.40
A fast and efficient guide to FORTRAN – providing an abbreviated means of learning the language. Sample problems and their solutions are included.
- Programming for Microprocessors** by Andrew Calin (hardback) 3.40
This book has been written for those converting from other disciplines to the use of microprocessors. It is designed to allow fast progress to a useful working understanding of the application of microprocessors and includes sections on number representation.
- Sargon: A Computer Chess Program** by Dan and Kathe Spracklen 9.45
Here is the computer chess program that won first place in the first chess tournament at the 1978 West Coast Computer Faire. It is written in Z-80 assembly language using the TDL macro assembler. It comes complete with block diagram and sample printouts.
- The Systems Analyst** by J. Attwood (Hardback) 7.45
From the initial decisions whether or not to use a computer for a specific problem, to the actual installation of the completed system, the book covers the strategies, skills and techniques needed. Written without complex maths it is a step by step guide for people developing systems for the business world.
- How to build a Computer-Controlled Robot** by Tod Loofbourrow 5.90
Every step of the construction of "Mike" is explained with photographs and diagrams to direct you through the construction. The complete control programs for a robot are clearly written out. You may use the directions exactly as they are set forth in the book or as a basis for developing your own design. "Mike" can be built within the budget of the average hobbyist and the only technical requirement for building him is the ability to read and understand a circuit diagram.
- How to Profit from your Personal Computer – Professional, Business and Home Applications** by T. G. Lewis 5.45
Written for business people and computer hobbyists contemplating business applications, it shows how to put your computer to work for you. It describes common business applications such as accounting, handling payroll, managing inventory, sorting mailing lists and many others.
- FORTRAN with Style** 4.70
A little book to allow you to write professional and well laid out FORTRAN programs.
- BASIC with Style** 3.90
This type of book is sorely needed by us all as we develop our understanding of BASIC, so that we may adopt some of the disciplines needed to make robust readable programs.
- Game Playing with BASIC** by D. Spencer 5.45
A non technical book which includes an appreciation of the rules, structure and output for each example discussed.
- Sixty Challenging Problems with BASIC Solution** 5.90
Contains 60 games, puzzles, mathematical, science and business problems for reinforcing computer programming skills in the BASIC language.



Office:
14 CASTLE STREET,
LIVERPOOL L2 0TA.
Registered in England No. 1375098

Retail Premises at:
25 BRUNSWICK STREET,
LIVERPOOL L2 0PJ.
Tel:- 051-227 2535/6/7



BOOKS

| | | | |
|--|-------|---|-------|
| Problems for Computer Solution 821 problems are arranged by topic ranging from mathematical disciplines to science and business. | 5.10 | Build your own working robot | 4.60 |
| DILITHIUM BOOKS | | Digital Interfacing with an Analog world | 6.45 |
| Instant BASIC by G. Brown | 7.15 | How to Build your own Self-Prog. Robot | 5.30 |
| Here for the microcomputer enthusiast is finally a book to teach you BASIC which slowly introduces new ideas in a non-mathematical context. | | How to Design and Bld. Your own working comp. System | 5.70 |
| Interspersed with amusing graphics this book is fun to use. | | How to Build your own working robot PET | 4.90 |
| Beginning BASIC by P. Chirlian | 7.45 | How to Build your own 16-bit Micro | 3.20 |
| An introduction to BASIC for beginners written in response to the author's children's needs for a really basic BASIC. | | Illustrated Dictionary of Micro-Terminology | 5.70 |
| Starship Simulation by R. Garrett | 5.40 | Introduction to VLSI Systems | 10.90 |
| Simulation is the name of the game and it can be done on a small computer. | | Microprocessor Cookbook | 4.60 |
| 32 BASIC Programs for the PET Computer | 9.70 | Modern Digital Communications | 5.90 |
| by Rugg & Feldman | | Modern Guide to Digital Logic | 5.70 |
| 32 BASIC programs for the PET computer is precisely that. 32 fully documented programs that are ready-to-run on your Commodore PET 2001 computer. You also have the option of making a number of changes, as suggested, to these programs if you wish. | | Programs in BASIC for Elec. Eng. Tech. and Exp | 4.30 |
| Introduction to TRS-80 Graphics by D. Inman | 6.40 | 57 Practical Progs. & Games in BASIC | 5.70 |
| For some time now, graphic displays on microcomputers have been out of the reach of hobbyists because of their complexity and high cost. In this book the author will show you how, with a minimal knowledge of the BASIC computer language and your TRS-80 computer, you can create graphic displays that only a few years ago were the exclusive turf of the big computer owners. The book begins with the basics and works from line drawings through geometrics and right on up to moving figure animation and more advanced operations. A great handbook on computer graphics for microcomputer owners at all levels of experience. | | Programming Microprocessors | 4.90 |
| How to make money with your Microcomputer | 5.70 | 24 Tested & Ready-to-run Games & Prog. | 4.70 |
| by Townsend & Miller | | Artificial Intelligence | 5.30 |
| The microcomputer system can be used as a "lever" to multiply your income and it is a tool of great power. It can do many jobs the individual cannot do at all also process routine jobs in much less time that you could do them by hand. The possibilities only limited by your own creativity. This book will give a start with dozens on money making ideas. | | Complete Handbook of Robotics | 5.70 |
| MICROSOFT (TM) BASIC by Knecht | 6.70 | 6502 Cookbook | 7.70 |
| A tell it all book for TRS 80 users. It presents an introduction and tutorial on programming in MICROSOFT BASIC. The concepts presented are illustrated with examples that actually run. By starting with the simplest and most commonly used commands and then progressing onto the more complex instructions. The author illustrates how the more powerful versions of the BASIC language can save time and effort. Only an understanding of Computer fundamentals is required for the users of this book and the language is applicable to most small systems including the Apple and the PET. | | Z-80 Instruction set | 3.10 |
| Peanut Butter and Jelly Guide to Computers by Jerry Willis | 6.15 | 6502 Games | 8.90 |
| This book is a welcome relief from the jungle of jargon and technical terms which seem to thrive like twitch grass in the garden of personal computing. It is a book rich with details you need to know and written in a style which is easy to understand. It is an important book for the beginner to be read first. It also has a wealth of information for the expert. | | Pascal for PET | 8.95 |
| COMPUSOFT BOOKS | | Computer in Maths | 10.90 |
| Learning Level II BASIC by David Lien | 11.00 | TRS 80 Disk & Other Mysteries | 11.90 |
| This is the second excellent book by CompuSoft Publishing in California. No TRS-80 owner can afford to miss this one. | | Micros & the 3R's | 5.90 |
| The BASIC Handbook by David Lien | 11.00 | Some Common BASIC Programs/Pet (Osborne) | 8.90 |
| This is a machine independent reference text for the BASIC on most personal computers. It also shows the syntax for the new ANSI standard BASIC. It is the only book of its kind in print at present. | | PET Personal Computer Guide (Osbourne) | 10.45 |
| MISCELLANEOUS | | Practical BASIC Programs (Osbourne) | 9.90 |
| Best of Micro - Volume 1 | 5.45 | Introduction to T-Bug | 6.20 |
| Micro is the best known and most widely read of the specialist journals dealing with the 6502 microprocessor as used in the PET, Apple, Aim, OSI, CompuLink Minimax, etc. "Best of Micro" is a bound version of the first six issues. | | The BASIC Workshop | 4.90 |
| Best of Micro - Volume 2 | 6.45 | Introduction to Structured FORTRAN | 9.20 |
| This is the bound version of the second six issues of Micro up to mid 1979. | | Microcomputer Systems Principles Featuring 6502/KIM | 9.20 |
| The Mighty Micro by Chris Evans | 5.75 | Microprocessor Systems Engineering | 14.90 |
| This is the book written out of the well-known ITV series giving a more positive view perhaps than Adam Osborne's book. | | Fundamental Principles of Micro-Architecture | 14.90 |
| SIGMA BOOKS | | | |
| Computer Programs that Work by Lee, Beech and Lee | 3.95 | | |
| This book contains twenty four programs in BASIC in the areas of biology, mathematics, chemistry and physics and includes simulations of real-life situations and popular games. | | | |
| Z-80 Instant Programs (Nascom) | 7.50 | | |
| These machine code routines can be entered in to a Z-80 system etc. and are applicable to even the smallest machines. The routines average 1000 instructions. | | | |
| NEW TITLES | | | |
| Programming and Interfacing the 6502 | 8.90 | | |
| Pascal with Style | 4.70 | | |
| Robots on your doostep | 5.70 | | |
| A-Z of computer games | 5.30 | | |
| BASIC Cookbook | 3.90 | | |
| Basic Digital Electronics | 3.90 | | |



Office:
14 CASTLE STREET,
LIVERPOOL L2 0TA.
Registered in England No. 1375098

Retail Premises at:
25 BRUNSWICK STREET,
LIVERPOOL L2 0PJ.
Tel:- 051-227 2535/6/7



LIVERPOOL SOFTWARE GAZETTE

The Bi monthly Magazine for the computer user.
Only 75p a copy. Subscription £9.00 for 12 issues.



Issue 1
Sargon meets the Nascom
Pets Corner
Programming Practices and Technics
M5 system – and interpreter for the Nascom One
I'm Pilot fly me
Apple Pips
Acorn Mastermind
Pascal bytes the Apple
Random Rumours



Issue 2.
Dungeons & Dragons revisited
Numerical Accuracy of Microcomputers
Cesil – an introduction
Acorn and the Kim
Z-80 Processor Profile
Revas & Zeap
Application software for Microcomputers
Pets Corner
Nybbles
Chess for the Acorn
Etcetero
Surround
Apple Pips
A hex on you
Programming Practices and Technics
Trekking by JTK
Nascom Notes
Byting more off your Disk
Stop Press

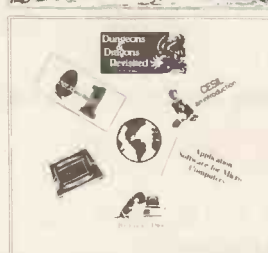

Issue 3
Pets Corner
Nascom Notes
Apple Pips
Aim 65 Assembler
Graphic shape scaling
Pilot takes off
Letter from America
Pascal – An introduction
Programming Practices and Techniques
Algol 68C on the Z80
Microcomputer and Bio-chemistry
Sharp machine language
Super sort
Software and Acorn
Numerical Accuracy
Etcetera

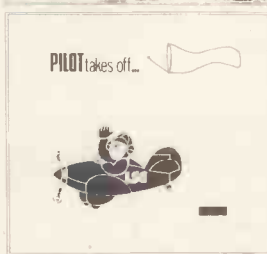

Issue 4
Star Gate
Sharp point
Letters to the Editor
Pets Corner
Apple Pips
Nascom Notes
Jet set
6800 Processor Profile
A forth Introduction
Pascal An Introduction
A Beginners Introduction to Pascal
A Useful Pascal Program
A Marvel called the MC6809
A Number Processor on the Acorn
Architectural Software on the Cheap
Commercial Micro Software Fundamentals
Graphics Shape Translation
Future Soft
Programming Practices
Etcetera

Please send me twelve issues of the Liverpool Software Gazette starting with the first/second/third/fourth/fifth/sixth* issue. Cheques and PO's should be made payable to Liverpool Software Gazette and sent to us at 14 Castle Street, Liverpool.

Name

Address

Postcode

*delete as applicable.





Microdigital Mail Order Form

Date: _____

Access: 5224

Barclaycard 4929

Expiry date: _____

Name _____

Address: _____

Post Code _____

Tel (day) _____

| Goods required | Price |
|----------------|-------|
| 1 | |
| 2 | |
| 3 | |
| 4 | |
| 5 | |
| 6 | |
| 7 | |
| 8 | |
| Total | |

Terms and Conditions

In addition to cash we accept, Access, Barclaycard, Stereo Club and cheques covered by a bankers card.

VAT in this brochure has been calculated at the rate of 15% current at the time of writing. Please allow for any changes.

Postage and carriage is offered free of charge within the United Kingdom. All products are covered by our 1 year warranty against failure due to faulty materials or workmanship.

Official orders over £10 are welcome, with normal 14 days credit extended to bona-fide commercial Organisations.

All prices, specifications and terms are subject to change without notice at the discretion of the management.

The entire contents of this brochure are copyright Microdigital Limited 1980.

Laskys Stereoclub – the easy way to buy from Microdigital.

Laskys Stereoclub means you can now afford the computer you've always wanted. Once you've been issued with your Stereoclub card you get instant credit right up to your limit – 24 times your monthly payment. For just £5 a month, for instance, you would get credit up to £120. And you can add to your Stereoclub account all your accessories as and when you need them. Ask Microdigital for your application form.

Mail Orders to:
 MICRODIGITAL LIMITED
 FREEPOST (No stamp required)
 Liverpool L2 2AB

24 Hour – 7 Day
 ANSAPHONE SERVICE
 on 051-236 0707

Microdigital Free Competition

Place the following points in their order of importance. (Nos. 1 – 12) and then say in no more than 12 words "Why buy from Microdigital?"

| | |
|---|--|
| Wide Range:- Microdigital sell machines selected for quality and value for money from the smallest computers to big commercial systems. | |
| Competitive Prices:- The advantages of our buying power and experience are passed on to our customers. | |
| All plugs & Leads free:- We sell a computer as a ready to run complete system with all connectors necessary. | |
| 12 months guarantee:- Most microcomputers sold in this country come with a 90 day guarantee. We give a full parts and labour guarantee for a full year. | |
| Access/Barclaycard/Stereo Club:- Alternative ways to finance your computer. Laskys stereo club provides flexible easy credit. | |
| Free delivery:- Anywhere within Mainland U.K. There is no extra hidden charge when you buy from Microdigital. | |
| Specialisation:- All our resources are put into Microcomputers, nothing else. We know what we are best at. | |
| 14 days credit:- On official orders from bona-fide commercial and government organisations (subject to credit clearance). Makes buying easier. | |
| Fast, Friendly Service:- Our expert staff look after our customers first and our large stocks ensure good availability of everything we sell. | |
| Freepost:- It costs nothing for you to write to us, an extra service to make life easier. | |
| A Lasky's Company:- We have the resources of Europe's largest Hi-Fi chain behind us. The customer can be confident of continued support. | |
| All equipment tested before despatch:- We want to be sure that everything we sell works when it should. | |

Name _____

Address _____

In 12 words: Why buy from Microdigital?

Rules

- (1) Only one entry per person.
- (2) The competition will be judged on November 14.
- (3) All entries should be received by November 7th.
- (4) The decision of the judges is final.
- (5) In the event of a tie the winner will be decided by the best slogan.
- (6) Employees of the Ladbroke group and this publication are not eligible.
- (7) Entries to Microdigital Ltd., 25 Brunswick St., Liverpool L2 0PJ.



Registered Office:
 CHANCEL HOUSE,
 NEASDEN LANE,
 LONDON NW10.
 Registered in England No. 137098

Prices correct at
 time of going to
 press (Oct. 1980)

SUPERBRAIN™



System Specification

- * Dual 4MHz Z-80 C.P.U.s
- * Dual double-density mini-floppies (320K bytes)
- * Dynamically focused 12 inch CRT
- * 25 lines by 80 characters
8 x 8 in 8 x 12 field

- * Full ASCII keyboard
- * S-100 Bus via direct connection
- * Dual synchronous/asynchronous RS 232 ports
- * CP/M^(tm) operating system
- * Single desk top unit

SOFTWARE SUPPORT

- Wide range of standard software (FORTRAN, COBOL, BASIC, APL, Pascal). Sales Order processing, invoicing, sales ledger, purchase ledger, nominal ledger, payroll, Word Star (word processing).
- 90 day warranty
- One year maintenance **£155.00**
- Full client support

£1495

COMPLETE (+ VAT)

*** OUR PRICE IS THE R.R.P.**

**K.G.B. MICROS LTD.
88 HIGH STREET
SLOUGH, BERKSHIRE
TEL. SLOUGH 38581**

SUPERBRAIN™ is the registered trademark of Intertec Data Systems.

● **Circle No. 185**

BYTE SHOP

COMPUTERLAND

your specialist Computerstore.

Well-proven systems for the serious user. Our computer stores are staffed by business experts, backed by first class maintenance support. Call in for advice and a demonstration of our range of systems.

Cromemco System Three →

The Cromemco buyer is choosing well-proven design, reliability and expandability. Start with a single terminal and grow into a multi-user system as your requirements expand. Excellent Cromemco software includes COBOL, FORTRAN and RPG-II. Ask for a demonstration of the Cromemco hard-disk and talk over with us how your application can be programmed.



← *North Star Horizon*
The reliable and long-established commercial favourite. Ask about our BYTE SHOP-developed packages – Invoicing, Sales and Purchase Ledger, Incomplete Records, Cash-Flow Analysis, Stock Control, etc. And use your Horizon to type perfect letters – it is an excellent word-processor.

Nottingham
92a Upper Parliament Street
Nottingham NG1 6LF
Tel. 0602 40576 Telex. 377389

Manchester
11 Gateway House
Piccadilly Station Approach
Manchester
Tel. 061-236 4737 Telex. 666168

Birmingham
94-96 Hurst Street
Birmingham B5 4TD
Tel. 021-622 7149 Telex. 336186

Glasgow
Magnet House
Waterloo Street
Glasgow Tel. 041-221 7409
Telex. 779263

BYTE SHOP
COMPUTERLAND
– your specialist Computerstore.

London
48 Tottenham Court Road
London W185 4TD
Tel. 01-636 0647

• Circle No. 186

(continued from previous page)

Much time is wasted with LIST, and Q = USR(0) commands. Since LIST always returns Pet to the direct mode regardless of call, it is very difficult to obtain a program listing under program control.

The listing overcomes this limitation. It works by adding lines to list the program. As long as the line numbers in the program to be tested are not greater than 59,999, it will work.

```

100 REM PROG LIST PR40 :
    M. VALENTINE
110 PRINT"STO LIST A PROGRAMME
    ON A PRINTER THAT
120 PRINT"QUES Q = USR(3) TO PRINT
    LAST LINE
140 PRINT "QI WILL LIST LINES 60000-
    60180 ON THE PET
145 PRINT"SCREEN"
150 PRINT"QLOAD THE PROGRAMME
    TO BE LISTED
160 PRINT"QKEEPING THE LISTING.
    HIT RETURN TEN TIMES
170 PRINT"QTHEN TYPE RUN 60000
    FOLLOWED BY RETURN
180 PRINT"QHIT A KEY TO CONTINUE"
190 Q = USR(0):REM FULL SCREEN
    PRINTOUT
100 GETQS:IFQS = "" THEN200
210 PRINT"S":LIST60000-60180
    60000 LO = 1025: HI = 1026
    60020 LI = PEEK(LO + 2) + (256*(PEEK
    (HI + 2))):
IFLI>59999THENEND
    60035 PRINT"SLIST":LI:FORI = 1TO5:
    POKE624 + I,PEEK(32772 + I):NEXT
    60040 POKE158, 11:POKE623, 76:POKE
    624, 201
    60050 POKE630, 13:POKE631, 67:POKE
    632, 207:POKE633, 13
    60090 STOP:LO = PEEK(LO) + (256*
    (PEEK(HI))):HI = LO + 1
    60110 L = 40: IFPEEK(33128) = 18THENL
    = 80
    60120 LIS = "" :FORI = 1TOL:Q = PEEK
    (32768 + (40*6) + I):IFQ<31. 5THENQ = Q + 64
    60160 LIS = LIS + CHR$(Q):NEXTI:PRINT
    LEFT$(LIS,39):Q = USR(3): IFL = 40THEN
    60020
    60180 PRINTMID$(LIS,40,39):Q = USR(3):
    GOTO60020
READY.
SYS0
TO LIST A PROGRAMME ON A PRINTER
THAT USES Q = USR(3) TO PRINT LAST
LINE I WILL LIST LINES 60000-60180 ON
THE PET SCREEN
LOAD THE PROGRAMME TO BE LISTED
KEEPING THE LISTING. HIT RETURN
TEN TIMES
THEN TYPE RUN 60000 FOLLOWED BY
RETURN
HIT A KEY TO CONTINUE
    
```

RAM-space sabotage

ABOUT A year ago, a demonstration I was giving went horribly wrong writes Julian Allason. Mysterious out-of-memory errors kept occurring. A quick ?FRE(0) revealed that less than 200 bytes of RAM remained although the program was a mere 3K running on a supposedly 8K machine.

I say supposedly because what the saboteur had done was to portion off most of the free RAM space. Here is how.

On old-ROM Pets, the address of the last byte of RAM is stored at decimal location 135. Peeking that location on an 8K Pet would normally return a value of 32 because $32 \times 256 = 8,192 = 8K$. By Poking an eight into location 32, Basic

was fooled into thinking that it lived inside a 2K Pet.

The cure for such tomfoolery was POKE135,32. On a 32K Pet the value stored in that location should be $128; 128 \times 256 = 32768 = 32K$ — remember?

Yet ?PEEK(135) returns the value 96 on a new-ROM 32K Pet. Obviously, the location has been changed. How to find it? Since we know that the location we are looking for should contain a 128, the following short program will help:

```

100 A = 0
110 A = A + 1
120 IF PEEK(A) = 128 THEN PRINT
    "LOCATION "A" CONTAINS 128"
130 GOTO 110
    
```

This routine reveals the following suspect locations: 49, 53, 136, 224, 226, 227, 228, 229 and 230. So let us test them as follows:

```

100 DATA 49,53,136,224,225,226,227,228,
229,230, -1
110 PRINT "FREE RAM = "; FRE(0)
120 READ A
130 IF A = -1 THEN PRINT
    "FINISHED";END
140 PRINT "NOW POKING LOCATION"
:A
150 POKE A,8
160 GOTO 110
    
```

The results show that Poking location 53 with an eight immediately reduces the number of bytes apparently free. As a final check, we can execute a Poke 53,128 to check that the full amount of memory available has been restored to us.

Since Basic stores variables and arrays from the top of RAM downwards, this technique of portioning-off a section of memory could prove useful. Storage of long machine-code programs is one possible application.

Normal and reverse video

I HAVE written a machine-code subroutine for the Pet which will alternate the screen display between normal and reverse video says G J Kelly of Bradford. However, blank spaces are not altered.

I have found the subroutine very useful in a program for highlighting the display at, say, an important part in a game. The two versions can be loaded into the second cassette buffer either by the machine code monitor in the new-ROM Pet or by the loader program.

Program A

```

033A 18 CLC
033B A000 LDY# 00
033D 8401 STY 01
033F A280 LDS # 128
0341 8602 LOOP1 STX 02
0343 B101 LOOP2 LDA (01),Y
0345 C920 CMP # 32
0347 F004 BEQ NEXT
0349 4980 EOR # 128
034B 9101 STA (01),Y
034D C8 NEXT INY
034E D0F3 BNE LOOP2
0350 E8 INX
0351 E084 CPX # 132
0353 D0EC BNE LOOP1
0355 60 RTS
    
```

Basic Loader for Program A

```

10 DATA 24,160,0,132,0,162,128,134,16,177
20 DATA 15,201,32,240,4,73,128,145,15,200
    
```

```

30 DATA 208,243,232,224,132,208,236,96
40 FOR J = 826 TO 853
50 READ A: POKE J,A
60 NEXT
    
```

The program can be called from Basic with SYS826 — the rate of change could be controlled with a for/next loop.

```

10 SYS826:FOR J = 1 TO 500: NEXT:
GOTO 10
    
```

Program B

```

033A 18 CLC
033B A500 LDA 00
033D 6900 ADC # 00
033F 8500 STA 00
0341 B003 BCS PASS
0343 4C2EE6 JMP 58926
0346 18 PASS CLC
0347 A000 LDY# 00
0349 8401 STY 01
034B A280 LDS # 128
034D 8602 LOOP1 STX 02
034F B101 LOOP2 LDA (01),Y
0351 C920 CMP # 32
0353 F004 BEQ NEXT
0355 4980 EOR # 128
0357 9101 STA (01),Y
0359 C8 NEXT INY
035A D0F3 BNE LOOP2
035C E8 INX
035D E084 CPX # 132
035F D0EC BNE LOOP1
0361 A900 LDA # 00
0363 8500 STA 00
0365 4C2EE6 JMP 58926
    
```

Basic Loader for Program B

```

10 DATA 24, 165,0,105,133,0,176,3,76,46,230
20 DATA 24,160,0,132,1,162,128,134,2,177,1
30 DATA 201,32,240,4,73,128,145,1,200,208
40 DATA 243,232,224,132,208,236,169,0,133
50 DATA 0,76,46,230
60 FOR J = 826 TO 871
70 READ A: POKE J,A
80 NEXT
    
```

This subroutine can be called independently of any other program the computer is executing. At the start of your program, alter the IRQ interrupt vectors — located at 144,145 — to include the subroutine located in the second cassette port.

The rate of change can be varied by Poking a number into location 830; zero will inhibit the change. It is important that the interrupt vectors are altered together, i.e., as one line of the program otherwise the program will crash.

After using the subroutine, the interrupt vectors should be returned to their original values, again on the same program line.

```

10 POKE 144,58: POKE 145,3: REM This will
run the subroutine everytime there is an IRQ
interrupt
20 REM Your program
100 POKE 830,5: REM Set rate of normal to
reverse video
110 REM Your program
1000 POKE 830,0: REM This turns off
subroutine
1100 POKE 144,46: POKE 145,230: REM
This returns IRQ to normal
1200 END
    
```

Both subroutines use part of zero-page memory occupied by the user jump function for the variable address necessary to point to the screen memory. Therefore, if your main program uses the user function the variable address pointers should be re-located as required.

Program B uses the IRQ interrupt so care must be taken if part of your program uses interrupt. Also any small error in program B will usually result in the computer crashing.

FINANCIAL ACCOUNTING SYSTEMS

For the Commodore PET Computer

Comprising:

- 1: Sales Ledger
- 2: Purchase Ledger
- 3: Nominal Ledger
- 4: Open Item Sales Ledger
- 5: Open Item Purchase Ledger
- 6: Open Item Nominal Ledger
- 7: Integrated Sales, Purchase & Nominal Ledgers
- 8: Integrated Open Item Sales, Purchase & Nominal Ledgers
- 9: Budgets Within Nominal Ledgers (3, 6, 7 and 8)
- 10: Invoicing & Analysis Integrated with Sales Ledger (1, 4, 7 & 8)
- 11: Stock Recording Integrated with Invoicing and Analysis

**Note Requires 32k Computer, 3040 Disk Drive & Printer

**** Sensibly Priced Software for the Commodore PET ****

SOFTWARE LICENCE FEES

Systems 1. to 6. £90.00 + vat each

Add-ons 7. to 9. £50.00 + vat each

Add-on 10. £100.00 + vat

Add-on 11. £150.00 + vat

Pre-Printed Stationery Available

Send for System Specifications and Sample Printout



THISTLE COMPUTERS

39 ALBERT STREET

KIRKWALL

KW15 1HQ

(0856) 3140

And at The Square, Beauly, Inverness.

** We also supply the hardware for the above systems **

• Circle No. 187

* TX-80B 80 COLUMN DOT MATRIX PRINTER

EPSON

£349

+ VAT



FEATURES

- * Reliability
- * Low cost
- * 70 lines/minute
- * Compact size
- * 96 Chars + Pet Graphics
- * Condensed line, enhanced print
- * Self-test
- * 5 x 7 dot. matrix, 6 x 7 for graphics
- Centronics parallel interface standard

OPTIONS:

- * PET, APPLE, TRS80, VIDEO GENIE, RS232.
- Interface board and cable £40 each + VAT
- * NASCOM Interface cable £12.

* MEMORY BARGAINS

| | | | |
|-----------------------|-------|-------|-------|
| 4116-200ns, 16K x 1 | 1+ | 10+ | 100+ |
| DRAM Ceramic | 3.75 | 3.35 | 2.80 |
| 2708-450ns, 1K x 8 | 4.75 | 4.00 | 3.45 |
| EPROM | | | |
| 2716-450ns, 2K x 8 | | | |
| INTEL Type single +5V | 10.45 | 9.65 | 8.45 |
| 2732-450ns, 4K x 8 | | | |
| INTEL Type single +5V | 28.85 | 23.45 | 18.99 |
| 2114-1K x 4 | | | |
| SRAM | 3.95 | 3.60 | 3.00 |
| | | | + VAT |

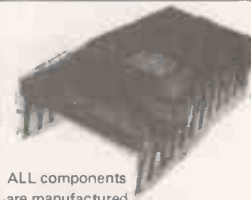

ALL components are manufactured

by leading companies and guaranteed full specification.



FREE 2708 EPROM



The versatile microprocessor development tool, connects directly to TV or monitor, can copy burn, verify 2708, 2716 EPROMS has serial (RS232) or parallel link for any small computer — only £120 built and tested, kit £100, power supply £20 equivalent development systems cost £500+ + VAT



NOW £319 + VAT

VIDEO GENIE SYSTEMS EG3003 —

Based on TRS-80, utilises Z80, 12K Level 11 Basic 16K RAM, INTEGRAL CASSETTE Deck, UHF O/P, All TRS-80 features. Interfaces to EPSON printer.

12" MONITOR
Ideal for Personal and Business Computers £65 + VAT

VIDEO GENIE EXPANSION BOX
£219 + VAT

- * Low Cost EPROM Eraser £34 + VAT
- * High Speed Eraser typically 4-7 mins 2708 £97 + VAT

Q-Tek Systems Ltd

2 Daltry Close, Old Town, Stevenage, Herts
Tel (0438) 65385

24 HOUR DESPATCH
(Stock Permitting)

• Circle No. 188

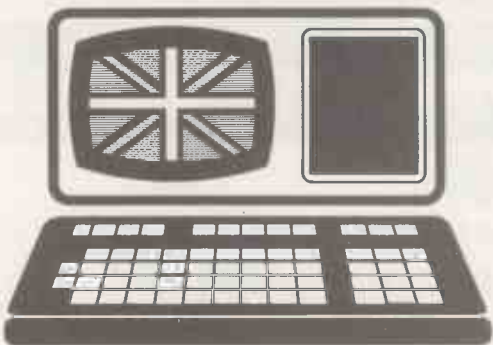

THE GREAT BRITISH MICRO

Hytec combine American Technology, British Ingenuity and a user friendly interface to give

High Performance Large Disk Capacity Business & Communications Software

Hytec further provide comprehensive pre and post sales support for both hardware and software including full training, and user familiarisation.

The Hytec H-series starts at around £3,500. For further information please write to or phone Hytec Microsystems Ltd., 1-3, St. Georges Place, Oxford OX1 2BL.

Telephone (0865) 726644/5

HYTEC



• Circle No. 189

APPLE® II DISK DRIVES

DUAL DISK UNIT

£498

DISK CONTROLLER CARD

£ 49

- * Two Disks in one Cabinet
- * Has its own Power Supply Unit
- * Connects to standard Apple Disk Controller Card
- * Runs all Apple Software including Pascal
- * Japanese quality and reliability



APPLE DEALERS: Write or phone direct to Cumana and specifications plus dealer discounts will be mailed to you.

TRS-80® DISK DRIVES

DUAL DISK UNIT

2 x 40 Track Drives
2 x 77 Track Drives

£440
£645

SINGLE DISK UNIT

1 x 40 Track Drive
1 x 77 Track Drive

£236
£345

TRS 80 DISK CABLES

2 Drive Cable
4 Drive Cable

£20
£32.50

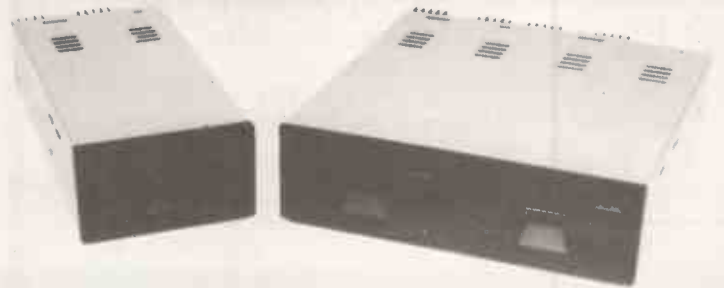

TRS-80 DEALERS: Write or phone direct to Cumana and specifications plus dealer discounts will be mailed to you.

MAIL ORDER MINI FLOPPY DISK DRIVES

| | Qty | Price Each |
|--|-------|-------------|
| TEAC FD-50A 40 TRACK 5¼ inch | 1-5 | £155 |
| DOUBLE/SINGLE DENSITY DRIVES | 6-12 | £145 |
| PRICE INCLUDES WARRANTY, SPECIFICATION MANUAL AND MAINTENANCE MANUAL | 13-25 | £135 |



Call your nearest dealer for a demonstration:

RADIO SHACK LTD.,
188 Broadhurst Gardens,
LONDON NW6
Tel: 01-624-7174

**LONDON COMPUTER
CENTRE,** 43 Grafton Way,
LONDON W1.
Tel: 01-388-5721

MICRO CONTROL LTD.,
224 Edgware Road,
LONDON W2
Tel: 01-402 8842

**TRANSAM COMPONENTS
LTD.,** 59-61 Theobalds Road,
LONDON WC1
Tel: 01-405-5240

N.I.C., 61 Broad Lane,
Tottenham, LONDON N15
Tel: 01-808-0377

EWL COMPUTERS LTD.,
8 Royal Crescent, GLASGOW
Tel: 041-332-7642

**KATANNA MANAGEMENT
SERVICES,** 22 Roughtons,
Galleywood, CHELMSFORD,
Tel: 0245-76127

ENSIGN, 13-19 Milford Street,
SWINDON, Wilts.
Tel: 0793-42615

SEVET TRADING,
14 St. Pauls Street,
BRISTOL 2.
Tel: 0272-697757

**HEWART MICRO-
ELECTRONICS,**
95 Blakelow Road,
MACCLESFIELD.
Tel: 0625-22030

**PORTABLE MICRO-
SYSTEMS,** 18 Market Place,
BRACKLEY, Northants.
Tel: 0280-702017

**CAMBRIDGE COMPUTER
STORE,** 1 Emmanuel Street,
CAMBRIDGE
Tel: 0223-65334

HARDEN MICROSYSTEMS,
28-30 Back Lord Street,
BLACKPDOL
Tel: 0253-27590

I.C. ELECTRONICS
Flagstones, Stede Quarter,
BIDDENDEN, Kent
Tel: 0580-291816

PARWEST LTD.,
58 Market Place,
CHIPPENHAM
Tel: 0249-2131

COMPUTERAMA LTD.,
5 Cleveland Place East,
London Road, BATH
Tel: 0225-333232

COMPSHOP LTD.,
14 Station Road,
NEW BARNET, Herts.
Tel: 01-441 2922

CUMANA LTD 35 Walnut Tree Close, Guildford, Surrey, GU1 4UN.
Telephone: (0483) 503121. Telex: 859680 (Input G).

Please add VAT to all prices.
Delivery at cost will be advised
at time of order.

• Circle No. 190

We have had so many requests for advice about software for the little ZX-80 that we have decided to start a club page devoted to the machine. If you have a contribution to make, write to *Practical Computing* marking your letter ZX-80 Line-up. We pay £5 for contributions published.

Card tricks

THINK of A Number is a simple game programmed in the integer Basic for the ZX-80. The game originated in a cracker at Christmas and when one of the cards was lost, it was programmed into the first handy computer.

The game consisted of a group of cards with numbers on them. A member of the audience was asked to think of a number between, say, one and 63. The participant was then shown each card in turn and asked if the number was on it.

When the last card had been shown and assuming everything had been done above board, the card sharp would tell the audience what the participant's choice was.

The program follows this procedure and should end with the same correct answer. There are plenty of comments so no further explanation will be given otherwise it would give the game away. The player should answer the question is the number on this page? with either yes or no.

The program will run on most Basics with only minor changes. For Basic with string input, lines 520, 530, 730 and 740 should be altered.

```

5 REM DIMENSION ARRAY
10 DIM R(20)
15 REM SET UP ANSWER VARIABLES
20 LET Y=1
30 LET N=0
35 REM CLEAR SCREEN
40 CLS
45 REM NUMBER OF BITS
50 LET P=5
55 REM CALCULATE MAXIMUM NUMBER
60 LET Z=1
100 FOR I=1 TO P
110 LET Z=Z*2
120 NEXT I
130 LET Z=Z-1
195 REM ASK PLAYER TO SELECT A NUMBER
200 PRINT "THINK OF A NUMBER BETWEEN 1 AND "Z
210 PRINT "READY?"
220 INPUT B
225 REM INITIALIZE ANSWER VARIABLES
230 LET S=0
240 LET T=1
295 REM MAIN LOOP - LOOP FOR EACH BIT
300 FOR A=1 TO P
305 REM CLEAR SCREEN AGAIN
310 CLS
315 REM CLEAR ARRAY
320 FOR I=1 TO P
330 LET R(I)=0
340 NEXT I
395 REM LOOP FOR EACH NUMBER
400 FOR I=1 TO Z
410 LET J=0
415 REM CONVERT NUMBER TO BINARY
420 LET J=J+1
430 LET R(J)=R(J)+1
440 IF R(J)<2 THEN GO TO 470
450 LET R(J)=0
460 GO TO 420
465 REM PRINT NUMBER IF BIT IS ON
470 IF R(A)=1 THEN PRINT I.
480 NEXT I
485 REM END OF NUMBER LOOP
500 PRINT
505 REM ASK IF NUMBER HAS BEEN DISPLAYED
510 PRINT "IS THE NUMBER ON THIS PAGE?"
520 INPUT B
525 REM ACCUMULATE ANSWER IF YES
530 IF B=1 THEN LET S=S+T
540 LET T=T*2
550 NEXT A
555 REM END OF MAIN LOOP
595 REM DELAY
600 FOR I=1 TO 900

```

```

610 NEXT I
620 CLS
695 REM PRINT ANSWER
700 PRINT "YOUR NUMBER IS "S
705 REM ASK IF ANOTHER GO WANTED
710 PRINT
720 PRINT "DO YOU WANT ANOTHER GO?"
730 INPUT B
735 REM JUMP IF YES
740 IF B=1 THEN GO TO 200
750 STOP

```

Loading cassette data

ANOTHER solution to the ZX-80 problem of loading data from cassette is suggested by Tony Willgoose. He noticed that the input impedance of the ZX-80 is very large — presumably because it has a CMOS buffer — and realised that with the output capacitor of the tape recorder, there must be a very long time constant involved which would tend to make hash of data.

He solved the problem by connecting a 100Ohm resistor across the output of the tape recorder — or the input of the ZX-80. Since then, he says he has had 100 percent success. We feel that 100Ohms might load the output rather — it might be better to try 490Ohms.

Addition exercise

THIS program enables a user to practise simple addition and was submitted to us by the Regional Computer Centre at Bath University. Each time it is used, it generates a new sum and presents it. For each column, it asks first for the digit to write in to the answer and then for the digit to carry. This example shows the program at the stage of asking for the carry digit for the third column.

If a wrong digit is input at any stage, the program keeps asking until the correct one is input. When the sum is completed the user is asked: "another sum"?

```

530
098
178
644
50
22
WRITE-IN? 4
CARRY?

```

The number of rows and columns in the sum can be varied by changing statement numbers 110 and 111. R is the number of rows; C the number of columns. However, the number of rows should not be more than 10 — the program algorithm is valid only for R<10.

For a ZX-80 with 1Kbyte of RAM, the program occupies a large proportion of memory, so there is a limit to the overall size of the sum that can be handled. If statement numbers 100 and 101 are removed, the program works for up to four columns and six rows or three columns and eight rows, although it will run out of display space if a large number of incorrect answers are entered by the user.

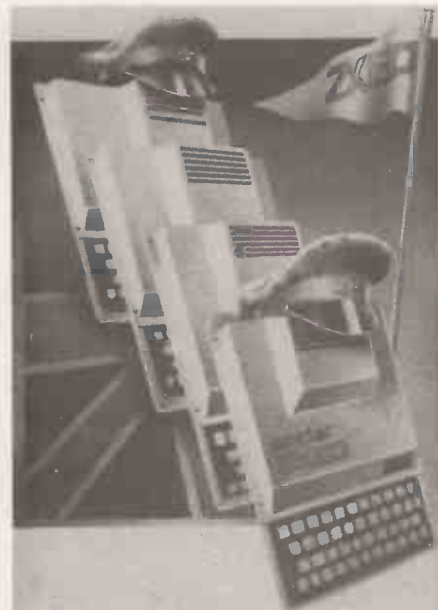

Three factors contribute to the amount of memory needed by a running program: the length of the program; the number of variables in the program, and the volume of text printed on the screen at any one time. The length of a program is increased very significantly by string variables or constants.

Thus, there tends to be a conflict between the objective of making an interactive program user-friendly and the need to keep the program small enough to fit into memory. Likewise REM statements increase program length significantly.

It should be noted that using fewer digits in the line numbers has very little effect in decreasing the length of the program. Line numbers at the beginning of lines are stored in two bytes irrespective of the magnitude of the numbers, so the only saving possible is where a line number appears in a GO TO or GO SUB statement. Obviously, if the volume of text appearing on the screen is proving critical, it is helpful to clear the screen whenever possible.

Sometimes after having run a program that uses most of the memory, it appears that the computer is not responding properly to new commands, and you may think that the program has been lost.

However, what may have happened is that running the program initialised enough variables to use all or most of the memory. This memory can be retained by pressing CLEAR.

In version one of the program, the digits to be added are held in the array S, and the write-in and carry digits are stored in W and C respectively. When the final answer to the sum is displayed, it appears as follows:

| | | | |
|-------------|-------------|-------------|-------------|
| | S(9) | S(5) | S(1) |
| | S(10) | S(6) | S(2) |
| | S(11) | S(7) | S(3) |
| | S(12) | S(8) | S(4) |
| <u>C(4)</u> | <u>W(3)</u> | <u>W(2)</u> | <u>W(1)</u> |
| C(4) | C(3) | C(2) | |

The subroutine to print this —
(continued on next page)

(continued from previous page)

statements 500 - 720 — is, however, complicated, because at earlier stages of the print-out, when the user has not yet added all the columns, the appropriate number of blanks has to be left in the write-in and carry rows. The information as to how many blanks to print-out is communicated to the print subroutine through the variable I.

In the second version of the program, the whole sum is held in the one array S. However, because blanks and dashes as well as digits have to be represented, the CODE of each character is held in the appropriate array element.

Thus a blank is represented as zero, a dash as 18, a zero as 28, a one as 19, and so on. In this case, the print subroutine is much more straightforward — each array element is converted to a character and then printed.

In the subroutine, also included is a feature to suppress the printing of the leading zeros — so that, for instance, 93 is not printed as 093.

The sum is represented in the array as follows:

| | | | | |
|-------|-------|-------|------|----------------|
| S(25) | S(17) | S(9) | S(1) | |
| S(26) | S(18) | S(10) | S(2) | |
| S(27) | S(19) | S(11) | S(3) | |
| S(28) | S(20) | S(12) | S(4) | |
| S(29) | S(21) | S(13) | S(5) | line of dashes |
| S(30) | S(22) | S(14) | S(6) | write-in |
| S(31) | S(23) | S(15) | S(7) | line of dashes |
| S(32) | S(24) | S(16) | S(8) | carry |

Although the print subroutine of the second version is much shorter, this is offset by longer initialisation — statements 200 - 275 — and more space being used in the array.

Both versions give an indication of how numbers larger than 32,767 can be handled by storing each digit separately. The algorithms for addition and subtraction are quite simple, but for multiplication and division they are more complicated.

Program details

| | | |
|--|------------|-----------|
| Initialise variables | statements | 110 — 117 |
| Generate sum | | 200 — 275 |
| For each column | | 300,395 |
| Print the sum so far | | 305 |
| Calculate correct write-in and carry | | 310 — 335 |
| Ask for write-in and test it | | 340 — 365 |
| Ask for carry and test it | | 370 — 390 |
| Print the completed sum | | 400,410 |
| Ask another sum?, and continue or stop | | 420 — 435 |
| Printing subroutine (Version 1): | | |
| Clear screen | | 500 |
| Print the numbers in the sum | | 510 — 540 |
| Print the first ruler-line | | 550 |
| Print the digits written-in so far | | 560 — 610 |
| Print the second ruler-line | | 620 |
| Print the digits carried so far | | 630 — 670 |
| Print another blank line and return | | 680,685 |
| Subroutine to print a ruler-line | | 700 — 720 |

Variables (Version 1):

C = the number of columns in the sum
 C() = array holding the carry digits
 I = loop counter denoting the column column current being added
 J,K = loop counters
 Q8 = variable to hold answer to "ANOTHER SUM?"
 R = number of rows in the sum

S() = array holding the sum
 S() = array holding the write-in digits
 Z = variable to hold answer to WRITE-IN? or CARRY?

Variables (Version 2):

C, Q8, R, S(), Z — as in version 1
 D = R + 4
 F = flag in print subroutine
 I,J,K = loop counters
 T = temporary variable to hold often-used expressions

VERSION 1 LISTING

```

100 REM "EXERCISE IN ADDITION"
      VERSION 1
101 REM COPYRIGHT 1980 U.BARRON
      SMURCC, BATH BA2 7AY

110 LET C=3
111 LET R=4
112 IF R>10 THEN STOP
113 DIM C(C+1)
114 DIM W(C)
115 DIM B(C+R)
116 LET C(I)=0
117 RANDOMIZE

200 FOR J=1 TO R+Q
210 LET B(J)=RND(10)-1
220 NEXT J

300 FOR I=1 TO C
305 GO SUB 500
310 LET W(I)=C(I)
315 FOR J=1 TO R
320 LET W(I)=W(I)+S(R+(I-1)+J)
325 NEXT J
330 LET C(I+1)=W(I)/10
335 LET W(I)=W(I)-C(I+1)*10
340 PRINT "WRITE-IN?";
345 INPUT Z
350 IF Z=W(I) THEN GO TO 365
355 PRINT Z;"?";
360 GO TO 345
365 PRINT Z
370 PRINT "CARRY?";
375 INPUT Z
380 IF Z=C(I+1) THEN GO TO 395
385 PRINT Z;"?";
390 GO TO 375
395 NEXT I

400 LET I=C+1
410 GO SUB 500
420 PRINT "ANOTHER SUM?"
425 INPUT Q8
430 IF CODE(Q8)=62 THEN GO TO 200
435 STOP

500 CLS
510 FOR J=1 TO R
515 PRINT " ";
520 FOR K=1 TO C
525 PRINT S(R+(C-K)+J);
530 NEXT K
535 PRINT
540 NEXT J
550 GO SUB 700
560 IF I<C+1 OR C(I)=0 THEN GO TO 575
565 PRINT C(C+1);
570 GO TO 590
575 FOR J=1 TO C+2-I
580 PRINT " ";
585 NEXT J
590 IF I=1 THEN GO TO 610
595 FOR J=1 TO I-1
600 PRINT W(I-J);
605 NEXT J
610 PRINT
620 GO SUB 700
630 IF I=C+1 THEN GO TO 655
635 FOR J=1 TO C+1-I
640 PRINT " ";
645 NEXT J

```

```

650 IF I=1 THEN GO TO 670
655 FOR J=1 TO I-1
660 PRINT C(I+I-J);
665 NEXT J
670 PRINT
680 PRINT
685 RETURN
700 FOR J=1 TO C+1
705 PRINT "-";
710 NEXT J
715 PRINT
720 RETURN

```

VERSION 2 LISTING

```

100 REM "EXERCISE IN ADDITION"
      VERSION 2
101 REM COPYRIGHT 1980 U.BARRON
      SMURCC, BATH BA2 7AY

110 LET C=3
111 LET R=4
112 IF R>10 THEN STOP
113 LET D=R+4
114 DIM S(D+(C+1))
117 RANDOMIZE

200 FOR I=1 TO R
205 LET S(C+D+I)=28
210 FOR J=0 TO C-1
215 LET S(I+J+D)=RND(10)+27
220 NEXT J
225 NEXT I
250 FOR I=1 TO C+1
255 FOR J=0 TO 1
260 LET S(I+D-3+J*2)=18
265 LET S(I+D-2+J*2)=0
270 NEXT J
275 NEXT I

300 FOR I=1 TO C
305 GO SUB 500
310 LET T=D*(I-1)+R+2
312 LET S(T)=S(T+2)-28
314 IF I=1 THEN LET S(T)=0
315 FOR J=1 TO R
320 LET S(T)=S(T)+S(T+J-R-2)-28
325 NEXT J
330 LET S(D*(I+1))=S(T)/10+28
335 LET S(T)=S(T)-10*(S(D*(I+1))-28)+28
340 PRINT "WRITE-IN?";
345 INPUT Z
350 IF Z=S(T)-28 THEN GO TO 365
355 PRINT Z;"?";
360 GO TO 345
365 PRINT Z
370 PRINT "CARRY?";
375 INPUT Z
380 IF Z=S(D*(I+1))-28 THEN GO TO 395
385 PRINT Z;"?";
390 GO TO 375
395 NEXT I

400 LET B(C+D+R+2)=S(C+D+R+4)
410 GO SUB 500
420 PRINT "ANOTHER SUM?"
425 INPUT Q8
430 IF CODE(Q8)=62 THEN GO TO 200
435 STOP

500 CLS
505 FOR J=1 TO R+4
510 LET F=1
515 FOR K=0 TO C
520 IF F=0 THEN GO TO 545
525 IF NOT S((C-K)*D+J)=28 THEN GO TO 540
530 PRINT " ";
535 GO TO 550
540 LET F=0
545 PRINT CHR$(S((C-K)*D+J));
550 NEXT K
555 PRINT
560 NEXT J
565 PRINT
570 RETURN

```





SORCERER

CP/M™
S100
Z80

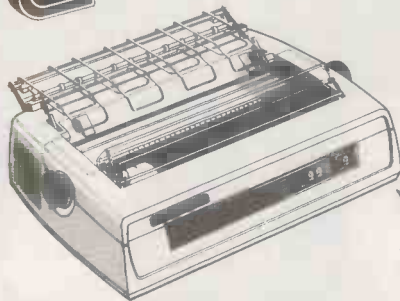
For the serious user:
**Business
Education
Amateur**

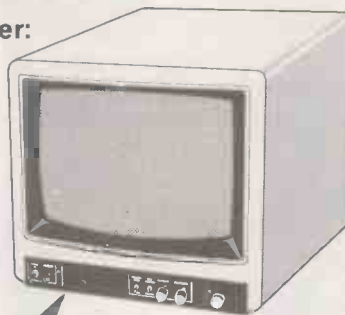

PIO + RS232/20ma serial O/P
Dual 1200 baud cassette O/P



Memory mapped
30 lines x 64 characters
upper/lower case + 128
programmable graphics



SORCERER
16-48K internal RAM
Z80 CPU, 4K monitor

Video or UHF

6 slot S100 expansion
(not illustrated)

ROMPAC



Micropolis 630K dual disk
CP/M or Micropolis MDOS

STANDARD SORCERER

- * Displays 30 lines of 64 characters - more than any other personal computer. 79 key stepped typewriter-style keyboard with separate numeric pad for fast data entry.
- * Plug in ROMPAC cartridges for programming languages, special applications (e.g. word processing) or creating a user's dedicated system. Sorcerer is supplied with 8K Microsoft BASIC ROMPAC
- * Composite video output for video monitor or UHF output for use with an unmodified TV set at nominal extra charge.
- * Z80 CPU with up to 48K RAM on-board.
- * 4K power-on monitor in ROM allowing machine code programming, batch processing, memory transfers and copying, alteration of memory locations, use of cassette files.
- * Dual 300 or 1200 baud cassette ports with motor control
- * Parallel I/O port and serial RS232 port for direct connection to printers or use as a terminal to a larger computer - no expensive 'extra' communications interfaces
- * Full upper/lower case ASCII characters plus 128 user programmable graphics (64 default to standard graphics symbols if undefined). Default graphics above ordinary characters on keytops.

16K £749.00 32K £799.00 48K £849.00

Expansion Capabilities

- * 6 slot S100 expansion for memory up to 56K RAM, disc drives (5¼" or 8") etc. Standard bus means that you are not dependent on equipment from a single manufacturer **£240.00**
- * Micropolis double density 5¼" drives with MDOS and Disc BASIC: First drive (incl. controller card) single 315K **£690.00**
Additional drives (max 4 drives/controller) 315K **£390.00**
- * FDM 180 Disk Unit: Micropolis Disk Drive, plugs directly into Sorcerer, does not require S100 Unit:
Single 315K Disk Drive (c/w CP/M and Microsoft BASIC) **£599.00**
Single 315K Add-on Disk Drive. **£450.00**
- * CP/M industry standard disk operating system **£75.00**
- * Development ROMPAC - Z80 assembler, loader, editor, debugger **£70.00**
- * EPROM PAC for loading dedicated software up to 16K **£35.00**
- * Configuring programs allow Sorcerer to be used as a 'dumb' terminal or, with CP/M, as an intelligent terminal.

Programming Languages

The following programming languages are available for CP/M:

Microsoft Disk BASIC interpreter (BASIC 80 - compatible compiler), CBASIC2 (compiled BASIC), FORTRAN 80 and COBOL-80, ALGOL 60 - A Z80 system with graphics, string handling and random-access filehandling.

All Exidy products are covered by 12 months warranty.
CP/M™ is a trademark of Digital Research.
All prices exclusive of VAT

THE WORDPROCESSING WIZARD!

Sorcerer's upper/lower case typewriter keyboard and unusually large display (30 lines of text; approximately equivalent to one double-spaced typed page) makes it ideal for word processing applications. The Exidy word processor PAC is a sophisticated screen editor and text formatter with automatic text wrap-around, left and right justification, proportional letter spacing (on disk only with Spinwriter) and many other formatting facilities. It can also search for and replace strings, move and merge blocks of text and a macro facility allows specification of tasks such as mail-merge letter typing. Letters and texts can be stored on cassette or disks (one disk will store approximately 300,000 characters and costs less than five pounds. 32K or 48K RAM is recommended.

Word Processor PAC **£120.00** Disk Version: **£118.75**

C.Itoh 8300 dot matrix printer -40, 80 and 120 characters per line on 9½" wide paper, 125 characters/second, upper/lower case, tractor feed, forms positioning **£499.00**

NEC Spinwriter solid font printer -variable horizontal and vertical spacing, proportional spacing, interchangeable fonts, carbon or fabric ribbon, 55 characters/second, paper up to 16" wide **£1,900.00**

Example system: 32K Sorcerer, video monitor, FDM 180 Disk Unit with CP/M and Microsoft BASIC, C.Itoh 8300 printer, Word Processor on disk and CP/M. **£2,225.00**

Business Software

Besides its word processing capabilities, Sorcerer can run a wide range of business software thanks to the widely used CP/M disk operating system available for the Micropolis disk drives. Programs available include:

Payroll: (requires CP/M and CBASIC2) **£250.00**
General Ledger, Job Costing, Accounts Receivable, Accounts Payable: (all require CP/M and CBASIC2) **£335.00 each**

For further information and list of dealers,
please contact the sole U.K. distributors.

GEOFF WILKINSON, Dept. PC.1

LIVEPORT

DATA PRODUCTS

The Ivory Works, St. Ives, Cornwall TR26 2HF
Telephone: (0736) 798157

PLEASE SEND DETAILS OF THE EXIDY RANGE/WORD PROCESSOR

NAME _____

ADDRESS _____

PC10

Buying Computers?

Commodore PET 32K
£675.75 plus VAT

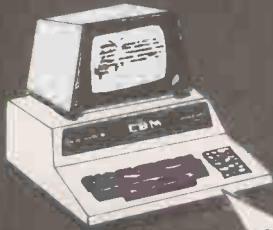

Sharp MZ-80K
£480.00 plus VAT



ITT 20/20 16K
£607.00 plus VAT



ACT 808 inc dual
disk drive
£3950.00 plus VAT

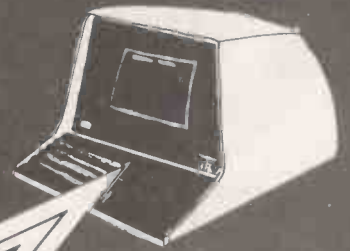

ACT 808 inc dual
disk drive
£3950.00
plus VAT

We'll give you more than a good deal

Under one roof in London's West End you can find:

HARDWARE:

A comprehensive range of hardware to meet most applications - and budgets, with terms to suit you.

SOFTWARE:

Probably the widest range of off-the-shelf software in the UK. Try out the packages and choose the one that suits you, or take advantage of our consultancy services and we will analyse, recommend, demonstrate, modify and install the programs for you.

CONSULTANCY SERVICES:

To apply micro computer systems to business, education or the home, make an appointment with our trained professionals for friendly advice based on extensive experience of discussing problems with many others like you.

MAINTENANCE AND REPAIR CLUB:

A maintenance and repair club that guarantees microcomputer users minimum downtime at very attractive premiums.

REFERENCE MATERIAL:

A library of publications covering all aspects of the microcomputer world,

including back issues of this and other important periodicals.

Whether you are an experienced micro user or a novice, looking for a system for the home, business or pleasure, the **LION MICROCOMPUTER CENTRE** is the single source to meet all your requirements.

CALL IN ANY TIME. We are open six days a week, for you to take advantage of the good deal you get when you buy from **LION**.

The above prices do not apply to account sales.



LION MICRO-COMPUTERS

SMALL COMPUTERS-TO MAKE YOUR BUSINESS BIGGER

Lion Computer Shops Ltd, Lion House, 227 Tottenham Court Road, London W1 (First Floor). Telephone: 01-637 1601. Telex: 28394 Lion G.

Open 9 to 6, Monday to Saturday (Thursday to 7).



• Circle No. 192

Program contents viewer

ANYONE who has played with Adventure and other machine-code game programs, will know how annoying it can be as you cannot easily see the contents of the program writes AS Whipples of West Molesey in Surrey. However, there is an indirect method I first tried on the Tandy Eliza program which is not on sale in the U.K.

Firstly, you load the concerned machine code program, then re-set the machine and type in the following short program:

```
10 REM LAST RESORT
20 CLS
30 FOR I = 1 TO 32767
40 PRINT CHR8(PEEK(1));
50 NEXT I
60 CLS:PRINT @ 390, "THAT'S ALL
  FOLKS"
70 END
```

After about three minutes of Level II Basic words, graphic characters and error messages appear on your screen, you will finally arrive at the program. In the case of Adventure, you will see the words to which it responds, and the rooms and objects in it, but in the case of Eliza you will see the foul language it answers and its appropriate responses.

Of course, this program should only be used as a last resort.

ESP computing

THIS program, called ESP was designed for a TRS-80 model 1 Level II, but should work on any standard Microsoft Basic if the instructions are suitably modified writes Edward Reid of Dublin. It uses about 3.5K of memory.

I decided on the idea for the program while I sat playing with a deck of cards. I found that if you accumulated the cards in the correct order, you could obtain a predetermined card at will.

When I started work on the program, I found that 52 was not a good number but that 48 and 64 were superior because they both divided evenly by four and then by four again which is what I needed for this game — $48 \div 4 \div 4 = 3$, $64 \div 4 \div 4 = 4$.

That meant I would have to accumulate 48, three times and 64, four times. I decided on 48 because of the screen space available and the time taken to pick 48 random numbers making sure that none was repeated.

The first time I tried the program, the sorting took around 2½ to three minutes.

```
100 REM *****
110 REM
120 REM
130 REM
140 REM *SETTING UP
  ARRAYS*
150 T=0
160 DIMA(50):DIMD(50):A(1)=0:D(1)=0
170 CLS
180 REM *SETTING UP INST.*
190 PRINT@465, "WHAT IS YOUR FIRST
  NAME ";
200 INPUT"";CS
210 CLS
220 PRINT:PRINT:PRINT
230 PRINT " THIS IS A GAME TO SHOW
  YOU THAT THE COMPUTER KNOWS
  EXACTLY"
```

TANDY FORUM is devoted to the Tandy TRS-80. Sometimes we will use it to pass on news about the TRS-80 but, above all, it is for users, and would-be users, of the well-established model I and now the new model II. With your tips, queries, moans and comments, this page can become a market-place for TRS-80 information.



```
240 PRINT " WHAT YOU ARE
  THINKING ALL THE TIME."
250 PRINT:PRINT
260 PRINT " ALL YOU HAVE TO DO IS
  PICK A NUMBER BETWEEN 0-49
  AND IT WILL TELL YOU WHAT
  YOUR NUMBER WAS AFTER ONLY
  THREE SIMPLE QUESTIONS."
270 PRINT:PRINT:PRINT " THE
  COLUMNS ARE NUMBERED AS
  BELOW ."
280 PRINT
290 PRINT " 1 "" 2 "" 3 "" 4 ""
300 REM *PUTTING ON THE
  BORDER*
310 FORX = 1TO127
320 SET(X,1):SET(X,47)
330 NEXTX
340 FORY = 1TO47
350 SET(1,Y):SET(127,Y)
360 NEXTY
370 REM *PICKING THE FIRST
  27 RND*
380 R = 27:GOSUB1010
390 REM *FILLING IN WITH
  POINTS*
400 FORA = 2TO46
410 FORX = 1TO127
420 SET(X,A)
430 NEXTX
440 NEXT A
450 REM *BACK TO PRINTING*
460 PRINT @228,
470 PRINT@340, "E.S.P."
480 PRINT@468, "BY EDWARD REID"
490 PRINT@596, "A BASIC PRODUT" =
500 PRINT@724, "FOR A TRS80"
510 REM *PICKING THE NEXT
  18 RND*
520 R = 18:GOSUB1010
530 REM *PICKING THE LAST
  3 RND*
```

```
540 R = 3
550 CLS:PRINT@469, "SORTING"
560 GOSUB1010
570 REM *HOW MANY TIMES
  LEFT TO GO*
580 FORU = 1TO3
590 REM *SETTING UP
  NUMBERS*
600 CLS
610 PRINT@12, "REMEMBER THAT
  NUMBER ";CS:PRINT
620 FOR X = 1 TO 12
630 PRINT A(X),A(X + 12),A(X + 24),A
  (X + 36)
640 NEXTX
650 PRINT:INPUT "WHICH COLUMN IS
  YOUR NUMBER IN ";Q
660 CLS
670 Z = 0
680 FORX = 1TO4
690 REM *WHICH COLUMN
  FIRST*
700 IF Q = 1 THEN V = 0 : GOTO760
710 IF Q = 2 THEN V = 3 : GOTO760
720 IF Q = 3 THEN V = 6 : GOTO760
730 IF Q = 4 THEN V = 9 : GOTO760
740 GOTO650
750 REM *RESORTING
  NUMBERS*
760 FORY = VTO11:Z = Z + 1:D(Z) =
  A(X + 4*Y)
770 NEXT Y
780 IFV = 0GOTO800
790 V = V - 1:FOR Y = 0TOV:Z = Z + 1:D(Z)
  = A(X + (4*Y)):NEXT Y
800 NEXT X
810 REM *FROM D TO A*
820 FORS = 1TO49
830 A(S) = D(S)
840 NEXTS
850 NEXTU
860 REM *DID YOU GET IT
  RIGHT*
870 PRINT@468, "YOUR NUMBER WAS";
  A(1);"!"
880 PRINT@595, "WAS I RIGHT (Y OR H)
  ";
890 INPUT"";BS
900 IFBS = "Y" THEN GOTO940
910 IFBS = "N" THEN CLS:PRINT@580,
  CS;" YOU ARE A LITTLE CHEAT OR
  A ROTTEN TYPIST !!!":FOR
  X = 1TO30
  00:NEXTX
920 CLS
930 REM *TRY AGAIN*
940 CLS:PRINT@584,CS;"DO YOU WANT
  TO TRY AGAIN (Y OR N)";
950 INPUT"";AS
960 IF AS = "Y" GOTO580
970 CLS:PRINT@590, "WELL IF THAT'S
  THE WAY YOU THINK !!!":FORX =
  1TO3000:NEXTX
980 CLS:PRINT596, "GOOD BYE!"
990 FORX = 1TO2500:NEXTX:CLS:END
1000 REM *COMPARING RND
  NUMBERS*
1010 FORX = 1TOR
1020 A = RND(48)
1030 FOR Y = 1TOT
1040 IFR = 3 THEN H = A + 35:SET(H,19);
  SET(H,24)
1050 IF A = A(Y) THEN GOTO1020
1060 NEXT Y
1070 T = T + 1
1080 A(T) = A
1090 NEXTX
1100 RETURN
1110 REM *THE END*
```

The New DDP Video Monitor . . .



. . . that's scientifically proven . . .

. . . to save operational error . . .

At last, from DDP, here's the video monitor that eyes and ears all over Britain have been waiting for. Eyes, because as alternatives to black and white tubes, green and revolutionary new orange tubes are optionally available. Ears, because now you're going to enjoy the sound of silence – from your service engineer.

But to take first things first, we mention a few colourful facts. After Scandinavian scientists had proved how close-range human vision could benefit from working with orange light, orange tubes quickly replaced green as standard for most Scandinavian videos. A few years behind, we in Britain still belong to the Green Screen Club – but as indifferent members when it comes to monitors. With DDP's new monitor, however, you can experience Scandinavian sophistication. And all the difference it makes to operating profits when allowance is made for operator fatigue.

Inside our monitor you'll discover its second big advantage. More easily overlooked, but just as important to long-term operating profitability is the unique modular circuitry. The resin-block circuits will outperform conventional systems and delight engineers when, aeons into the future, servicing is eventually required. And the cost? Bearing in mind the big 12 inch screen, you'll be amazed at our recommended retail price of £165 (ex. VAT). Generous DDP volume discounts are equally astonishing, but most surprising of all is how quickly we can deliver. To find this out, though, you'll need to make a phone call . . .

. . . and, therefore, your time . . .

. . . and money.

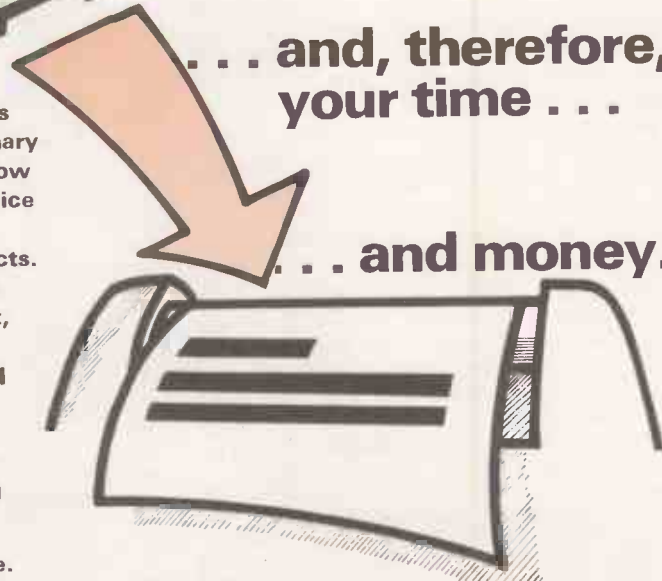

DDP Video Monitor Orderline: (0268) 727563



Distributed Data Processing Ltd.

Essex House, Cherrydown, Basildon, Essex SS16 5AQ

• Circle No. 193

Backspace for Superboard

OSI Superboard users like myself must grow extremely frustrated by the lack of a true backspace — shift gives only a series of dashes complains David Harrison of Bury.

I have thus written a short program to turn the rub-out key — previously unused by Basic — into a backspace and delete key. The program is as follows and should be entered via the monitor.

```

ØPDF 2ØBAFF JSR FFBA ; GET KEY
ØFE2 C97F CMP 7F ; RUB-OUT?
ØFE4 FØØ1 BEQ Ø1
ØFE6 6Ø RTS ; NO-
; RETURN AS
; NORMAL
ØFE7 CA DEX ; DECRE-
; MENT TEXT
; POINTER
ØFE8 1Ø Ø2 BPL Ø2 ; NO TEXT?
ØFEA E8 INX ; RESTORE
; IF SO
ØFEB 6Ø RTS ; AND
; RETURN
ØFEC ACØØØ2 LDY Ø2ØØ ; GET
; CURSOR
; LOC-
; ATION
ØFEF A92Ø LDA 2Ø ; SPACE =
; 82Ø
ØFFI 99ØØD3 STAD3ØØ,Y ; BLANK
; OUT CHAR-
; ACTER
ØFF4 CEØØØ2 DEC Ø2ØØ ; DECRE-
; MENT
; CURSOR
; LOCATION
ØFF7 88 DEY
ØFF8 A95F LDA 5F ; CURSOR
; CHAR-
; ACTER =
; 85F
ØFFA 99ØØD3 STA D3ØØ,Y ; DRAW
; CURSOR IN
; NEW
; LOCATION
ØFFD A97F LDA 7F ; RESTORE A
ØFFF 6Ø RTS ; AND
; RETURN
    
```

It is written to run on a 4K machine — memory size of 4,062 — but will re-locate with no changes. It is brought into operation by altering the input vector to point to it by

POKE 536, 223:POKE 537, 15

I am thinking of making the very simple and obvious modification to convert my microprocessor to run on 2MHz. I would appreciate, however, if someone could answer these two questions for me.

I presume my 6502 will not run at 2MHz, would I need to purchase a 6502A?

Is my memory fast enough? Considering how many people seem to have made this conversion, it is, I presume, no major problem.

Graphics display

THIS routine creates a fascinating graphics display on your television, ideal for impressing friends at parties or computer exhibitions writes Paul Kaufman of Edgware, Middlesex. The screen is divided into four quadrants.

The program goes through each location in the top-left quadrant and increments its.

The bulk of the program is taken up by

THE 6502 SPECIAL is dedicated exclusively to the exchange of information between 6502 users. It is up to you, the reader, to help establish this page with your ideas, problems and guidance for other 6502 users. Please mark your letters 6502 Special. We pay £5 for each contribution published.

checking routines to ensure the program stays within the bounds of the screen. There are two subroutines used, one to reflect a graphics byte and the other to invert the byte.

```

0040 00 TLLO BYTE )200
0041 00 TLHI BYTE )
0042 00 TRLO BYTE )21F
0043 00 TRHI BYTE )
0044 00 BLLO BYTE )3EØ
0045 00 BLHI BYTE )
0046 00 BRLO BYTE )3FF
0047 00 BRHI BYTE )
0048 00 TEMP1 BYTE )
0049 00 TEMP2 BYTE )
0400 A902 INIT LDA #2
; set up screen
0402 8541 STA TLHI
; pointers
0404 8543 STA TRHI
0406 A900 LDA #0
0408 8540 STA TLLO
040A A8 TAY
040B A91F LDA #1F
040D 8542 STA TRLO
040F A9EØ LDA #EØ
0411 8544 STA BLLO
0413 A9FF LDA #FF
0415 8546 STA BRLO
0417 A9Ø3 LDA #Ø3
0419 8545 STA BLHI
041B 8547 STA BRHI
041D B14Ø LOOP LDA (TLLO),Y
041F 18 CLC
0420 69Ø1 ADC #1
; Increment top left
0422 914Ø STA (TLLO),Y
; quadrant
0424 2Ø8AØ4 JSR REFLECT
; reflect byte
0427 9142 STA (TRLO),Y
; update top right
0429 2ØA8Ø4 JSR INVERT
; invert it
042C 9146 STA (BRLO),Y
; update bottom right
042E 2Ø8AØ4 JSR REFLECT
; reflect it again
0431 9144 STA (BLLO),Y
; update bottom left
0433 A54Ø SCAN LDA TLLO
; increment top left
0435 18 CLC
; scan pointer
0436 69Ø1 ADC #1
0438 854Ø STA TLLO
043A 29ØF AND #ØF
043C DØØ7 BNE CONT1
043E A54Ø LDA TLLO
044Ø 18 CLC
0441 691Ø ADC #1Ø
0443 854Ø STA TLLO
0445 A542 CONT1 LDA TRLO
; increment top right
0447 38 SEC ; scan pointer
0448 E9Ø1 SBC #1
044A 8542 STA TRLO
044C 29ØF AND #ØF
044E C9ØF CMP #ØF
045Ø DØØ7 BNE CONT2
0452 A542 LDA TRLO
0454 18 CLC
0455 693Ø ADC #3Ø
0457 8542 STA TRLO
0459 A544 CONT2 LDA BLLO
045B 18 CLC
045C 69Ø1 ADC #1
045E 8544 STA BLLO
046Ø 29ØF AND #ØF
    
```

```

0462 DØØ7 BNE CONT3
0464 A544 LDA BLLO
0466 38 SEC
0467 E93Ø SBC #3Ø
0469 8544 STA BLLO
046B A546 CONT3 LDA BRLO
; increment bottom right
046D 38 SEC
; scan pointer
046E E9Ø1 SBC #1
047Ø 8546 STA BRLO
0472 29ØF AND #ØF
0474 C9ØF CMP #ØF
0476 DØØ7 BNE CONT4
0478 A546 LDA BRLO
047A 38 SEC
047B E91Ø SBC #1Ø
047D 8546 STA BRLO
047F ADFØBF CONT4 LDA GON
; switch on graphics
0482 A2ØØ LDX #Ø
; delay — to slow things
0484 CA LOOP1 DEX
; down a bit
0485 DØFD BNE LOOP1
0487 4C1DØ4 JMP LOOP
048A 8548 REFLECT STA TEMP1
; this subroutine reflects
048C 18 CLC
; a graphics byte (reverses it)
048D 2A ROL
048E 29AA AND #AA
049Ø 8549 STA TEMP2
0492 A548 LDA TEMP1
0494 18 CLC
0495 2A ROL
0496 69ØØ ADC #ØØ
0498 2955 AND #55
049A 18 CLC
049B 6A ROR
049C 6A ROR
049D 1ØØ2 BPL SKIP
049F 49CØ EOR #CØ
04A1 9ØØ2 SKIP BCC STORE
04A3 Ø98Ø ORA 8Ø
04A5 Ø549 STORE ORA TEMP2
04A7 6Ø RTS
04A8 8548 INVERT STA TEMP1
; this subroutine inverts
04AA 18 CLC
; a graphics byte (turns it upside down)
04AB 29Ø3 AND #Ø3
04AD 6A ROR
04AE 6A ROR
04AF 6A ROR
04BØ 8549 STA TEMP2
04B2 A548 LDA TEMP1
04B4 29CØ AND #CØ
04B6 18 CLC
04B7 2A ROL
04B8 2A ROL
04B9 2A ROL
04BA Ø549 ORA TEMP2
04BC 8549 STA TEMP2
04BE A548 LDA TEMP1
04CØ 18 CLC
04C1 29CØ AND #ØC
04C3 2A ROL
04C4 2A ROL
04C5 Ø549 ORA TEMP2
04C7 8549 STA TEMP2
04C9 A548 LDA TEMP1
04CB 293Ø AND #3Ø
04CD 18 CLC
04CE 6A ROR
04CF 6A ROR
04DØ Ø549 ORA TEMP2
04D2 A2ØØ LDX #Ø
04D4 CA DEL DEX
04D5 DØFD BNE DEL
04D7 6Ø RTS
    
```

& Computers Peripherals

Leading-make hardware
at hard-to-beat prices

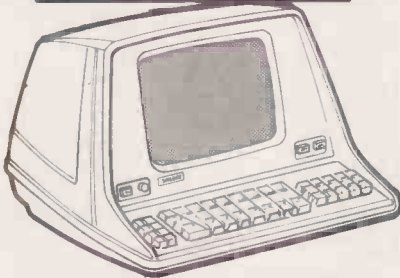
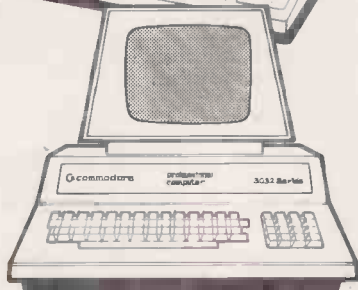
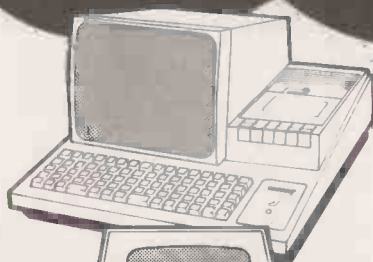

For full retail price list and
Conditions of Sale relating to these
offers, contact

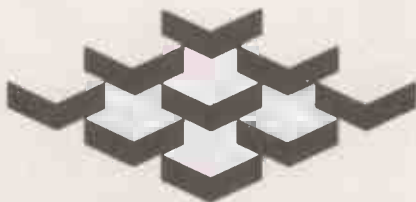

HB COMPUTERS

22 Newland Street
Kettering
Northamptonshire
Telephone 0536 520910
Telex 341297

| Model | User Ram | £ |
|-----------------------|---|---------|
| Sharp MZ80K | | |
| 20K | 6K | 380.00 |
| 36K | 22K | 423.00 |
| 48K | 34K | 475.00 |
| MZ80FD | Twin floppy disk drive | 650.00 |
| MZ80P3 | Matrix Printer | 431.00 |
| MZ801/0 | Expansion Interface | 83.00 |
| PC1211 | Pocket Computer | 83.25 |
| CE121 | Cassette Interface for PC1211 | 11.75 |
| Commodore | | |
| 2001-8 | Integral Cassette/small keyboard | 367.00 |
| 3008 | 8K with full size keyboard | 389.00 |
| 3016 | 16K with full size keyboard | 454.00 |
| 3032 | 32K with full size keyboard | 600.00 |
| 3040 | Twin 5¼" Disk drive | 600.00 |
| 3022 | 80 Col. 93cps Tractor printer | 367.00 |
| 3023 | 80 col. 93cps Friction printer | 325.00 |
| C2N | Add on cassette deck | 48.00 |
| | Computer to disk cable | 18.00 |
| | Disk to printer cable | 22.00 |
| ACT 800 Series | | |
| ACT 808 | Computer and 800K disk system | 2950.00 |
| ACT 824 | Computer and 2.4M disk system | 3750.00 |
| ACT 400 | 400K PET disk | 625.00 |
| ACT 800 | 800K PET disk | 795.00 |
| ACT 1.6 | 1.6M PET disk | 995.00 |
| Printers | | |
| | Teletype 43 Pinfeed. 30cps | 775.00 |
| | Decwriter LA34 Friction Feed. 30cps | 775.00 |
| | Qume Sprint 5 45 RO | 1518.00 |
| | Qume Sprint 5 55 RO | 1605.00 |
| | Qume Sprint 5 45 SKR | 1695.00 |
| | Qume Sprint 5 55 KSR | 1810.00 |
| | Ricoh RP 1600 Daisywheel (PET interface) | 1025.00 |
| | Ricoh RP 1600 Daisywheel (HITYPE interface) | 900.00 |
| | Centronics 702 | 1300.00 |

• Circle No. 194

Patriotic routine

HERE IS a short routine from Roger Cullis of Cranleigh, Surrey, which, using high-resolution graphics, traces the Union Jack and then plays the National Anthem through the Apple Speaker.

```

1000 REM UNION JACK
1010 HGR2
1020 REM SET HGR COLOURS
1030 W = 7:BL = 2:R = 6
1040 REM COORDINATES OF APICES
1050 DATA 120,84,129,0
1060 DATA 150,84,159,0
1070 DATA 160,75,279,84
1080 DATA 160,105,279,114
1090 DATA 159,105,150,190
1100 DATA 129,105,120,190
1110 DATA 119,114,0,105
1120 DATA 119,84,0,75
1130 DATA 119,70,9,0,119,0
1140 DATA 160,64,160,0,262,0
1150 DATA 169,74,279,5,279,74
1160 DATA 177,115,279,115,279,179
1170 DATA 161,120,271,190,161,190
1180 DATA 119,125,119,190,17,190
1190 DATA 110,115,0,184,0,115
1200 DATA 101,74,0,74,0,11
1210 DATA 119,59,27,0,119,0
1220 DATA 160,59,160,0,252,0
1230 DATA 187,74,279,15,279,74
1240 DATA 187,115,279,115,279,174
1250 DATA 160,130,252,190,160,190
1260 DATA 119,130,119,190,27,190
1270 DATA 92,115,0,174,0,115
1280 DATA 92,74,0,74,0,15
1290 REM CONSTRUCT FLAG
1300 HCOLOR=R: HPLOT 0,0: CALL 62454:
HCOLOR= 0: HPLOT 0,191 TO 2
79,191
1310 HCOLOR= W
1320 FOR J = 0 TO 7
1330 READ XA,YA,XB,YB
1340 IF Z > 1 THEN GOTO 1400
1350 FOR X = XA TO XB
1360 HPLOT X,YA TO X,YB
1370 NEXT
1380 Z = Z + 1
1390 GOTO 1560
1400 IF Z > 3 THEN GOTO 1460
1410 FOR Y = YA TO YB
1420 HPLOT XA,Y TO XB,Y
1430 NEXT
1440 Z = Z + 1
1450 GOTO 1560
1460 IF Z > 5 THEN GOTO 1520
1470 FOR X = XA TO XB STEP - 1
1480 HPLOT X,YA TO X,YB

```

Paddle Draw.

```

?SYNTAX ERROR
JLIST
10 REM ***** COPYRIGHT *****
20 REM ***** BRIAN WALL *****
30 REM ***** MAY 1980 *****
40 HGR2
50 POKE - 16368,0
60 HIMEM: 16384
70 HCOLOR= 0
80 A = PDL (0):B = PDL (1)
90 A = (A * 1.4)
100 REM =====LINE 90 IS FOR ITT'S ONLY
110 REM DITTO THE OTHER SIMILAR LINES
120 IF B > 191 THEN B = 191
130 HPLOT A,B
140 A1 = PDL (0):B1 = PDL (1)
150 A1 = (A1 * 1.4)
160 IF B1 > 191 THEN B1 = 191
170 A = A2:B = B2
180 IF B > 191 THEN B = 191
190 HPLOT A,B TO A1,B1
200 A2 = PDL (0):B2 = PDL (1)
210 A2 = (A2 * 1.4)
220 IF B2 > 191 THEN B2 = 191
230 HPLOT A1,B1 TO A2,B2
240 P = PEEK ( - 16286)
250 IF P > 127 THEN HCOLOR= 0: HPLOT A1,B1 TO A2,B2:
HCOLOR= 3: HPLOT A1,B1: GOTO 200
260 R = PEEK ( - 16287)
270 IF R > 127 THEN 320
280 Q = PEEK ( - 16384): IF Q > 127 THEN 40
290 POKE - 16368,0
300 GOTO 140
310 STOF
320 REM
330 M = PDL (0):N = PDL (1)
340 M = (M * 1.4)
350 IF N > 191 THEN N = 191
360 HCOLOR= 3: HPLOT M,N: HCOLOR= 0
370 C = PDL (0):D = PDL (1)
380 C = (C * 1.4)
390 IF D > 191 THEN D = 191
400 HPLOT M,N TO C,D
410 R = PEEK ( - 16287): IF R > 127 THEN 330
420 HCOLOR= 3
430 A1 = PDL (0):B1 = PDL (1)
440 A1 = (A1 * 1.4)
450 A2 = C:B2 = D
460 GOTO 170
?SYNTAX ERROR
JLIST
5 REM --- SIMPLE ANIMATION ---
20 HGR
30 PRINT CHR$ (4);"BLOAD PICTURE A,A$2000"
40 HGR2
50 PRINT CHR$ (4);"BLOAD PICTURE B,A$4000"
60 FOR I = 1 TO 150: NEXT I
70 POKE - 16300,0
80 FOR I = 1 TO 150: NEXT I
90 POKE - 16299,0
100 GOTO 60

```

This section is open to the Apple user. In every issue we hope to print ideas, hints and comments about the Apple and its suppliers. They must come from you, so write and tell us what you know.



```

1490 NEXT
1500 Z = Z + 1
1510 GOTO 1560
1520 FOR Y = YA TO YB STEP - 1
1530 HPLOT XA,Y TO XB,Y
1540 NEXT
1550 Z = Z + 1: IF Z = 8 THEN Z = 0
1560 NEXT
1570 FOR I = 0 TO 1
1580 FOR J = 0 TO 7
1590 READ XA,YA,XB,YB,XC,YC
1600 IF Z > 1 THEN GOTO 1660
1610 POK X = XB IU XC
1620 HPLOT XA,YA TO X,YB
1630 NEXT
1640 Z = Z + 1
1650 GOTO 1820
1660 IF Z > 3 THEN GOTO 1720
1670 FOR Y = YA TO YC
1680 HPLOT XA,YA TO XB,Y
1690 NEXT
1700 Z = Z + 1
1710 GOTO 1820
1720 IF Z > 5 THEN GOTO 1780
1730 FOR X = XB TO XC STEP - 1
1740 HPLOT XA,YA TO X,YB
1750 NEXT
1760 Z = Z + 1
1770 GOTO 1820
1780 FOR Y = YB TO YC STEP - 1
1790 HPLOT XA,YA TO XB,Y
1800 NEXT
1810 Z = Z + 1: IF Z = 8 THEN Z = 0
1820 NEXT
1830 HCOLOR= BL
1840 NEXT

```

```

1850 REM SET MUSIC PROGRAM
1860 POKE 770,173: POKE 771,48: POKE 772,192:
POKE 773,136: POKE 774,208
1870 POKE 775,5: POKE 776,206: POKE 777,1:
POKE 778,3: POKE 779,24 0
1880 POKE 780,9: POKE 781,202: POKE 782,208:
POKE 783,245: POKE 784,174
1890 POKE 785,0: POKE 786,3: POKE 787,76:
POKE 788,2: POKE 789,3
1900 POKE 790,96: POKE 791,0: POKE 792,0
1910 REM PITCH AND LENGTH OF NOTES
1920 DATA 128,80,128,80,114,80
1930 DATA 136,120,128,40,114,80
1940 DATA 102,80,102,80,96,80
1950 DATA 102,120,114,40,128,80
1960 DATA 114,80,128,80,136,80
1970 DATA 128,80,128,40,114,40,102,40,96,40
1980 DATA 86,80,86,80,86,80
1990 DATA 86,120,96,40,102,80
2000 DATA 96,80,96,80,96,80
2010 DATA 96,120,102,40,114,80
2020 DATA 102,120,96,40,102,40,114,40,128,40
2030 DATA 102,120,96,40,86,80
2040 DATA 77,40,96,40,102,80,114,80
2050 DATA 128,240,0,0
2060 READ I,J: IF J = 0 THEN END
2070 POKE 768,I: POKE 769,J: CALL 770
2080 REM PAUSE BETWEEN NOTES
2090 FOR X = 0 TO 100:X = X + 1: NEXT
2100 GOTO 2060

```

Paddle Draw

PADDLE DRAW is an advanced version of Etch-A-Sketch in high-resolution and is submitted by Brian Wall of St Helier, Jersey.

For simple animation, you need a minimum of 24K, as it uses both high-resolution pages. Run Paddle Draw and draw a simple picture, say, a face. Without going to text, type Control C and save the picture on disc as PICTURE A. Still blind, delete line 40 and re-run the program. Now you can carefully add or change a small section of your picture, say, the mouth or an eye. □

ALL ABOUT PET...

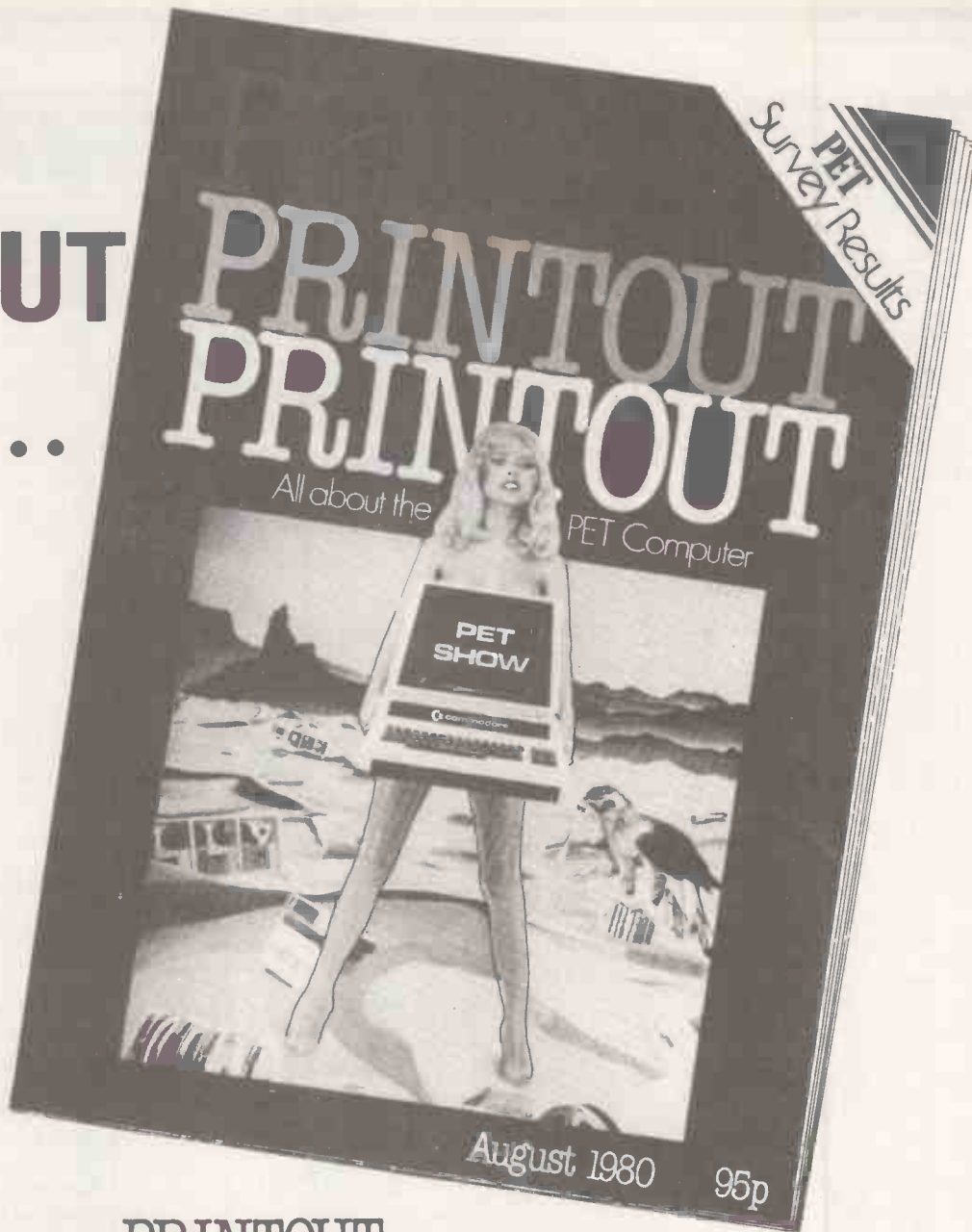

TEN TIMES A YEAR **PRINTOUT** PUBLISHES THE LATEST NEWS FROM THE FAST-MOVING WORLD OF THE CBM/PET.

In it you will find authoritative reports on the latest hardware, unbiased program reviews and a wealth of programming hints and listings. Whether you are a complete beginner or a hardened enthusiast, PRINTOUT is for you. Try a copy of the latest issue and see for yourself.

PRINTOUT's hardware and software reviews could save you a small fortune—we never pull our punches, especially about business software. PRINTOUT also tells you about the latest peripherals—speech synthesisers, voice recognition, high resolution graphics, even colour!

PRINTOUT can help solve your programming problems too; each issue we publish pages of readers questions with answers by our resident panel of PET experts. PRINTOUT is professionally produced, lavishly illustrated on glossy paper and packed with information. Last issue ran to 40 pages.

PET is the trademark of Commodore Subscriptions are for a full volume only and start with the first issue of that volume.

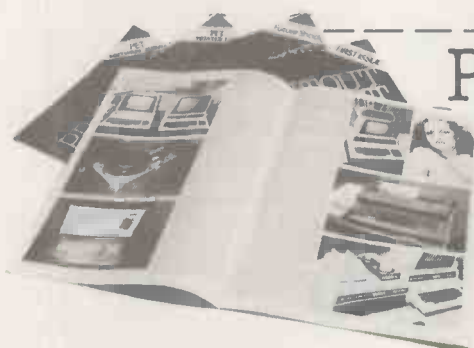

PRINTOUT Greenacre, North Street, Theale, Berks RG7 5EX

I enclose: 95p for the latest issue £9.50 for one years subscription (UK only)
 £14.50 for one years subscription (o'seas) £10.50 for one years subscription (Eire)

My name is

My address is

Post code

PC10

• Circle No. 195

The personal computer book

By Robin Bradbeer, published, 1980, by Input Two-Nine. 220 pages A5, available in the U.K. from good bookshops, price £5.25. ISBN 0 905897 56 0.

ROBIN BRADBEER is well known in the U.K. as a freelance writer on personal computing. In this book, he aims to provide the novice with a straightforward introduction to personal computers and he succeeds admirably.

Computing is a new discipline, high technology and with quite a strong U.S. contribution. All those factors combine to produce a fog of jargon, acronyms and reference numbers in which even experienced professionals occasionally lose themselves.

Above all, the newcomer needs a guide to the fundamentals of ideas, words and equipment. Everything necessary will probably appear in any year's issues of *Practical Computing*, but Robin Bradbeer's book provides all the information in one place, in a sensible order and in a consistent, clear style.

Chapter 1 is called What's it all about? and is a very general introduction to the past, present and future of computing. Chapter 2, Where do I start?, contains 10 useful hints on how to begin. Chapter 3, The computer — what is it? How does it work?, describes computer hardware and Chapter 4, How do I talk to the computer?, describes software and programming languages.

Chapter 5, What's in the boxes? describes peripherals and the longest chapter, 6, What can I buy?, pictures and summarises commercially-available computers and peripherals for less than £100 to more than £2,000 and advises on how to choose a system. The final chapter, rather pathetically entitled What can I do with it?, describes applications.

Eight appendices add to the book's value as a reference source once the reader has bought a system, describing binary, Octal, Hexadecimal and ASCII; bus standards and RS232C; manufacturers and U.K. distributors of equipment; U.K. computer clubs;



magazines in English; selected computer books — an annotated bibliography; a glossary and some hints on building systems from kits.

The two main criticisms which may be levelled at the book are that it is inevitably rather superficial, and that it will become increasingly out of date. Neither consideration should deter a novice considering buying the book since the information can be extended easily and kept up to date by reading.

Conclusions

● **Highly recommended for the newcomer to computing, but probably not worth buying if you have been reading magazines for a year or so and understanding them.**

● **With Christmas approaching, it could be an ideal present for intelligent nieces and nephews — if you are thinking of buying an expensive system you could even send a copy to your bank manager.**

Martyn Thomas

Data structure techniques

By T A Standish, 447 pages with index, bibliography and exercises. Published by Addison-Wesley. £13.60.

AT FIRST sight, it is a formidably academic book, smothered in formulae and equations in symbolic logic. However, the persevering reader will find a good many useful nuggets among the academic fairy gold. Standish deals in a sensible way with the progress made in developing digital computers to store and work with data from the outside world.

A quick glance at the contents page reveals the ground he covers: stacks, linked trees, hashing, circular lists, garbage

collection, decision tables, fast pattern matching, encryption and indexed sequential.

It is an invaluable work for consulting before embarking on a new project, simply to see what others have done when faced with a similar kind of problem.

For instance when it arrived, I was thinking about the problems of parsing natural English. Two gems appeared immediately — Zipf's law, and the Boyer-Moore fast string-matching algorithm. Zipf tells us the relative frequencies of words in ordinary English text.

The Boyer-Moore string matching algorithm looks for a substring P in a larger string S. The idea is to lay P against S, sliding it to the right, while searching S for matches to the left, starting at the right hand end of P.

Conclusions

● **An extremely useful book, highly recommended.**

Peter Laurie,

The ZX-80 Companion

By Bob Maunder and Terry Trotter, LINSAC, 1980, pp.5-87. Price £7.50.

MAUNDER and Trotter have been quick off the mark in producing this companion volume for ZX-80 users. Roughly, the contents of this short work are as follows: approximately five pages devoted to operation of the ZX-80; nine pages on the theory of computing and programming; 26 pages on ZX-80 Basic; 12 pages on ZX-80 construction and hardware; 16 pages describing five short programs and a six-page appendix listing the ZX-80 operation codes and characters corresponding to the bit patterns, 00000000 to 11111111.

The text which is typed on A4 pages also contains full-page black and white pictures of the ZX-80 in unusual poses. There is no index.

The reader may wonder how it compares to the ZX-80 operating manual which is included in the price of the ZX-80. Both volumes contain an adequate description of how to operate the ZX-80, but the ZX-80 Operating Manual is just a subtitle of A course in Basic programming.

It contains a much more comprehensive account of ZX-80 Basic than that found in the ZX-80 Companion, as well as being an introduction to computing and programming with several illustrative examples programmed in ZX-80 Basic, and it has a reasonable index at the back.

Maunder and Trotter do not give much more information on construction and assembly than can be found in the assembly instructions which come with the kit. There remains a gap here which could be filled usefully by simply soldering instructions.

Our ZX-80 was constructed by members of staff in a university computing centre with very little or no experience in hardware. Maunder and Trotter positively discourage the construction of the kit by the inexperienced.

I disagree completely with them on this point; experience gained in construction enables the users to appreciate firsthand the ZX-80 architecture. ZX-80s constructed from kit also have the advantage that maintenance is simplified as each integrated circuit is socket-mounted and, therefore, removed easily for testing and replacement.

The Companion notes on ZX-80 hardware are rather brief — nine pages only. The ZX-80 hardware manual included with the ZX-80 will no doubt cover all the material in much greater depth.

Conclusions

● **There are some informative and helpful comments in the ZX-80 Companion, but they may not be apparent to the reader as they are lost in the over long text.**

● **It is easy for the inexperienced to fall unwittingly into bad company and certainly any volume which claims to be a ZX-80 Companion is tempting.**

● **I cannot recommend a book for £7.50 which repeats much of what is contained in literature supplied with the ZX-80.**

● **For about the same money, you could buy the paperback edition of Donald Knuth's *Fundamental Algorithms* — a companion for the rest of your programming life.**

Cornelia Boldyreff

It's The Mu-pet Show!



Multi-User PET (Mu-pet) links 3-8 PET computers to one Commodore disc drive and a printer.

Mu-pet is very good news indeed for those PET users wanting a multi-user computer system and who, up until now, have run up against a budgetary brick wall.

Mu-pet delivers the goods at very low cost... which is one of the reasons it's become the world's biggest selling multi-PET system. Precisely engineered in the U.S. and Canada, Mu-pet makes the most of PET computers - *without the need for program changes.*

£595 is all it costs for a standard Mu-pet system that links three PET computers to a single Commodore disc drive and a printer. The cost of linking more PET computers, up to a maximum of eight, is £125 for each addition.

All machines have access to the disc drive and printer. The hardware which all runs via the IEEE bus has been so well designed that each PET thinks the disc is its own, and priority depends on who gets there first.

If you've three or more PETS, then you need a Mu-pet to make the most of them. • Circle No. 196



Yes, I want to see the Mu-pet show - please advise me on my nearest dealer.

Name

Address

KOBRA MICROSYSTEMS
14 The Broadway
West Ealing London W13 0SR
01-579 5845

KOBRA

PC9

October

- 1 **Northampton personal computer users' club discussion.** Venue: Northampton. Inaugural meeting which will include the exchange of software and ideas, discussions, demonstrations and talks. Contact: J R Jackson, Mereway Upper School, Mereway, Northampton NN4 9BU. Tel: Northampton 63616.
- 1-2 & 21-22 **Biztronic exhibition.** Venue: 1-2 Hotel Leofric, Coventry. 21-22 Forum Centre, Wythenshawe, Manchester. Features the latest in mini- and microcomputers, word-processing equipment, copiers and other electronic office equipment. Fee: free. Contact: Norman Green, 114 Kings Road, Harrogate, North Yorkshire, HG15 HP. Tel: 0423 55040.
- 1-3 **Assembly-language programming.** Venue: Bedford. Designed as a follow-up course to Introduction to micro-processing. On completion, the student will be able to write assembly language program modules and use the full capabilities of the TM990/101M microcomputer module and the TM990/302 software development module with dual audio/cassette interfaces and EPROM programming interface. Fee: £250 + VAT. Contact: Mike Hughes, Microprocessor Training Centre, Texas Instruments Ltd, Manton Lane, Bedford MK1 7PA. Tel: 0234 67466 Extn. 3718.
- 6 **An introduction to computers.** Venue: Wilmslow Guild. The course introduces in non-technical language the basic building blocks of microcomputers and will show how they may be combined to form computers such as the Pet, TRS-80 and Sorcerer which will be demonstrated. A major part of the course will also deal with the language Basic. Fee: £10. Contact: Julian Noble, Wilmslow Guild, 1 Bourne Street, Wilmslow. Tel: 0625 523903.
- 6-8 **Microprocessor workshop.** Venue: Manchester. A three-day introductory course for engineers with little or no knowledge of microprocessors. The course is based on the AIM-65 board and introduces all aspects of software development by practical programming sessions. Fee: £195 + VAT. Contact: Microsystems Consultants, Ltd, PO Box 65, Camberley, Surrey GU15 1QN. Tel: 0276 27417.
- 6-10 **Introduction to the design of microprocessor-based systems.** Venue: Cambridge. The course gives the basic techniques necessary for the design of microprocessor-based systems by lectures and hands-on practical design work. Designed for engineers with little or no microprocessor experience, programmers, project leaders and managers. Fee: £265 + VAT. Contact: Cambridge Microcomputers Ltd, Cambridge, Science Park, Milton Road, Cambridge, CB4 4BN. Tel: 0223 314666.
- 7 **6502 Programming — Machine-code programming on Pet.** Venue: Manchester University. Every Tuesday for 10 weeks. Aims to show how to program the 6502 and how the speed of searching, looping and data handling can be increased. Also includes examination of Pet memory, uncovering many locations and subroutines. The course would suit competent programmers in a high-level language and would be of interest to any Pet user who wishes to make more efficient use of his machine. Fee: £10. Contact: Enrolment Secretary, Department of Extra Mural Studies, The University, Manchester M13 9PL. Tel: 061 273 3333.
- 8 **An introduction to microcomputers for businessmen.** Venue: Manchester University. Intended to acquaint businessmen with the terminology of microcomputers, their disadvantages and uses. At the end of the course, participants should be able to assess what kind of system would be appropriate for their businesses. Fee: £20. Contact: Enrolment Secretary, Department of Extra
- 9 **Mural Studies, The University, Manchester M13 9PL.** Tel: 061 273 3333.
- 9 **Basic programming on Pets.** Venue: Manchester University. Offers to those who have little or no programming, of computer-operating experience a grounding in the writing of programs in Basic. Fee: £15. Contact: Enrolment Secretary, Department of Extra Mural Studies, The University, Manchester M13 9PL. Tel: 062 273 3333.
- 9-10 & 23-24 **Introduction to microprocessing.** Venue: Bedford. Introductory course using the TMS 9900 minimum system. Fee: £95 + VAT. Contact: Mike Hughes, Microprocessor Training Centre, Texas Instruments Ltd, Manton Lane, Bedford, MK1 7PA. Tel: 0234 67466.
- 14-16 **Advanced microprocessor design techniques.** Venue: London. Designed for engineers with a good understanding of microprocessor system design. Fee: £240 + VAT. Contact: Course Registrar, Ganymede Division, SIA Ltd, 23 Lower Belgrave Street, London SW1W 0NW. Tel: 01-730 8171.
- 20-21 **The impact of microtechnology.** Venue: Hitchin, Hertfordshire. Designed for senior data processing and management service executives. Covers the technology of microprocessors and their impact on corporate systems architecture, and the use of microcomputers in traditional and innovative applications. Fee: £120 + VAT. Contact: Keith London Associates, 6 St. Albans Road, Codicote, Hitchin, Hertfordshire. Tel: 0438 820309.
- 20-24 **Practical microprocessor course for beginners.** Venue: London. Designed for engineers from any disciplinary background who need experience in handling a microcomputer. No electronic experience is assumed. The course has a strong practical content and participants will work with development equipment to configure working systems. Fee: £400 + VAT. Contact: Course Registrar, Ganymede Division, SIA Ltd, 23 Lower Belgrave Street, London SW1W 0NW. Tel: 01-730 8171.
- 21 **Practical introduction to microcomputers.** Venue: Cambridge. Covers the basics of microprocessors and how to use them with hands-on-training using the SGS-Ates Nanocomputer. Fee: £55 + VAT — if you buy a Nanocomputer, the course is free. Contact: Cambridge Micro Computers Ltd, Cambridge Science Park, Milton Road, Cambridge CB4 4BN. Tel: 0223 314666.
- 22 **Microprocessors — management appraisal.** Venue: Worthing. Enables the manager to appreciate the impact of microprocessors on his business today, to assess their potential and to plan for their possible introduction into his organisation. Fee: £70 + VAT. Contact: Carole Jones, MSS Computer & Business Consultancy, 49 Chapel Road, Worthing, West Sussex, BN11 1EG. Tel: 0903 34755/6.
- 25 **National TRS-80 users' group workshop.** Venue: Oxford. Randolph Hotel. Fee: £8.15. Contact: Brian Pain, 40a High Street, Stony Stratford, Milton Keynes. Tel: (0908) 566660/564271.
- 27-30 **Basic programming and numerical methods.** Venue: North-east London Polytechnic. Designed for engineers wishing to update their knowledge on numerical methods. Computing facilities available, 1904s ICL mainframe computer, PDP-11 minicomputer, North Star, SWTP and Sharp microcomputer systems. Fee: £250. Contact: R E Bright, Short Course Organiser, School of Chemical and Systems Engineering, North-east London Polytechnic, Longbridge Road, Dagenham, Essex. Tel: 01-590 7722 Ext. 2060.
- 29 **Micro or minicomputer — selection criteria.** Venue: Brighton. Designed to enable management to appreciate the relative merits and demerits of micro- and minicomputer systems. Fee: £70 + VAT. Contact: Carole Jones, MSS Computer and Business Consultancy Ltd, MSS House, 49 Chapel Road, Worthing, West Sussex. BN11 1EG. Tel: 0903 34755/6. 

P1 RECORD MANAGEMENT SYSTEM

PET (min 16k, new ROM) database system, user defined records. Search/Sort on any field. Update randomly/serially. Save/Load files on tape or disk. Interrogation — interactive/batched. Documentation and detailed examples included L55 (inc. tape).

P2 CROSSNUMBER PUZZLES

Generates crossnumber puzzles (not interactive). Clues are arithmetic sums, at a selected level or revision upto that level. Solutions also generated L5. (PET or SWTP tape L1 extra)

G1 AIRCRAFT LANDING SIMULATION

Real time using PET graphics. Try your hand at landing an aircraft in varying visibility. PET tape L4.

G2 GRAVEYARD

Real time using PET graphics. Game for one player, object survival, requirements quick thinking and nimble fingers. PET tape L4.

(p & p FREE, SAE for more details)

EXCEL COMPUTER PROGRAMS

4 Empress Ave.,
Fulwood, Preston PR2 4JT

• Circle No. 197

NEW! NEW! NEW! NEW! NASCOMS 1 & 2 D/A NASBUS BOARD

two 8 bit converters, full scale outputs 2.5 - 5.0V.

from £69.50

INPUT/OUTPUT BOARD

up to 5 PIO devices

for more details SAE.

BING SYSTEMS, 8 Glen Rd,
Bingley, West Yorks, BD16 3ET.

• Circle No. 198

IBM GOLFBALL PRINTERS From £425 + VAT



Reconditioned printers with keyboard and RS232 interface:

Sales — Service — Supplies

AID Office Supplies
Brindivell Ltd.,
Frampton Cotterell
BRISTOL

Telephone: Winterbourne (0454) 774564

• Circle No. 199

NORTH LONDON HOBBY COMPUTER CLUB Notice of Annual General Meeting

The AGM will be held in the Students' Common Room at the Polytechnic of North London on Wednesday 24th. September, starting at 1930.

Nominations for the Committee must be in the hands of the Committee not less than ten days prior to the meeting. They must be signed by a proposer and seconder and accompanied by evidence that the nominee is willing to serve on the Committee.

Notice of two Extraordinary Motions for discussion:
1. That item 6 of the Constitution be amended to permit notice of any General Meeting to be given either by post or by advertisement in two nominated journals.

2. That item 13 of the Constitution be amended to permit the Committee to accept further nominations at the AGM if insufficient are to hand to fill the number of vacancies.

• Circle No. 200

Subroutines and the stack

The use of subroutines is a vital technique indispensable to any self-respecting programmer. David Peckett describes the subroutine facilities provided on the 6502 and Z-80 and looks at something fundamental to the use of machine-code subroutines — the stack.

IN PREVIOUS articles, I have given examples of program segments which have specific functions — read and store data, perform multiplication, etc. Yet they are not practical programs.

Real programs are far more complex, but can be reduced usually to a set of simple functions such as read and store data, multiply and so on. Often, a given function is used by several different parts of a program and may also be needed in other programs. It is because of that need to perform the same, or essentially the same, task in several places that subroutines were invented.

If you have ever programmed in a high-level language such as Basic, you will al-

worry about how many bytes there are in each instruction.

The main program then runs to address "efgh", where there is another call to "wxyz". Once more, the subroutine runs until it has finished, and hands back control to the main program, this time at "efgh + 1". Effectively, the subroutine's code is slotted into two places in the main program, although it is written down only once.

You can see that to implement a subroutine, two things must be available:

- A mechanism to jump to the subroutine, while keeping a finger on the point in the main program from which the call was made.
- A facility for jumping back to the right place in the main program when the subroutine is finished.

You could satisfy those requirements with a careful use of jumps, but that would be very untidy. A much better approach is to use special instructions. In Basic,

```
270 GOSUB 2500
```

calls the subroutine which starts at line 2500, while saving the line number of the next instruction (280?). The last instruction in the subroutine is:

```
2590 RETURN
```

That recovers the number of the next line automatically in the calling program and performs a "GOTO".

A micro has operations which are equivalent to Basic "GOSUB" and "RETURN". In the case of the 6502, the

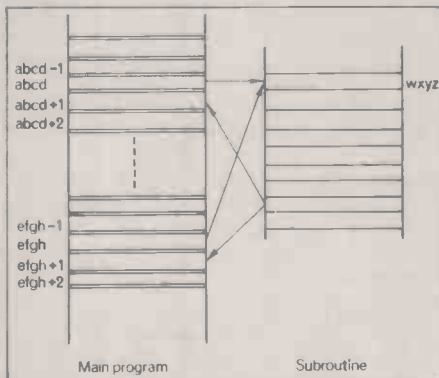

Figure 1. Subroutine call and return.

ready have met the idea of subroutines. For those brave souls who are tackling this series without any programming experience, what is a subroutine?

A subroutine is a section of a program which may be called from anywhere in a main program. The subroutine normally does a specific, often common, task, such as read and store data, multiply, etc. A subroutine call is similar to a jump, in that the program counter (PC) is set to the address of the start of the routine.

However, at the end of the subroutine, the program jumps back to the instruction immediately after the address from which it was called.

Figure 1 shows that diagrammatically. The main program runs normally until it reaches address "abcd", where there is an instruction calling the subroutine which starts at "wxyz". The subroutine then runs until it is finished, at which point it returns control to the main program at address "abcd + 1". That is the next instruction after the "call" — let us not

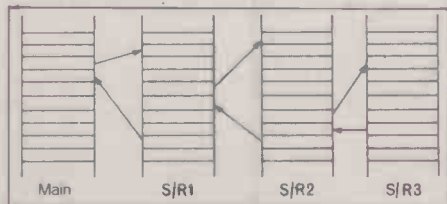

Figure 2. Nested subroutines.

calling instruction is "JSR" (Jump to SubRoutine), and the subroutine ends with an "RTS" (ReTurn from Subroutine). The corresponding Z-80 instructions are "CALL" and "RET".

The return address must obviously be stored somewhere. In early micros, it was saved in a special register inside the chip, but it is now normal to use a specially-allocated area, called the stack in main memory.

Machine code

Invariably, the return address is stored in a way that allows us to nest sub-routines, i.e., one can call another, which can call another, *ad infinitum* — figure 2.

We have already seen one common use of subroutines — the provision of a single block of code which can be called from many different places in a program. The alternative would be to place identical code in each place it was needed. The latter would waste a good deal of space and be very error-prone, since you would have to re-enter the code every time.

Another common way of using subroutines is from a program library. As we have seen, the same functions can be needed by many programs. By writing a

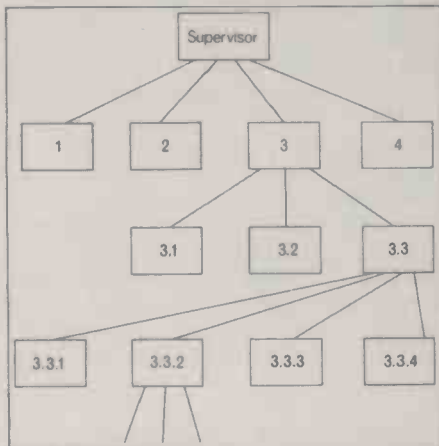

Figure 3. Top-down structured program.

general subroutine once and saving it when it has been debugged, you can use it as often as you want as a standard function.

A third major use of subroutines, and one that is related to the first two, is the programming technique, top-down programming. It is a powerful tool which can discipline and speed software development.

It relies on each major program function being written as a subroutine, calling lesser subroutines for smaller tasks, which in turn call even lesser subroutines — figure 3. Control passes only up and down the program and never sideways.

By writing in that way, you can develop the program one subroutine at a time, starting from the top. At each stage, you represent all the unwritten routines called by dummies. You have to debug only one subroutine at a time, and, by limiting your debugging in that way, you can find problems very quickly. Pascal is a good example of a high-level language designed to be used in top-down programming, although you can use the technique with any language.

Some assemblers provide a macro facility. At first glance, it looks very like a subroutine, but it is, in fact, totally different.

A macro is a block of assembly code which has been given a label. Every time the code is needed in the program, the

label is used instead. Effectively, the macro facility allows you to define pseudo-operations to suit the specific needs of your program.

For instance, you may be writing a 6502 program which often needs to swap the contents of X and Y. You could write a macro to do this:

```

MACRO SWAPXY
STX DUMMY ;SAVE X
TYA ;MOVE
TAX ;Y TO X
LDY DUMMY ;SET Y

```

ENDM

Thereafter, whenever you needed to interchange X and Y, you could use the single command "SWAPXY". Beware: I have used an imaginary macro construction language here — check your own assembler.

Although with both macros and subroutines you write the code only once, there is a fundamental difference between the two. If you are using a subroutine, the assembly language program mirrors exactly what will appear in the object code — the subroutine is only there once. A macro, on the other hand, is a set of instructions to the assembler. It effectively says: "When you assemble this program, every time that you see the macro label, insert this block of code". The code associated with a macro thus appears every time the macro is used.

The result is that a program using macros will run faster than a program using equivalent subroutines because no time will be lost in the call and return operations. On the other hand, it will be physically longer than the subroutine-based program. Also, it may be easier to debug and modify the program which uses subroutines.

At last we reach that mysterious object, the stack. In fact it is not very mysterious at all. The stack is simply an area in the main memory the micro can write to and read from very quickly.

The stack is organised as a last-in, first-out (LIFO) store. If you read a byte from the stack, you obtain the last one which went into it, and if you read "n" bytes off the stack, you have the last "n" which went on, in reverse order.

A stack is normally organised so that it is loaded from the high addresses down. Thus, if the stack lies between 0100₁₆ and 01FF₁₆, the first byte on to it will go to address 01FF, the second to 01FE, and so on — figure 4.

The micro accesses to the stack by a special register, the stack pointer (SP), which keeps a record of where in the stack the micro is working. There is a basic difference between the SP logic of the 6502 and the Z-80. The 6502 SP points to the next vacant address in the stack; for example, if the last byte went to address 012E₁₆, the SP will contain 012D.

The Z-80 SP, on the other hand, points to the last byte which went into the stack; in the last example, the SP would continue

(continued on next page)



Superboard-, UK101- and TRS-80-compatible

COLOUR YOUR NASCOM!

DAZZLING COLOUR GRAPHICS FOR NASCOM 1 & 2

Genuine bit-addressable "pixel" system for straight-forward programming of pictorial or mathematical functions.

8 Colour display plus 8 colour independent background facility. Full documentation with FREE SOFTWARE: powerful sub-routines for vector generation, demonstration program for animated effects. All runs in Nascom 1 without expansion. Complete with UHF Colour Modulator for operation with normal colour TV set. Superior design allows connection to most other micro-processor systems — send us diagrams etc of your b & w video circuitry for free advice. Don't be fooled by the price: this is a top quality product which will transform your computer.

NOW AVAILABLE FOR **£45 + VAT**
LIMITED PERIOD AT

WILLIAM STUART SYSTEMS Ltd
Dower House, Billericay Road, Herongate, Brentwood, Essex CM13 3SD. Telephone: Brentwood (0277) 810244

• Circle No. 201

OHIO SCIENTIFIC NEWS FLASH

FULL RANGE OF SUPERBOARDS TO C3's

Best prices, best backup, best service from an Ohio Scientific factory appointed dealer/importer

Ringing us for latest prices on boards, accessories, expansion, software etc.

50Hz Superboard prices start

From **£159.95 + VAT**
C.T.S., 1 High Calderbrook
Littleborough
Lancs OL15 9NL
Tel: Littleborough (0706) 79332
ANYTIME

• Circle No. 202

TRS-80 SOFTWARE

Well-documented, load-anywhere, machine-language utilities for Level 2 or 3, 4K and up.

| | £ |
|----------------------|-------|
| ZBUG monitor | 11.95 |
| TSAVE tape generator | 4.95 |
| RENUM renumber Basic | 5.95 |
| XREF cross-reference | 5.95 |
| SDUMP symbolic dump | 2.95 |
| DLOAD dynamic load | 4.95 |

SOUTHERN SOFTWARE
PO Box 39, Eastleigh, Hants. SO55W0

• Circle No. 203



| Operation | 6502 | | | Z-80 | | |
|------------------------|-------|-------|-----------------------|-----------|---------------------|-----------------------|
| | Mnem. | Flags | Effect | Mnem. | Flags | Effect |
| Call Subroutine | JSR a | None | PC to Stack PC = a | CALL a | None | PC to Stack PC = a |
| Return from Subroutine | RTS | None | PC from Stack | RET | None | PC from Stack |
| A to Stack | PHA | None | A to Stack | — | — | — |
| PSW to Stack | PHP | None | PSW to Stack | — | — | — |
| A from Stack | PLA | N,Z | A from Stack | — | — | — |
| PSW from Stack | PLP | All | PSW from Stack | — | — | — |
| RP to Stack | — | — | — | PUSH rp | None | RP to Stack |
| RP from Stack | — | — | — | PULL rp | All if RP = "AF" | RP from Stack |
| Transfer SP to X | TSX | N,Z | X = SP | — | — | — |
| Transfer X to SP | TXS | None | SP = X | — | — | — |
| Load SP | — | — | — | LD SP,o | None | SP = d/(a) |
| Save SP | — | — | — | LD (a),SP | None | (a) = SP |
| Increment SP | — | — | — | INC SP | None | SP = SP + 1 |
| Decrement SP | — | — | — | DEC SP | None | SP = SP - 1 |
| Add SP to HL | — | — | — | ADD HL,SP | H,N,C | HL = HL + SP N=0 |
| Move HL to SP | — | — | — | LD SP,HL | None | SP = HL |

Notes: "a" = Address — defined by the program
 "d" = Data — defined by the program
 "o" = Operand — can be an address or data
 "rp" = Z-80 Register Pair
 "/" = Either/or

Brackets: "Data at the address defined between the brackets".

All the 6502 instructions use implied addressing, apart from "JSR" which uses direct addressing.

Table 1. This month's instructions.

moving data between the stack and a single register, you waste time having to transfer two bytes. Conceivably, the stack could become too large as well.

To be honest, that is not a major weakness. You must remember, however, that every time that you pull data into A from the Z-80 stack, you may be re-setting the flags. That could result in complications. It also suggests a way of setting the flags to a given pattern if this is every necessary:

```
LD C,FLAGS ;SET PATTERN INC
PUSH BC ;TRANSFER C TO F
POP AF ;VIA THE STACK
```

Obviously, you could preserve A by a "LD B,A" at the start.

The Z-80 stores RPs on the stack in its usual double-byte way — the low byte goes in the lower address. Because the stack grows from the top down, the high byte is PUSHed on first, and POPped-off last. In "AF", F is treated as the low byte.

That technique of temporarily storing data on the stack looks very useful. There is a complication: if you push data on to the stack in the middle of a subroutine, the SP no longer points to the return address — that makes it difficult to leave the subroutine.

What we need are ways to save the SP and to manipulate it. Both micros can do that; not surprisingly, the 6502 is more limited in its capabilities than the Z-80. Table 1 includes the instructions which affect the SP.

In 6502 SP manipulation, all the 6502 can do is move the SP to X ("TSX") and move whatever is in X to the SP via "TXS". Of course, once the data is in X, we can do much more with it.

With Z-80 SP manipulation, the Z-80 can treat the SP, in many ways, as just one more RP. Thus, it can load it from

memory via "LD SP, (addr)" or immediately, "LD SP,data". The SP can also be incremented or decremented via "INC SP" and "DEC SP", and stored in memory by using "LD (addr),SP".

If we need to preserve the value of SP, we might want to keep it in another RP. There is not an instruction to do that

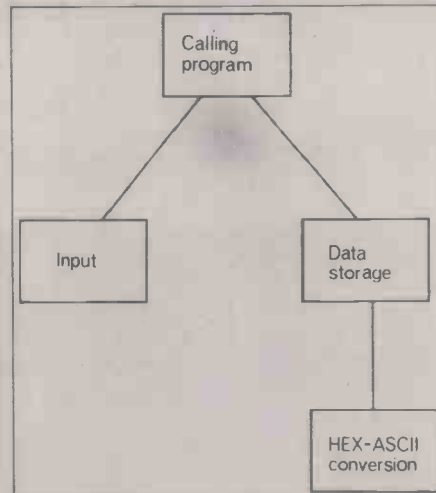

Figure 7. Program structure.

directly, but we can add the contents of SP to HL ("ADD HL,SP"). Therefore:

```
LD HL,O
ADD HL,SP
```

will load HL with SP. Later, if necessary, we can put HL straight into SP via "LD SP,HL".

Normally, when you switch on a micro, the SP is not set to the correct value automatically. Any computer system will have a re-set procedure, which is generally a short length of code to put the system on the air. One of its functions will be to set

(continued on next page)

DISKWISE



THE Apple Agents in Devon & Cornwall Present

Quality Software direct or from your local Apple Dealer.

HOTELPLAN — Hotel Management system inc. booking & Guest Billing. £475. TV RENTAL MANAGEMENT £395.

TRADE ENQUIRIES WELCOME

25 Fore St., Callington, Cornwall
Tel. 05793 3780



• Circle No. 208

6800

Software at reasonable prices ... ones you can afford!!!

We can offer refurbished systems or SS50 boards with a warranty to boot and at vastly reduced prices. This could be your chance to enhance your system, or to cash in on your surplus equipment.

Interested? then contact: —
COMPUSENSE LTD.
P.O. Box 169

London N13 4HT tel. 01-882 0681
P.S. We have a home for old pets or rotten apples too!!

• Circle No. 209

LIGHT PEN FOR THE TRS 80

MICRODATA

THE ULTIMATE LOW COST PERIPHERAL FOR THE LEVEL TWO TRS 80 THE PHOTOPoint PACKAGE INCLUDES:

A FULLY ASSEMBLED LIGHT PEN
 A CASSETTE OF FOUR PROGRAMS (Including Backgammon)
 INSTRUCTION ON WRITING YOUR OWN PROGRAMS
 A 9V BATTERY

JUST PLUG IN AND GO!
 THE LIGHT PEN CONNECTS EASILY TO YOUR TRS 80 VIA THE CASSETTE RECORDER AND REQUIRES ABSOLUTELY NO MODIFICATIONS TO YOUR SYSTEM.

ONLY £16.99 + 30p P&P
 WE CAN ALSO SUPPLY A RANGE OF ADDITIONAL SOFTWARE FOR YOUR LIGHTPEN AT PRICES FROM £2 PER PROGRAM ON CASSETTE.

CSL MICRODATA
 4, GREENBARN WAY,
 BLACKROD, LANCASHIRE BL6 5TA.

• Circle No. 210

Required:

Workshop engineer familiar with repairing Micro Processor controlled system. Experience welcome, but not necessary. Please write to:

Video Games Sales
 24, Langroyd Road
 LONDON SW17

• Circle No. 211



**OVERPRICED COMPUTERS
INADEQUATE PERSONAL MICROS?**

Modata supply Dealers and OEMs with Digital Microsystems competitively priced Single and Multi-User computers which include Reliable Floppy and Hard Disk storage.

ie. DSC-2: Z80 at 4MHz + 64Kb +
2 x SSD8 Floppies for 1Mb + CP/M
£3525 E.U.

**WHY NOT FINDOUT MORE?
0892 41555**

Modata Ltd. 30 St. Johns Road,
Tunbridge Wells, Kent TN4 9NT

• Circle No. 212

**E-A
Electronic Aids
Tewkesbury**

Our long list of commercial and educational software for CBM/PET includes:
Manufacturer a complex accountancy programme which handles orders and invoices for a small factory at very modest cost £300
Data & Invoice keeps up-to-date records of customers' orders on cassette or disk and issues invoices £150
Function plots graphs of mathematical functions on the screen £15
Pictures allows you to draw pictures or maps on the screen and to save these on file until they are needed £20
 Whether you need a commercial, industrial or scientific programme, for a very competitive service write to

ELECTRONIC AIDS (TEWKESBURY)
Mythe Crest, The Mythe, Tewkesbury,
Glos. GL20 6EB
or phone (0386) 831020

• Circle No. 213

**SHARP
PC 1211
POCKET COMPUTER**

ONLY
£85
+ VAT

This amazingly powerful machine is now within your pocket.

NOW AVAILABLE

Price includes: Applications Manual (over 80 programs), Beginners "BASIC" Textbook and Instructions Manual.
CE-121 Cassette Interface £11.50 + VAT

Make P.O.'s/Cheques payable to:—
S&J COMPUTER SALES
25, LYNTON CRESCENT,
GANTS HILL, ILFORD, ESSEX.

Allow 28 days for delivery.
FULL Service Guaranteed

• Circle No. 214

(continued from previous page)

the SP to the correct starting value.

In the case of the 6502, the stack will almost certainly start at the top of page-1, i.e., at 01FF₁₆. Since the SP must be manipulated via X, the code will have the form:

```
LDX # 8FF ;TOP OF STACK
TXS ;INITIALISE THE SP
```

A Z-80 stack can be anywhere in memory except at the very bottom. Sometimes, a Z-80 system may have more than one stack. Initialisation is easy, though:

```
LD SP,data ;INITIALISE STACK
```

If you are writing real programs, you must remember to set-up the stack — I shall take it for granted from now on.

Let us now look at some typical sub-routines for input/output. Suppose data is input to a micro in normal eight-bit bytes. However, we have to split each byte into its two nybbles and convert each nybble into the ASCII code representing its Hex value. We will then store the characters in memory, starting at "DATA", with the first character at the lowest address. Thus, if "n" bytes enter, the characters will lie finally at addresses between "DATA" and ("DATA" + 2n - 1) — figure 6.

The data in each byte is packed so that the high nybble represents the first character. The system is to read each byte from address "WORD"; each byte will be ready when the MSB of "STATUS" is set to "1". A byte of value "00" shows the

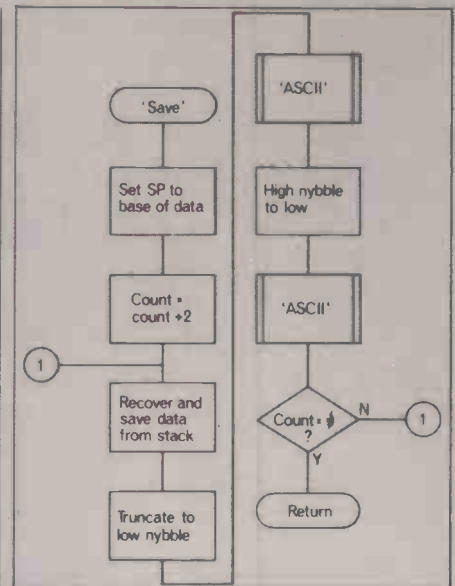

Figure 9. Save subroutine.

end of the data input — it should not be saved.

To make life interesting, let us assume that the data will enter so fast that there will be no time to split it into ASCII characters in real time. We save it in the stack and manipulate it when it has stopped arriving. Assume also that there will be no more than about, say, 100 bytes in the input string.

Finally, let us put "WORD" and "STATUS" at adjacent address, with

Table 2. Stack during 6502 input routines.

| | Event | X | Y | SP | BASE | Stack |
|----|--|----|-------|----|------|--|
| 1. | At Start | — | — | FF | — | IFF IFE IFD IFC IFB IFA |
| 2. | Just after entry to "INPUT" | FD | 0 | FD | — | RETURN ADDRESS 1 IFF IFE IFD IFC IFB IFA |
| 3. | After recognising termination byte | FD | 2 | FB | — | RETURN ADDRESS 1 DATA 1 IFF IFE IFD IFC IFB IFA |
| 4. | Immediately before return from "INPUT" | FD | 2 | FD | FB | DATA 2 IFF IFE IFD IFC IFB IFA |
| 5. | Just after entry to "SAVE" | 4 | 2 | FB | FB | RETURN ADDRESS 2 DATA 1 DATA 2 IFF IFE IFD IFC IFB IFA |
| 6. | After first entry to "ASCII" | 4 | DATA2 | FA | FB | RETURN ADDRESS 2 DATA 1 RETURN ADDRESS 3 IFF IFE IFD IFC IFB IFA |
| 7. | Before return from final "ASCII" | 0 | DATA1 | FB | FB | RETURN ADDRESS 2 RETURN ADDRESS 4 IFF IFE IFD IFC IFB IFA |
| 8. | Before return from "SAVE" | 0 | DATA1 | FD | FB | RETURN ADDRESS 3 IFF IFE IFD IFC IFB IFA |



"STATUS" having the lower address. That is not as unlikely as it may sound.

To make it easy to develop the software, we shall use subroutines, one to input the data, and one to sort it afterwards. For each byte of data, we need two Hex-to-ASCII conversions and saves. It seems reasonable to make that function a subroutine, also. The end result will be a program structured as in figure 7.

Figures 8-10 give flowcharts for the three subroutines. As you see, the programming task appears simple because we only have to deal with one subroutine at a time.

None of the subroutines is particularly complex, but we must be very careful with the SP. For instance, when we enter "INPUT", the SP points to the return address. However, by the time that we have stored all the input data on the stack, the SP will point to the top of the data.

It is, therefore, important to save the SP as soon as we enter the routine. At the end we will restore the SP to point to the return address. Obviously, before we can do this, we have to record the top-of-the-data SP so that the "SAVE" routine will know where to find the data.

● **Input.** Initially, the SP is stored in X, and Y is zeroed to keep track of the number of bytes input.

The actual input routine is very simple — it waits for bit 7 of "STATUS" to be set, reads "WORD" and dumps it in the stack. The only oddity is the use of a "BNZ" to return to the start of the input loop each time. Strictly, we need an unconditional jump here, but since the "BNZ" always sees a non-zero Y, it acts as such a jump.

Finally, we have to tidy things by shuffling the SPs. The original one is dumped in A while the top-of-data one is passed, through X, to a store called "BASE". The return SP is then put back, via X, and the subroutine exits properly.

● **Save.** This subroutine starts with another SP shuffle. Assuming that the calling program has not fiddled with the stack, and that is up to you, the return address exactly overwrites the one remaining from "INPUT". We do not need to preserve deliberately this SP value, but we must re-set the SP to its "top-of-data" figure from "BASE".

If we read in originally "n" bytes, we will eventually store "2n" ASCII characters. We put, therefore, "n" into A from Y, double it with a shift, and pass it to X to use as an index and counter.

A byte is pulled off the stack, they are in reverse order, into A, and copied into Y. In figure 6, you see that the last nybble of the last byte will finish at the highest address in memory. Hence, as we pull each byte off the stack, we process its low nybble first, and store characters from ("DATA" + 2n - 1) downwards.

We obtain the low nybble of each byte by a simple truncation. "ASCII" then converts it to a character, stores it, and

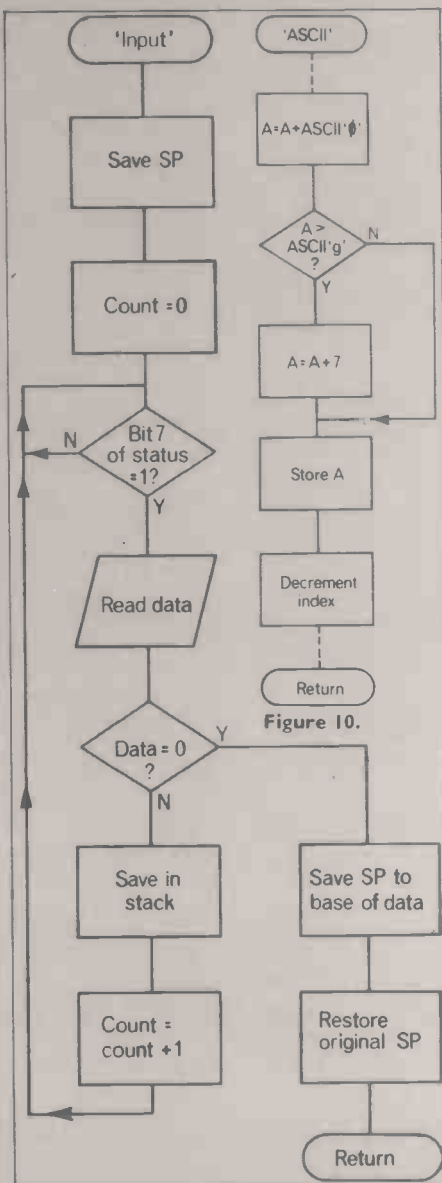

Figure 8. Input subroutine.

decrements the index register to point to the next storage slot.

We complete the processing of a byte by recovering it to A from Y. The high nybble is moved to the low nybble, and the four MSBs set to 0, with four logical right shifts. "ASCII" does its stuff again to save the character.

After each byte has been processed, X is checked for zero to see whether we have finished. The test relies on the Z flag being passed back unchanged from "ASCII".

When the routine is finished, the SP points to the return address automatically, since we have pulled all the data off the stack — table 2 — we just do a simple return.

● **ASCII.** When we call "ASCII", where does the return address go? The high byte overwrites the data we have just pulled off, and the low byte is in the slot below that — table 2.

If you look at an ASCII chart, e.g., the one in part two of the series, you can see the relationship between Hex

(continued on next page)

WORD-PROCESSING

written by C.B.C. for

APPLE & ITT 2020

END OF YEAR SALES

Use your own Micro and Printer and enjoy features found on WP systems costing £000's more! Not to be confused with simple text editing.

HUNDREDS SOLD IN THE 1st MONTH
Upper/lower case printing, full editing, format selection & change, save/recall of text, margin and R.H. justification, block insertion, mailshots etc. etc. A professional Program!

Mk 2 version £15 + VAT. incl. P&P
Your order plus Cheque, P.O. or Access/Barclay number to:

MILDMAY ELECTRONICS LTD.
200 Moulsham St., Chelmsford, Essex
Dealer enq. invited, other prog. & aids avail.

• Circle No. 215

PETER SCOTT FOR APPLE

SHARP MZ 80K • PC1 211 TEXAS SALES & SERVICE

Computer books, stationery, floppy discs, tapes etc.

Ring or call and discuss your requirements

PETER SCOTT (EXETER) LTD.,
76-78 SOUTH STREET
EXETER
Exeter 73309/56633

• Circle No. 216

THE SOFTWARE WORKSHOP

| | |
|---|------------------------|
| PAYROLL MASTER | |
| THE MOST VERSATILE PAYROLL SYSTEM ON THE MARKET. | £200.00 |
| SOFTWARE INSURANCE FOR THE ABOVE | £70.00 |
| APPLE DOC DOCUMENTS YOUR PROGRAMS FOR YOU | £24.95 |
| DISK UTILITY FILLS IN THE GAPS OF THE APPLE/ITT DOS | £20.00 |
| 70 SUSSEX ROAD, SOUTHPORT, MERSEYSIDE RP9 0SP | Tel: 0704 43038 |
| | ALL PRICES EXCLUDE VAT |

• Circle No. 217

EPROMPT ERASER



- CLEARS UP TO 32 CHIPS IN 30 MINS ON 200-250V A.C.
 - CONTINUOUS 253.7NM BEAM. SAFE & SIMPLE. GUARANTEED
 - £39 C.W.O. £40 C.O.D. • P&P+VAT INCLUSIVE !
- TRADE ENQUIRIES INVITED FOR SUBSTANTIAL DISCOUNTS
ALL ORDERS AND ENQUIRIES POST-FREE TO:

TEX MICROSYSTEMS LTD.
FREEPOST, ST. ALBANS, HERTS. AL1 1BR
TRING 4797/ST. ALBANS 64077 ANYTIME

• Circle No. 218

SWTP & GIMIX

6809 Hardware and Software
32-768K RAM, 340K-16Mb Disks
Multi-user BASIC, PILOT,
PASCAL, FORTRAN, Statistical
and Control Software. A-D, D-A
converters.

Research Resources Ltd
40 Stonehills
Welwyn Garden City,
Herts
(07073) 26633

• Circle No. 219

apple II in sussex

oval computer systems

elm park, ferring, worthing, west sussex.
tel:0903-44831

• Circle No. 220

PLUG IN RAM CARDS — SUIT ZX-80

Fully decoded ram cards, plugs directly into socket
at rear of ZX-80. Just 1K extra gives up to 5 times the
program area. The card will take up to 3K and has
sockets to take the ram chips. FULLY INCLUSIVE
PRICES.

1K ... £20 2K ... £30 3K ... £40

Send order to
QUICKSILVA
56 Bedford Place, Southampton,
Hants.
Or S.A.E. for further details

• Circle No. 221

APPLE— SOFTWARE

POS-Retail/Trade counter point-
of-system PPE-Single level Piece
Parts Explosion ideal for any
manufacturing process.
PHARM-STOCK-Stock Control
& Label printing package for use
in Retail pharmacy.

Further information & prices avail-
able on request from:—

Nicomtech Limited
212 St Stephens Road
Saltash, Cornwall PL12 4NI
Tele: Saltash (07555) 2066

• Circle No. 222

(continued from previous page)

and ASCII. The important point is the seven-character gap between "9" and "A".

"ASCII" first sets the high nybble from zero to 3₁₆, and tests to see whether the end result is greater than ASCII "9". If it is, another seven must be added. The subroutine uses a "CMP#83A" for the test, and monitors the carry.

The second addition allows for that by only adding six — the carry makes the total addition of seven.

Finally, the now-formed ASCII character is saved in memory via an indexed "STA" — why is the indexing base ("DATA"—1) — and X is decremented.

The Z-80 subroutines follow much the same pattern as those for the 6502, but, of course, use the Z-80 characteristics. In particular, they allow us to do everything within the chip's internal registers. The contents of table 2 are relevant to the Z-80 subroutines, although the details are, naturally, different.

• **Input.** That starts by saving the SP in DE, and initialising C to act as a counter. The zero in C is copied into A.

Now you can see why we made "STATUS" and "WORD" adjacent. We load them both into HL at once, which speeds the program. At first, of course, we are concerned only with L, which contains "STATUS", but when a word is ready, it is in H automatically.

The data is tested for zero against A — that is why we zeroed A — and, if non-zero, saved in the stack. Each time we do that, we also clutter the stack with L.

At the end of the routine, we collect the "top-of-data" SP in HL. Swapping DE and HL saves the final SP in DE, and presents the return SP value to HL for easy transfer.

• **SAVE.** First we zero B and re-set the SP to the value we had saved in DE. Having done that, 16-bit addition is used to make HL a pointer to the highest address of the block of memory where the data is to be saved. Before we start on the storage loop, B is set to "n" so that we can use a "DJNZ" to control the iterations.

To manipulate the data, pairs of bytes are popped into AF. This process loads A with the data originally read into H, i.e., "WORD", while F is set to the value which was in "STATUS".

The two nybbles are separated exactly as in the 6502 program, and processed via two calls to "ASCII". At the end of each iteration of the storage loop, we use B as a count. In that respect, the subroutine is functionally different from the 6502 "SAVE" which uses X as both index and counter.

• **"ASCII".** This subroutine is very similar to that for the 6502. The only significant difference is that the Z-80 shows no borrow by setting the carry flag to zero, so that we have to add seven for the 9-A offset.

```

;6502 DATA HANDLING SUBROUTINES
;
; INPUT SUBROUTINE
; THIS STORES INCOMING BYTES IN THE STACK.
; THE NUMBER OF BYTES ARE RETURNED IN Y.
; AND "BASE" HOLDS THE SP TO THE DATA STORED
; IN THE STACK
;
INPUT   TSX          ;SAVE STACK
        LDY         #0      ;ZERO COUNT
WAIT    LDA         STATUS
        BPL        WAIT    ;BIT 7 SET?
        LDA         WORD   ;YES, READ DATA
        BEQ        END     ;TERMINATOR?
        PHA         ;NO, SAVE DATA
        LDY         ;INCREMENT COUNT
        BNZ        WAIT    ;GO FOR NEXT BYTE
; INPUT OVER - TIDY UP
END     TXA          ;MAKE ROOM IN X
        TSX          ;FINAL VALUE OF SP
        JTX        BASE   ;SAVE SP
        TAX         ;RESTORE
        TXS        ;ORIGINAL SP.
        RTS         ;END OF ROUTINE
;
; SUBROUTINE TO SAVE DATA
; THE SP TO THE DATA IS PASSED IN "BASE"
;
SAVE    LDY         BASE
        TKS        ;RESET SP
        TYA        ;TO BASE OF DATA.
        ASL        ;DOUBLE COUNT FOR
        TAX        ;STORAGE AND INDEX.
        AND        #0FFH ;SET INDEX
NEXTBYT PLA        ;RECOVER BYTE
        TAY        ;SAVE BYTE
        AND        #0FFH ;TRUNCATE TO LOW NYBBLE
        JSR        ASCII  ;CONVERT TO ASCII
        TYA        ;RECOVER BYTE
        LSR        A      ;PUT HIGH
        LSR        A      ;NYBBLE TO LOWER;
        LSR        A      ;SET HIGH BITS
        LSR        A      ;TO ZERO.
        JSR        ASCII  ;CONVERT TO ASCII
        BNE        NEXTBYT ;FINISHED?
        RTS         ;YES, RETURN
;
; SUBROUTINE TO CONVERT DATA TO ASCII AND SAVE IT
; THE NYBBLE TO BE PROCESSED IS PASSED IN A
;
ASCII   ORA         #80H   ;ADD ASCII PREFIX
        CMP        #9FAH  ;TEST TO SEE
        BCC        NUMBER ;IF A-F
; A IS NOW ASCII CHARACTER
        ADD        #1, X  ;ADD ALPHA OFFSET (6-CY)
        STA        DATA-1,X ;SAVE CHARACTER
        DEX        ;POINT TO NEXT STORE
        RTS         ;DOESN'T CHANGE Z FLAG
;
; END OF SUBROUTINES

```

Figure 11.

Figure 12.

```

; Z80 DATA HANDLING SUBROUTINES
;
; INPUT SUBROUTINE
; INCOMING BYTES ARE STORED IN THE STACK.
; THE NUMBER OF BYTES IS RETURNED IN C, AND
; DE CONTAINS THE SP TO THE BASE OF THE DATA
;
INPUT   LD          HL,0    ;SAVE
        ADD        HL,SP   ;SP
        EX        DE,HL   ;IN DE.
        LD        C,0     ;ZERO COUNT
WAIT    LD          HL,(STATUS) ;L=STATUS, H=WORD
        BIT        7,L     ;MSB=1?
        JF        N2,WAIT ;
        CP        N       ;TERMINATOR?
        JF        Z,END   ;
        PUSH     HL       ;NO, SAVE DATA
        INC     C         ;INCREMENT COUNT
        JP        OVER    ;GO FOR NEXT BYTE
; INPUT OVER - TIDY UP
END     LD          HL,0    ;SAVE FINAL
        ADD        HL,SP   ;SP VALUE
        EX        DE,HL   ;L=DE
        LD        SP,HL   ;RESTORE ORIG SP
        RET         ;END OF ROUTINE
;
; SUBROUTINE TO SAVE DATA
; THE NECESSARY PARAMETERS ARE IN THE MICRO ALREADY
;
SAVE    LD          B,0    ;NEED THIS LATER
        EX        DE,HL   ;DE=SP
        LD        SP,HL   ;SP TO BASE OF DATA
        LD        HL,DATA-1 ; POINTER
        ADD        HL,BC   ;FOR
        ADD        HL,BC   ;DATA STORAGE
        LD        B,C     ;COUNTER
NEXTBYT PUP        AF     ;RECOVER BYTE
        LD        C,A     ;SAVE
        AND        #0FFH  ;TRUNCATE TO LOW NYBBLE
        CALL     ASCII    ;CONVERT AND SAVE
        LD        A,C     ;RECOVER BYTE
        SRL        A      ;SHIFT
        SRL        A      ;TO
        SRL        A      ;LOW
        SRL        A      ;NYBBLE
        CALL     ASCII    ;CONVERT AND SAVE
        DJNZ    NEXTBYT  ;FINISHED?
        RET         ;YES
;
; SUBROUTINE TO CONVERT DATA TO ASCII AND SAVE IT.
; THE NYBBLE IS PASSED IN A. HL POINTS TO STORAGE.
;
ASCII   OR          #80H   ;ADD ASCII PREFIX
        CP        #9FAH  ;TEST FOR
        JF        C,NUMBER ;A-F
        ADD        #1, A  ;
; A IS NOW ASCII CHARACTER
        LD        HL,(HL),A ;SAVE CHARACTER
        DEC     HL        ;POINT TO NEXT SPACE
        RET
;
; END OF SUBROUTINES

```

BUYERS' GUIDE

The Buyers' Guide is a summary of low-cost computers available in this country. It appears every third month; we add new computers and amend existing information, as required, to keep it up-to-date. Systems are listed by manufacturer.

Microcomputers

ACORN COMPUTERS

Systems 1.2.3.: 6502-based, 1-8K RAM, COS or DOS, Hex or full keyboard, TV interface, Acorn bus. Personal or scientific use. Reviewed September 1979. *From £65 for System 1 kit; £285 for System 2 kit; £670 for System 3 kit*

Atom: 6502, 2-12K RAM, up to 40K external memory, full keyboard, Basic in ROM, high-resolution graphics, cassette and TV interface, parallel port, I/O lines. Should eventually be able to link into a ring. Acorn Computers Ltd, 4a Market Hill, Cambridge CB2 3NJ (0223) 312772. *From £130*

ALAN PEARMAN LTD

Maple: Z-80A, 16-64K RAM, S-100 bus, CP/M, 8in. discs, RS232 serial and parallel. Sold mainly as Micro-APL system. Alan Pearman Ltd, Maple House, Mortlake Crescent, Chester CH3 5UR. (0244) 46024. *From £1,510*

ALPHA MICRO

AM-1010, AM-1051: WD-16, 64K-16MB RAM, S-100, four 8in. up to 90MB hard discs, RS232 up to 20 ports. Alpha Micro, 13 Brunswick Place, London N1 6ED. (01) 250 1616. *From £7,500*

APPLE COMPUTERS

Apple II Plus: 6502, 16-48K RAM, 8K ROM, colour graphics, 5¼in. discs, general use. Own bus. Reviewed October 1979. *From £695*

Apple III: 6502A with supporting chips, giving it a superset of 6502 instruction set. 96-128K RAM, colour graphics, integral 5¼in., RS232, four 50-pin expansion slots. Microsense, Finway House, Hemel Hempstead, Hertfordshire HP2 7PS. (0442) 48151. *P.O.A.*



Verbatim



TOP QUALITY FLOPPIES

| Single Side Single Density Diskettes | Unit Price | All Inclusive Price per Box |
|--------------------------------------|------------|-----------------------------|
| 8" | £2.42 | £29.55 |
| 5¼" | £1.83 | £22.77 |

Sold in Boxes of 10

Always Quote Your Machine Type When Ordering

- Many other Types Available
- We Can Quote for Your Machine
- Quantity Discount For 50 +

Please Give Us A Ring

GRAM
BUSINESS SYSTEMS

48 HEDLEY STREET,
MAIDSTONE, KENT ME14 5AD
MAIL ORDER ONLY

• Circle No. 223

COMPUT-A-CROP

EX-DEMONSTRATION

| | |
|---------------------|--------------|
| TRS-80 16K LEVEL II | 507 inc vat |
| 32K Interfaces | £347 inc vat |
| 16K Interface | £247 inc vat |
| TRS232 Interfaces | £37 inc vat |

ALL MUST BE CLEARED SO MAKE US AN OFFER WE CAN'T REFUSE!

Telephone 01-499 6987
Telex 893179
COMPUT-A-CROP
184 Streatham High Road
London SW16 1BJ

• Circle No. 224



NASCOM 1 & 2

INVASION EARTH (NS/G) — fast M/C code version of the popular arcade, pub game/4 INVADER types/ Intelligent homing, exploding, angled, direct, multiple warhead & radio-jamming missiles/40 skill levels. Only £9.95!

SUPER STARTREK! (min 16K) — your mission, Cpt. Kirk, is to destroy the Klingon fleet & save the Federation. Phasers, photon tubes & computer operational! £9.95.

| | | | |
|----------------------------|-------|------------------|-------|
| (Super) LIFE (G) | £8.95 | Renumber | £6.95 |
| Alien Labyrinth (NS/G/16k) | | Driver (NS/G) | £6.95 |
| Space Fighter (NS/G) | £7.95 | Stock Market | £6.45 |
| Secret Agent (NS/G) | £5.95 | Labyrinth (NS/G) | £5.45 |
| Sheepdog Trial (NS) | £5.95 | Death Run | |
| Submarine Chase (G) | £5.45 | NS/G | £6.95 |
| | | Code-Breaker | £4.95 |

NASCOM 1 — Cottis Blandford cass. Interface-load STARTREK in 2 mins NOT 10! £14.90 or £11.90 with program.

WRITTEN ANY PROGRAMS? — WE PAY HANDSOME ROYALTIES! (N.B. Comping shortly — Program Competition).

Send Chq/P.O. + 45p/order p&tp or Sae for catalogue. Telephone (0532) 683186 **PROGRAM POWER** (G = graphics, NS = Nas-sys 5 Wensley Road, only) Leeds LS7 2LX. **TRADE ENQUIRIES WELCOME**

• Circle No. 225



APPLE & ITT2020 BUSINESS SOFTWARE

Professionally written packages now available with comprehensive manuals, built-in validity checks, interactive enquiry facilities, user options, satisfying accountancy, Inland Revenue and Customs & Excise requirements. On diskette under DOS 3.2. in Applesoft with SPACE utility. Not adaptations. Written for Apple System. Support all printer interfaces. Sales, Purchases and General Ledgers £295-00 each.

Manual only £3.

Payroll £375. Manual only £4.

General Ledger supports Incomplete Records, Job Costing, Branch and Consolidated Accounts etc.

General Ledger Applications Manual £10.

Prices exclusive of V.A.T. From our shop or your nearest stockist.

COMPUTECH SYSTEMS

168, Finchley Road, London, N.W.3.

Tel: 01-794 0202

• Circle No. 226

Nene College Northampton

MICROPROCESSOR TECHNOLOGY

A range of one-day-and three-day courses covering both hardware and software aspects.

Full details on application:

Microprocessor Court Tutor

School of Technology

NENE COLLEGE

St. George's Avenue

NORTHAMPTON

NN2 6JB

• Circle No. 227

Sinclair ZX80 SOFTWARE

BATTLESHIP
NIM
SIMON
HURKLE
LUNAR LAND
WATER BILL

WORDPUZZLE
MONEY LOAN
TANK
MASTERMIND
DALLAS

HANGMAN
BANDIT
MATHS TEST
DICE THROW
BIG BEN

All the above programs are available for the 1K ZX80. Each program is supplied on its own C12 Microprocessor cassette with full documentation and listing. £5 each, 3 for £12 or send £2.50 for a sample program and catalogue. Cheques to:

CDS MICRO SYSTEMS
10 WESTFIELD CLOSE
TICKHILL, DONCASTER DN11 9LA
MAIL ORDER ONLY

• Circle No. 228

avrohurst LTD.

- Systems Analysis & Programming
 - QUANTITY SURVEYING SYSTEMS
 - Payroll, Accounting & Invoicing
 - Hardware supplied if required
- Enquiries — tel or write
Avrohurst Ltd. 186, Beehive Lane, Chelmsford CM2 96J
tel: 354685

• Circle No. 229

ATTACHE

Attache: 8080, 64K RAM, S-100, parallel port, 8in. discs, business system. Friargrove Systems Ltd, 494 Great West Road, Hounslow, Middlesex (01) 572 3784.

From £1,737 to
£7,000

BASF

System 7100: Z-80A, 64K RAM, RS232, 5¼in. discs, business systems. MPR, 293 Grays Inn Road, London WC2. (01) 837 6332.

From £4,937

BILLINGS

BMS: Z-80A, 64K RAM, 8in. 200MB hard discs, business system. Mitech Data Systems, 8 Guildford Road, Woking, Surrey. (04862) 23131.

From £4,295

B L MICROELECTRONICS

Biproc: Z-80 or TMS9980 kit, 1K RAM, 2K monitor, RS232, cassette, TV. BLM, 1 Willow Way, Loudwater, High Wycombe, Buckinghamshire HP11 1JR. (0494) 443073.

From £150

BLEASDALE COMPUTER SYSTEMS

UDS: 8080, Z-80, 6809, 32K-1MB, Multibus, CP/M, 5¼in., 8in., hard, RS232, four parallel ports, IEEE 488, development system. Bleasdale Computer Systems, Francis House, Francis Street, London SW1. (01) 828 6661.

P.O.A.

BRUTECH ELECTRONICS

BEM: Single-board processor with 6502 and no RAM. Data Precision Equipment, 81 Goldsworth Road, Woking, Surrey GU21 1LJ. (04862) 67420.

From £133

BYTRONIX MICROCOMPUTERS

Megamicro: 8080/Z-80, 64K RAM, 8in. discs, CP/M. Business and university use. Bytronix, 83 West Street, Farnham, Surrey GU9 7EN. (0252) 726814.

From £6,080

CANON BUSINESS MACHINES

Canon BX-1/BX-1d: 6800, 64K RAM, 5¼in. integral, RS232, V24 ports, business use. Canon Business Machines, Wadden House, Stafford Road, Croydon, Surrey. (01) 680 7700.

From £3,250

COMMODORE BUSINESS MACHINES

Pet: 6502, 8-32K RAM, IEEE ports, integral 9in. screen, personal and general use. Reviewed August 1979.

From £460

8000 Series — SuperPet: Upgrade of original Pet. 12in. screen, 5¼in. discs, business and general use. Reviewed October 1980.

From £895

Kim-1: 6502, LED six-digit display, 1K RAM, cassette and Teletype interface, evaluation board for 6502 chip. Commodore Business Machines, 818 Leigh Road, Slough Industrial Estate, Slough, Berkshire. (75) 74111. Reviewed November 1978.

From £99.95



COMPSHOP

UK101: 6502, 4-8K RAM, TV interface, RS232, full keyboard, single-board, personal use, similar to Ohio Superboard. Compshop, 14 Station Road, New Barnet, Hertfordshire EN5 1QW. (01) 441 2922. Reviewed May 1980. *From £199 for kit*

COMPUCOLOUR

Compucolour II: Z-80, 8-32K RAM, 5¼in. integral discs, 13in. colour VDU, RS232. General use. Dyad Developments. The Priory, Great Milton, Oxfordshire OX9 7PB. (08446) 729. Reviewed June 1979. *From £998*

COMPUCORP

655-675: Z-80, 60K RAM own OS but will run CP/M with modifications, RS232, IEEE and others optional. 1-4 5¼in. discs, 16by80 VDU. Business use. Barnet House, 120 High Street, Edgware, Middlesex. (01) 952 7860. *From £2,595 to £4,750*

COMPUTER CENTRE

Minikit: Z-80, 16K RAM, serial and parallel, 5¼in., CP/M, S-100. *From £800*
Maxikit: Z-80, 16K RAM, serial and parallel, 8in., CP/M S-100. *From £911*
 Computer Centre, 9 De la Beche Street, Swansea SA1 3EX.

COMPUTHINK

Act System 800: 6502, 48K RAM, full keyboard, graphics, 5¼ or 8in. discs, 12in. VDU integral. Business system. Act, 66-68 Hagley Road, Edgbaston, Birmingham B16 8PF. (021) 455 8686. Reviewed February 1980. *From £4,000*

CROMEMCO

Single Card Computer: Z-80, S-100, 1K RAM, 20mA/RS232. *From £273*
 OEM and industrial use.

Z2: Z-80, 31A power supply, motherboard, 21 sockets, serious hobbyist and OEM use. Reviewed February 1979. *From £573*

Z2-H: Z-80A, 64-512K RAM, S-100 bus, CDOS, 10MB formatted fixed disc, two 5¼in. discs, hard discs up to 70MB. *From £5,373*

System 2: Z-80A, 64-512K RAM, S-100 21 slots, CP/M, VDU, two 5¼in. discs, hard discs up to 70MB. Multi-channel interface available. General/business use. *From £2,095 to £6,408 for seven users*

System 3: Z-80A, 64-512K RAM, S-100, CP/M, two or four 8in. discs, hard discs up to 70MB, general/business use. Datron Microcentre, 2 Abbeydale Road, Sheffield S7 1FD. (0742) 585490. Microcentre, 30 Dundas Street, Edinburgh EH3 6JN (031) 556 7354. Comart, PO Box 2, St Neots, Huntingdon, Cambridgeshire PE19 4NY. (0480) 215005. *From £3,568 to £8,304 for seven users*

DATA APPLICATIONS

DAI Personal Computer: 8080, 8-48K RAM, colour graphics, 20 Eurocard industrial interface modules, RS232, industrial use. Data Applications, 168 Dyer Street, Cirencester, Gloucestershire GL7 2PF. (0285) 2588. *From £998*

DIGITAL MICRO SYSTEMS

DSC-3: Z-80, 64K RAM, CP/M, 8in. discs, hard discs up to 28MB, RS232/V24, business and general use. *From £3,445*

6800 SOFTWARE

- **EDITOR ASSEMBLER**, supports all motorola mnemonics. Plus directives FCC, FCB, FDB, ORG, EQU, RMB, REM. 4K at 8000. Listing + Manual. £19.65
- **STANDARD ASSEMBLER**, as above without editor facilities. 2½K data/listing £7.50
- **DIS ASSEMBLER**, very powerful, converts object code to source code in a format suitable for reassembly. Has double check for valid opcode. Appx 2K data/listing £7.50
- **4K BASIC INTERPRETER** suitable for ROM.C000-D000. Powerful arithmetic 9 digit E99. Manual + listing £9.50
- **REALLOCATOR**, relocates your machine code programs to run at another address. Monitor subroutines unaffected. Appx 1K data/list £5.50
- **DEBUG TRACER**, single step through your program, displays CC, A, B, INDX, SP, DATA, ADDR. Registers and memory can be altered whilst running. Appx 1½K £4.25
- **Standard 300 baud cuts tapes** available £2.00 extra per program.

OTHER SOFTWARE INCLUDES Basics, monitors, games etc. Send 50p for catalogue (deductable 1st purchase)

J. MORRISON (Micros)
 2 Glensdale Street,
 Leeds 9, Yorkshire
 Telephone: Leeds 480987

• Circle No. 230

COMPUT-A-CROP

TRS-80 FUNCTIONAL SOFTWARE
 Many financial and statistical functions
ACCOUNTS AND FINANCE
CASSETTE
CHECKBOOK II
 Checkbook balancing and reconciliation
DISK
CHECKBOOK II
ANALYSIS PAD — column or calculator
CHECK REGISTER ACCOUNTING
SYSTEM — Maintains up to 60 accounts
 + balancing and reconciliation.
 SAE for price list and catalogue to
COMPUT-A-CROP
 184 Streatham High Road
 London SW16 1BJ 01-499 6987

• Circle No. 231

apple II/ITT 200 relocated integer

Enables any Integer programme to run on an Apple II Plus/ITT Palsoft machine without an Integer card. Specify memory size when ordering.
 Cassette Systems £12 Disc Systems £14

SPEED CONTROL/PAGE LIST

Adjustable text output speed using the game control paddle. Use to list/edit Integer, Floating Point, and Monitor programmes and also incorporate in your own programmes.

Supplied on Cassette £8, or Disk £8

AUTO-INDEX

Master-catalogue programme featuring fully automatic updating facility and Comprehensive Edit & Interrogation routines. Requires 48K and one disk drive £18.00.

D. J. BOLTON, 1 BRANCH RD, PARK STREET, ST. ALBANS. TEL: PARK STREET (0727) 72917.

• Circle No. 232

TANDY TRS-80 TEXAS TI-99/4 in Bedfordshire

ELECTRON SYSTEMS
 6, PARK ROAD, SANDY
 Telephone 0767-81195

• Circle No. 233



MASTERMIND?

Then you will appreciate how far **SUPERBRAIN** and **CIS COBOL** can go. Contact Bill Whaley at *The Micro-Solution*, sole UK distributor of **CIS COBOL** and **FORMS 2** for **SUPERBRAIN**, and you can mastermind a whole range of new opportunities for your **SUPERBRAIN** today.

THE MICRO-SOLUTION
PARK FARM HOUSE,
HEYTHROP,
CHIPPING NORTON, OXON
TEL: (0608) 3256

• Circle No. 234

Business Systems Systems Development

Programs designed
and written for North Star
and CP/M computer systems

Consultancy

- Feasibility studies
- Independent advice
- Project management
- Single source supply of complete systems.

We specialise in accounting,
order processing, invoicing
and stock control systems.

McMillan Computing Services
3 Tithebarn Grove
Calcot, Reading
Tel: 0734 414751

• Circle No. 235

ADD FULL GRAPHICS TO YOUR VDU!

Does your VDU Home Computer use the Thomson SFF96364 VDU chip? (eg. Triton, Elekterminal) And do you want **FULL GRAPHICS** and **LOWER CASE CHARACTERS**? Then you need the **AUTO ELECTRONICS 96364G GRAPHICS MODULE**. When used in conjunction with the SFF96364 it gives access to the full 8x12 dot matrix per character not just 7x5. This allows ANY customised character set to be used (eg. Arabic) or graphics set or even high definition graphics. Character information is stored in EPROM (or even RAM) which completes the circuit. The module measures 4x4x1.3 cms. and consumes 20 mA at 5 volts. 96364G Graphics Module (with full data) **£12.65**

96364GP Ready Build PCB with Graphics Module and socket for 2716/2708 EPROM (with full data) **£23.00**

2716 (5volt) Custom Programmed with your Character set **£26.45**

Prices include VAT and Postage.
Write or phone for data.

AUTO ELECTRONICS,
MOOREND GROVE,
CHELtenham, GLOS GL53 0EX
(0242) 515133 (after 6pm)

• Circle No. 236

DSC-4: Z-80, 128-512K RAM, CP/M, 8in. discs, hard discs up to 28MB, RS232, RS422, business and general use.

From £3,995

Hex-29: AMD 2900 16-bit, 64K-1,024K RAM, Hex bus, 8in. discs, hard discs up to 28MB. Eight to 32 ports, RS232. Modata, 30 St Johns Road, Tunbridge Wells, Kent TN4 9NT. (0892) 41555.

From £6,445

DURANGO

F85: 8085, 64K RAM, own bus and OS, graphics, four RS232 ports, integral 9in. VDU, 9 x 9 printer, keyboard and two 5¼in. disc drives. General use. Comp Ancillaries, 64 High Street, Egham, Surrey. (07843) 6455.

From £7,500

DYLE HOUSE

System 2000: Z-80, 64K RAM, dual 8in. discs, own OS, business use. Dyle House, 36 Abbot Way, Wellingborough, Northamptonshire. (0933) 79135.

P.O.A.

DYNABYTE

DB8/1.2.4.5.6.7: Z-80, 32-64K RAM, S-100, CP/M, MP/M RS232, 5¼ or 8in. discs, hard discs up to 96MB, expands to multi-task/user system. Business use. Bill Miller, Dynabyte, 25 Park Road, Falsgrave, Scarborough, Yorkshire. (0723) 65559/73338.

From £1,600 to £12,000

EACA

Video Genie EG3003: Z-80, 16-48K RAM, S-100, CP/M, 5¼in. discs, RS232, personal and general use. Lowe Electronics, Bentley Bridge, Chesterfield Road, Matlock, Derbyshire DE4 5LE. (0629) 2430. Reviewed February 1980.

From £369

EQUINOX

200: Z-80, 64-512 RAM, S-100 bus, CP/M, Omnix, MicroCobol, MVT FAMOS, cartridge disc, six serial and one parallel port, business use.

From £7,500

300: WD-16, 64-256K RAM, S-100 bus, CP/M, Omnix, MicroCobol, MVT FAMOS, cartridge disc drive, six serial ports, business use. Equinox, 16 Anning Street, New Inn Yard, London EC2A 3HB. (01) 729 4460/(01) 739 2387.

From £10,500

EUROCALC

Euroc: 8080, 64K RAM, 8in. discs, 15in. VDU, CP/M, business use. Eurocalc, 55/56 High Holborn, London WC1. (01) 405 3113.

From £8,000

EXIDY

Sorcerer: Z-80, 16-48K RAM, S-100, RS232, CP/M, 5¼in. discs. Plug-in ROM pack programs. Liveport, The Ivory Works, St Ives, Cornwall TR26 2HF. (0736) 798157. Reviewed May 1979.

From £399 from Compshop

GNAT

System 10: Z-80, 65K RAM, own bus, CP/M, graphics, 5¼in. discs, RS232, RS449, 12in. VDU, full keyboard, optional IEEE. Business use. Millbank Computers, 98 Lower Richmond Road, London SW16. (01) 788 1083.

From £2,995

Buyers' Guide

HAYWOOD

Systems 1000-8000: Z-80, 32-65K RAM, 6000 is S-100, 3000 single-board, CP/M, graphics, 5¼in. discs, three serial and parallel ports. Business, scientific and general use. Haywood Electronics Assoc., 11 Station Approach, Northwood, Middlesex. (01) 428 9831. *From £2,359*

HEATH/ZENITH

H8: Single-board WH8 assembled, 8080, 16K-65K RAM. Heathbus nine slots, cassette interface, nine-digit LED. *From £321*

Z89: Z-80, 16-48K RAM, CP/M, integral 5¼ in. drive, optional dual external, two RS232, full keyboard, 12in. VDU. *From £1,570*

WH-11A: LSI-II, 16-bit, 16-32K RAM, own bus and OS, optional dual 8in. drives, serial and parallel ports. Heath Ltd, 11b Bristol Road, Gloucester GL2 6EE. (0452) 29451. (01) 636 7349. *From £1,250*

HEWART

6800Mk II: 6800 single-board, 1K monitor, 1K user RAM, 1K VDU RAM, 128byte scratchpad, education and home user. S-50 bus. *From £155*

6800S: 6800, 16K monitor, 8K Basic in ROM, graphics, 5¼in. drive. Hewart, 95 Blakelow Road, Macclesfield, Cheshire. (0625) 22030. *From £229*

HEWLETT-PACKARD

85A: 16-32K RAM, 32K ROM, IEEE 488, RS232, graphics, 5¼in. drives, integral 32 × 16 VDU, integral thermal printer, QWERTY and numeric keypad. Scientific use. Hewlett-Packard, King Street Lane, Winnersh, Workingham, Berkshire. (0734) 784774. *From £1,830*

INDUSTRIAL MICROSYSTEMS

Series 5000: Z-80, 16-56K RAM, CP/M, S-100, two or three 5¼in. discs, two serial and one parallel port, desk unit, business and general use. *From £1,500*

Series 8000: Z-80, 64-256K RAM, S-100, CP/M, MicroCobol, MVT FAMOS, Omnix, two, three or four 8in. disc drives, two serial and one parallel port, desk unit, business and general use. Equinox, 16 Anning Street, New Inn Yard, London EC2A 3HB. (01) 739 2387/(01) 729 4460. *From £2,500*

INSTAR

Omega: 16-bit, 48-256K RAM, dual floppies, hard discs, up to 12 simultaneous users, business use. *From £7,500*

Asatayd: Z-80, 16-56K RAM, dual floppies, CP/M, S-100 bus, business use, Instar, 61 High Street, Croydon, Surrey CR0 1QD. (01) 680 5330. *From £4,950*

INTERTEC

Superbrain: Z-80, 64K RAM, 256 static RAM, dual Shugart, optional hard disc, CP/M, S-100 bus, business and general use. Encotel, Succombs Hill, Upper Warlingham, Surrey. (820) 5701. Sun, 138 Chalmers Way, North Feltham Trading Estate, North Feltham, Middlesex. (01) 751 6695. KGB, 88 High Street, Slough, Berkshire. (75) 38581. Reviewed April 1980. *From £1,495*

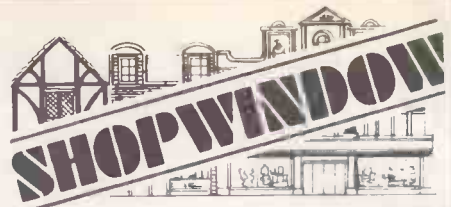

COMPUT-A-CROP

TRS-80 FUNCTIONAL SOFTWARE
Produce standard letters and reports with
DATABASES to merge with your
"Electric Pencil" or "Scriptit"
CCASSETTE
INFORMATION SYSTEM
DISK
INFORMATION SYSTEM
DATA MANAGER
BUSINESS MAIL SYSTEM
Each under £50 inc. VAT
Send SAE for price list and descriptive
catalogue to
COMPUT-A-CROP
184 Streatham High Road
London SW16 1BJ 01-499 6987

• Circle No. 237

2 heads are better than 1



Impetus offers a personalised programming service in accounting and file management. Headed by an experienced accountant plus an expert mainframe programmer, they together bring an expertise to your problems.

The Company specialises in incomplete records for accountants — a complete package with flexible input procedures which can be modified by the operator; stock control, open-item purchase and sales and nominal ledger systems.

Impetus can also provide a complete payroll package which has been especially designed for first time users to simplify tax, national insurance and many other calculations such as pension schemes. Word processing is another area where the expertise behind Impetus is put to good use.

The Impetus programming service is ready to be of use to you.

Telephone or write:
IMPETUS Computer Systems

impetus

Computer Systems

Classic Offices,
Hendon Central, London NW43NN
Tel: 01-202 2726
01-202 9630 (24hr. service)

• Circle No. 238

TRS-80 System

All items stocked, Barclaycard, Access & American Express are welcome, or apply for your own **RADIO SHACK Charge Card**. U.K. Delivery by Securicor. Direct and Personal Exports.

RADIO SHACK LTD.
188 Broadhurst Gardens,
London NW6 3AY.

Tel: 01-624 7174 Telex 23718

• Circle No. 239



SUFFOLK MICROS!

SHARP — NASCOM
NORTHSTAR
SEE SHARPS INCREDIBLE
MICRO

Full software-hardware
support-programs professionally
written to your specification.

C.J.R.

MICROTEK

IPSWICH (0473) 50152

• Circle No. 240

WHEEEE — BANK — POP

NEW SOUND BOARD FOR MOST
COMPUTERS.

SOUND BOARD £40 BUILT £35 KIT

TUNES — CHORDS & EFFECTS — FULLY
PROGRAMMABLE
CONNECTS TO 10 BITS OF ANY I/O PORT
LOUDSPEAKER, AMP & BATTERY
INCLUDED.

CASED + £3

(USES AY-3-8910)

JOYSTICKS £15 PER PAIR (BUILT)

CASED & COMPLETE WITH 2 PUSH
SWITCHES & 1 METRE OF CABLE PER UNIT
PAIR OF 2 AXIS JOYSTICKS CONNECTS
DIRECT TO MOST 8 BIT I/O PORTS.

COMPUKIT/SUPERBOARD

OWNERS: I/O PORT £40 BUILT £35 KIT

24 LINE I/O PORT COMPLETE WITH 2 8T28
BUFFER CHIPS AND ON BOARD RELAY.
PLUGS STRAIGHT IN TO 40 PIN EXPANSION
SKT.

LIGHT PEN £15 INC SOFTWARE

USES OUR I/O PORT. HARDWARE,
SOFTWARE & MANUAL SUPPLIED.
IK101 ONLY)

NASCOM OWNERS MIC CODE PGMS

KINESIS-SOUND BOARD OPERATING
SYSTEM. COMPOSE TUNES & PROVIDE
GRAPHICS. NEEDS 16K £15

BRICKS & TENNIS • 2 JOYSTICK GAMES •
USES OUR JOYSTICKS. £3.50

SPACE INVADERS & CATCH THE CRITTERS
£3.50

STATE MONITOR WHEN ORDERING.

ALL SOFTWARE ON TOP QUALITY
CASSETTE.

ALL PRICES INCLUDE VAT, P+P
ALL EX STOCK

HYSPEC

P.O. BOX 39,

LITTLEHAMPTON,

WEST SUSSEX BN17 6NZ

• Circle No. 241

EXIDY SORCERER

48K £849 + VAT

32K NOW ONLY £799 + VAT

Dealer for

Bristol and South West

ELECTROPRINT (Mr. Tasker)

5 Kingsdown Parade • Bristol 6 • 292375

• Circle No. 242

ITHACA INTERSYSTEMS

Pascal Micro DPS1: Z-80, 64K-1MB RAM, full IEEE S-100 bus, CP/M version 2.2, graphics 8in. and hard discs, RS232, four parallel and two serial ports per S-100 board. Ithaca Intersystems, 58 Crouch Hall Road, London N8 8HG. (01) 341 2447.

From £4,258

ITT

2020: Built under licence from Apple, expires at end of 1980. See entry under Apple II. ITT, Star House, Mutton Lane, Potters Bar. (77) 51177.

From £827

KEMITRON ELECTRONICS

UDS 3000: Z-80, 1-64K RAM, Kbus, own OS, CP/M, 8in. and hard discs, ports up to 256. Kemitron Electronics, (0244) 21817.

From £640 to
£4,000

LOGABAX

LX-500: Z-80, 32K RAM, S-100, CP/M dual 5¼in. drives, business use. LogAbax Ltd., 1-7 Wesley Avenue, London NW10. (01) 965 0061.

From £3,000

LSI COMPUTERS

M-One: 8080, 8-16K RAM, own OS, dual Shugart 8in. drives, two serial and one parallel port, 12in. VDU and full keyboard. Business use.

From £5,995
with software
package

M2: 8085, 64K RAM and 4K EPROM. To be launched in December 1980. LSI Computers, Copse Road, St Johns, Woking, Surrey GU21 1SX. (04862) 23411.

P.O.A.

LUXOR

ABC 80: Z-80, 16-40K RAM, 12in. VDU, IEEE 488, RS232, 5¼in. drives, loudspeaker, personal and education use. CCS Microsales, 7 The Arcade, Letchworth, Hertfordshire ST6 3ET. (04626) 73301.

From £795

MICRO V

Microstar: 8085, 64K RAM, three RS232, serial inputs, StarDOS, twin 8in. drives, general use. Microsense, Finway Road, Hemel Hempstead, Hertfordshire HP2 7PS. (0442) 41191.

From £4,950

MICROMATION

Z-Plus: Z-80, 64K RAM, S-100 bus, CP/M (3), MP/M two serial and six parallel ports, business use. Rostronics, 115-117 Wandsworth High Street, London SW18 4HY. (01) 874 1171. Reviewed May 1980.

From £3,950 to
£8,550

MICRONEX

MX-100: Z-80A, 64K RAM, S-100 bus, RS232, CP/M, Pixel graphics display system, twin 8in. drives. Micronex, Harford Square, Bristol BS18 8RA. (027) 589 3042.

From £3,485

MIDWEST SCIENTIFIC INSTRUMENTS

MSI 6800: 6800, 16K-56K RAM, 5¼ or 8in. or hard discs up to 10MB. Systems 1,2,7 and 10. System 7 runs Flex, MSI, DOS and SDOS, RS232. System 10 is System 7 with hard disc. Business use.

From £1,100 to
£12,000

Buyers' Guide



Strumech (SEED), Portland House, Coppice Side, Brownhills, Walsall, West Midlands. (279) 4321. Reviewed March 1980.

MODULAR BUSINESS SYSTEMS

Tutor: 8085, 32-64K RAM, Intel Multibus, CP/M, optional graphics, twin 5¼in. drives or four 8in., two RS232 serial ports. *From £2,500*

Elite: 8085, 32-256K RAM, Intel Multibus, CP/M, 5¼in. to 24MB hard discs, RS232, 24-bit TTL programmable port. Modular Business Systems, 21 Chappel Lane, Yeadon, Leeds LS19 7NX. *From £5,400 to £25,000*

NASCOM

Nascom 1: Z-80, 2-64K RAM, serial and up to 16 parallel ports, 8K Microsoft Basic, 1K monitor in EPROM. Personal use. Reviewed January 1979. *From £125*

Nascom 2: Z-80, 1K RAM expandable to 256 with Nascom System 80 case. Nasbus, 8K Basic, 2K monitor and 2K character generator, low/high-resolution graphics and colour. 5¼in. single or twin floppy discs, RS232, parallel port, Kansas City cassette port. Nascom Microcomputers, 92 Broad Street, Chesham, Buckinghamshire. (04427) 74343. Reviewed April 1980. *From £295*

NATIONAL MULTIPLEX

Pegasus: Z-80, 48K RAM, S-100 bus, 5¼in., 8in. drives, CP/M, 12in. VDU, business use. London Computer Store, 43 Grafton Way, London W1. (01) 388 5721. *From £2,700*

NEWBURY LABORATORIES

7768: CPU board, 4K RAM, cassette and VDU interface, up to 64K RAM, kit only. *From £45*

NewBrain: Z-80A, 2K static RAM plus 4K static or 16K dynamic, RS232 ports, 16-character, LED display, hand-held. Newbury Laboratories, King Street, Odiham, Hampshire. (025) 671 2910. *From £155 for model without LED*

NEWTRONICS

Elf II: Single-board on 1802, 256bytes to 64K RAM, Hex keypad, RS232 I/O and VDU interface, option keyboard, machine code or Tiny Basic, educational. *From £39 for kit*

Explorer 85: 8085, 4-64K RAM, S-100 bus, RS232, VDU interface, 8080 and Z-80 software, hobbyists and OEM use. Newtronics, 255 Archway Road, London N6. (01) 348 3325. *From £299*

NORTH STAR

Horizon: Z-80A, 16-56K RAM, 5¼in. twin drives, S-100 bus, own OS, business, educational or scientific use. Comart, PO Box 2, St Neots, Huntingdon, Cambridgeshire PE19 4NY. (0480) 215005. Equinox, Kleeman House 16 Anning Street, New Inn Yard, London EC2A 3HB. (01) 729 4460. Reviewed April 1979. *From £995 to £2,500*

OHIO SCIENTIFIC

Ohio Superboard and Challenger I: 6502, 8K Basic in ROM, 2K monitor, 4K RAM, full keyboard and VDU interface. Hobbyist use. Reviewed June 1979. *From £160*

Challenger 2: 6502, 48K RAM, dual 8in. drives, serial port, low-cost business use. *From £1,500*

TRS 80 LIGHT PEN

GIVE SIGHT TO YOUR MICRO! COMMUNICATE DIRECT WITH TV SCREEN. CONNECTS TO STANDARD TRS 80 LEV 2. £16 INCLUDES FULL INSTRUCTIONS AND SAMPLE SOFTWARE
B.J. AMBROSE
15 ELM SHAW RD,
PUTNEY, LONDON, SW15
MAIL ORDER ONLY

• Circle No. 243

TOPMARK Computers

dedicated to
APPLE II

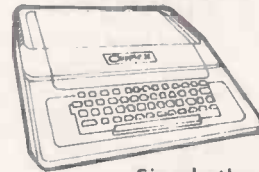

Simply the best!

Full details from Tom Piercy on Huntingdon (0480) 212563 or circle enquiry card.

• Circle No. 244

PIECE-WORK TRS-80

100 COST CENTRE CODES
400 EMPLOYEES
1650 TRANSACTIONS
5 MANAGEMENT REPORTS
£390 + VAT

CLIVE TAYLOR
TAYLOR MICRO SYSTEMS LTD.
HAMSTEAD IND. ESTATE,
OLD WASALL RD.,
BIRMINGHAM B42 1DF
021-358 2436

• Circle No. 245

APPLE/ITT 2020 TOP QUALITY SOFTWARE

SUPER EDITOR. A high-speed machine-code utility routine which lists out every Applesoft line containing a selected variable, Basic command or string, highlighting it in inverse characters and, if required, replacing it, either singly or throughout the program, by another variable, command or string (whatever their respective sizes). Invaluable for editing and debugging.

PACKING SUITE — Strips Rems from Applesoft programs (all references to deleted lines are properly renumbered).

— Packs statements together for maximum speed and optimum memory usage.
— Unpacks multi-statement lines for ease of editing.
Each program is supplied on disk. (32K/48K).

Price — £27.50 each.

BLUE CHIP SOFTWARE
10 Huson Close
London NW3 3JW

• Circle No. 246



MEREFIELD'S ELECTRONICS LTD.

We specialise in memory products — LOW POWER SCHOTTKY — T.T.L. — C-MOS etc.

Sales only, to MFGs and DSTBs (including retail shops).

Please note we have moved to new premises:

Merefields Electronics Ltd
White Horse Lane
Canterbury, Kent

Tel: 0227/64442/60604
Telex: 965386

• Circle No. 247

EXIDY SORCERER

GPW Your South Coast Dealer. New low prices. Engineered systems. Word processing. Business applications.

| | |
|---|----------------|
| 48K | £849.00 + VAT |
| Micropolis Disc Drives for Tandy, Exidy, etc. | |
| 143K | £339.00 + VAT |
| Tandy 315K | £399.00 + VAT |
| 315K (inc. S-100 drive) | £ 699.00 + VAT |
| Exidy 630K (inc. S-100 drive) | £1159.00 + VAT |

GPW ELECTRONICS LIMITED,
55 COBHAM ROAD,
FERNDOWN INDUSTRIAL ESTATE,
FERNDOWN, WIMBORNE,
DORSET

Telephone 0202 893 888
Telex 417111

• Circle No. 248

APPLE II

is now available in
GUILDFORD/GODALMING
area

Visicalc; Desktop Plan;
Word Processing; Database;
Sales, Purchase & Nominal
ledgers

Contact:

Raymond H. Bowesman
SURREY MICROS LIMITED
Tel: Godalming 22318

• Circle No. 249

BRISTOL & WEST APPLE SHARP MZ 80K H-P 85A

dbm Systems & Software
58 Victoria St., Bristol 1
Telephone 0272 214093

• Circle No. 250

Challenger 3: 6502, Z-80 and 6800, 48-56K RAM, OSI 48-pin bus, serial port for VDU, CP/M, expands to eight users, 10, 20 and 75MB hard disc, business use.

From £2,300

Challenger 4: Similar to Challenger I but 64 × 32 display, colour and sound option. U-Microcomputers, Winstanley Industrial Estate, Long Lane, Warrington, Cheshire WA2 8PR (0925) 54117/8. CTS (0706) 79332. Millbank, 98 Lower Richmond Road, London SW16. (01) 788 1083. Reviewed September 1979. Mutek, Quarry Hill, Bath, Wiltshire. (0225) 743289.

From £450

PANASONIC

Panasonic: 8085, 56K RAM, full keyboard, integral 24 × 80 VDU, integral twin 5¼ or 8in. floppy drives. Three RS232, business use. Panasonic Business Systems, 9 Connaught Street, London W2. (01) 261 3121. Reviewed June 1979.

From £4,150

PROCESSOR TECHNOLOGY

Sol: 8080, 16K RAM, S-100 bus, 5¼in. drives, VDU integral, business system. Comart, PO Box 2, St Neots, Huntingdon, Cambridgeshire PE19 4NY. (0480) 215005. Reviewed July 1979.

From £1,750

RAIR

Black Box: 8085, 32-64K RAM, dual mini-floppy discs, eight programmable serial ports, RS232, CP/M, hard discs to 10MB, general and business use. Rair, 30-32 Neal Street, London WC2H 9PS. (01) 836 4663. Reviewed November 1979 and August 1980.

From £2,300

RCA

Cosmac: 1802 micro with Hex pad and TV interface. Machine-code programming with Tiny Basic option. HL Audio, 255 Archway Road, London N6 5BS. (01) 348 3325.

From £79
for kit

RESEARCH MACHINES

380-Z: Z-80, 4-56K RAM, RS232, CP/M, twin 5¼ or 8in. discs, high-resolution graphics. Sold principally to higher and secondary education.

From £830 to
£3,500

280-Z: Board version of 380-Z. Research Machines, PO Box 75, Mill Street, Oxford. (0865) 49791.

From £722 for
4K version

ROCKWELL

Aim-65: 6502, 1-4K RAM, full keyboard, RS232, discs, hobby use, Portable Microsystems, Forby House, 18 Market Place, Brackley, Northamptonshire NN13 5SF. (0280) 702017. Reviewed July 1979.

From £250

SATTCO AB

Databoard 4680: Z-80, 16-64K RAM, own bus, full-colour graphics, 5¼in., 8in. and hard discs up to 10MB, 64 interface units. General use. Microsystems Technology, PO Box 5, Knutsford, Cheshire, WA16 9DU. (0565) 52911.

P.O.A.

SCIENCE OF CAMBRIDGE

MK-14: 8060, 256bytes user memory to which ¼K RAM can be added, Hex pad, cassette interface, seven-digit LED, single-board.

From £39



Reviewed May 1979.

ZX-80: Z-80A, 1-16K RAM, 4K Basic in ROM, cassette and TV interface, touch-sensitive keyboard, educational use. 22 graphics. Science of Cambridge, 6 Kings Parade, Cambridge CB2 1SN. (0223) 311488/312919. Reviewed July 1980.

From £79 for kit

SD SYSTEMS INC

SBC-100: Z-80, 1-48K, S-100 bus, Basic in 8K ROM, four ROM sockets, optional 5¼in. drives, RS232 serial and parallel, single-board.

From £155

SD-100/200: Z-80, 64-256K RAM, 8K PROM, S-100 bus, RS232, CP/M, 12in. VDU, twin 8in. drives, business, industrial and general use. Airamco, Unit A2, 9 Longford Avenue, Kilwinning Industrial Estate, Kilwinning, Ayrshire KA13 6EX. (0294) 65533. Barcellos, Kimberley House, Vaughan Way, Leicester. (0533) 26584.

From £3,750

SEN ELECTRONICS

Organiser: Intel 8085, 64K RAM, multi-user Basic, 8in. drives or 20MB hard discs, three RS232, business use. SEN, 5 London Street, Chertsey, Surrey KT16 8AP. (09328) 66744.

From £7,500

SGS-ATES

Nanocomputer: Z-80, 6-64K RAM, Gamma bus, 2K NC-2 monitor in ROM, Basic as option, RS232, cassette interface, Hex keypad. Midwich, 9 Churchgate Street, Old Harlow, Essex. (0279) 411226. Reviewed October 1979.

From £420

SHARP ELECTRONICS

MZ-80K: Z-80, 16-48K RAM, 10in. integral VDU, integral cassette, loudspeaker, 5¼in. disc optional, general use.

From £480

PC-1211: Pocket computer. Programmable in Basic with cassette interface. Sharp Electronics, Sharp House, Thorp Road, Newton Heath, Manchester M10 9BE. (061) 205 2333. Reviewed July 1980.

From £85

SINTROM ELECTRONICS

Periflex 630/48: Z-80A, 32-48K RAM, S-100, CP/M, twin Micropolis 5¼in. discs, two serial and three parallel ports.

From £2,080 to £2,500

Periflex 1024/64: Z-80, 64K, S-100, CP/M, dual 8in. discs, two serial and three parallel. Sintrom Electronics, Arkwright Road, Reading, Berkshire RG2 0LS (0734) 85464.

From £3,100

SMOKE SIGNAL

Chieftain 511-821: 6800/6809, 32-64K RAM, S-50 bus, Flex DOS68/68d/69 dual 5¼in., 8in., dual RS232, video board, wide range of options, general use. Windrush Micro Designs, Gaymers Way, North Walsham, Norfolk. (069) 245189.

From £1,807

SOLID STATE TECHNOLOGY

Athena: 8085, integral dual mini-floppies and mini-cassette, and matrix printer, can be expanded with 10 micros beyond CPU. Memory to 1.2GB. Claims performance similar to DEC PDP-11/34. Butel-Comco, 50 Oxford Street, Southampton, Hampshire SO1 1DL. (0703) 39890.

From £3,000

MICRO ADS

are accepted from private readers only, pre-paid and in writing, 20p per word, minimum charge £2.

TI-59. Excellent Condition £100. Also HP-55 £50. Phone Leeds 507675.

UK101 Computer, fully assembled and tested, in case with 11K ROM and a full 8K RAM. £275 o.n.o. Tel: Bristol (0272) 694713.

MONROE 1810 Programmable Calculator — Cost £2750 2 yrs ago. — accept £250 o.n.o. Friden Flexowriter with ASCII punch & read £125 o.n.o. 2 Olivetti Audit 413's £250 for pair. Meopham (0474) 812691.

INTEL SBC80/05 Single board computer. New and unused with manual £150. Phone 0254 21455 Evenings.

COMPUTER FREAKS SPRING CLEAN: Pet disc drives £625. Exidy Sorcerer 32k £665. Apple Hi-Res light pen £140. Apple Lo-Res light pen £45. Texas TI59 with Master Stat library £145. S-100 CPU board £95. S-100 assembled 16k dynamic RAM board £145. Cheaply expanded to 64k for an extra £90. Versafloppy disc controller (assembled) £115. Shugart SA400 disc drive £175. IBM Selectric with Aculab interface £535. Teleguipment S54A scope £125. Ring Evesham (0386) 870841 for more details.

NASCOM ROM BASIC graphics programs run faster with VORTEX machine-code utilities. Send £10, stating memory size, or sae for further information, to Chris Blackmore 31 Herne Rise, Ilminster, Somerset TA19 0HH.

EPROMS 2708 £5.40p. 2716 £21.60p postage/packing 25p. Software for most micros. Large S.A.E. for lists. Zero One Electronics, 36 Oaklands Avenue, Thornton Heath, Surrey.

AIM-65 with power supply, 3K RAM EDGE CON — nectors, Software including pilot, chess and utilities. £220 ono. Chelmsford 351704.

PET BARGAIN. 32K Business Pet + 2040 dual floppy disc. 8 months old. Little used. £1,200 o.n.o. Phone Gerrards Cross (02813) 83095.

PET 2001-B — fitted upgrade Rom, hobby use only. With manuals and many programs (Tutorials, Utilities and Games) £425. Phone Blackpool (0253) 869108 Evenings/Weekends.

UK 101 Based Microcomputer built into Video Terminal 11K user RAM. Several games, programmes included. Ring 668 8658 £350.

WANTED S100 Z80 micro, Ram, etc cards and VDU. For Sale NASCOM minimal system with PS. £150 and Professional B/W video monitor £100. Phone 0533-62682 Evenings.

Motorola 6800 D2 assembled & tested + extra RAM. £100 ono. 02813 83095.

32K Pet new type keyboard, cassette dust cover, hardly used. £600. Evenings Stockbridge 832. Working hours Stockbridge 766.

FOR SALE: Teletype Corp ASR33 Eight Level 110 baud, good condition — 0493 70437 after 6pm.

COMPUKIT software: startrek, life, zombie, number mastermind, random number contest (you versus UK101), torpedo-boat, anti-aircraft, digital clock (H-M-S). Most require 5k, all recorded both sides C10, £2.50 each. K A Spencer, 33 Alpine Gardens, BATH.

TMS2708 EPROMS £4 each, no VAT, no postage. J. Hawthorne, 23 Iver Lane, Cowley, Middx. Phone: UXBRIDGE 36428.

FOR SALE: One PR40 Parallel Printer with Pet connections £200 ono. Tel: 01-286 8124, Evenings. Ask for Eden.

PET 2001 32K, Cassette deck and cover bought June '79, little used £625.00. Phone Stockbridge (Hants) 832. — home. Office 766/824.

Acorn Computer, excellent introduction Micro, assembled in case, £55. 01-397 6792.

TRS-80 Level 1 16K CPU, CTR80 cassette player; technical and user's manuals; many games on cassette, plugs into your own TV. Mint, only weeks old. £430 o.n.o. 01-668 6450 Evenings.

TRS-80 16K Level 2 Complete, with Library 100 and Chess Programs — £500 o.n.o. — Lincoln 53254 after 6p.m.



Novel program and games cassettes for Pet. Dragon's Maze, Video Football, Demolition, Chemical Analysis, Mark Book Aid and many others. Prices from £2.25 inclusive. SAE for details. P.C. Abraham, 33 Bridge Green, Prestbury, Cheshire.

Personal Computer-Share. Economic rates. 16k Level II Basic microcomputer. Phone Walton on Thames 20642 Tuesdays and Thursdays 5-6 p.m.

Eprom Eraser Ultraviolet Erasing Unit in 400 x 320 x 90mm. Cabinet. Suitable for up to 12 Eproms: £35 + £2 p/p & insurance. Spare U.V. tube with instructions £11.50 + £1 p/p. J.A. Harris, 17 Cottesmore Close, West Bromwich, West Midlands.

Sorcerer 32K 240V 50Hz with technical manual + RS 232 + Software. £690. 01-390 4568.

PROGRAMMING PROBLEMS? Experienced micro-computer programmer seeks all types of programming work. Ring and discuss your requirements. Chris - 01-668 5093.

Commodore Pet 8K £325.00. Tel: 01-953 6921. Expander Pet converts 8K Pet to 32K Pet Computer £225.00. Tel: 01-953 6921.

Computhink 800K Disc for sale. With easily fitted DOS Board for 32K New Rom Pet. Still under warranty. Assistance given with installation. £750.00 o.n.o. Also ADA 1200, RS232/IEEE Interface £50.00. Phone Flitwick 2221.

For Sale TRS-80 Level II 16K plus Numeric Keypad. Keyboard fully debounced. Many extras. Ring Cradley Heath (8) 634798 after 6 p.m.

DO YOU WANT HARD COPY. Printout Service from programs or data SAVED on tape. SAE please for details. P.D. Hingley, 28 Oakley Road, Caversham, Reading, Berks. RG4 7RL.

NORTH STAR Horizon Z-80 Computer ?????? (used) Phone 024-06-2491.

Teletype ASR33, RS232 interface. Excellent condition. £290 o.n.o. Stevenage 60397 evenings.

PET 2001-8K manuals microchess games. Private use virtually new. £420 o.n.o. Wentworth 2503.

TANDY TRS-80 radio shack level 2 - 16K as new. Comprises VDU PSU cassette recorder all manuals many basic books and working tapes. For sale at £450 o.n.o. Tel 0272-826753 (evenings).

TRS-80 Level II, 16K, VDU, Cassette Recorder manuals and some software £400. Also 32K expansion interface, Teac 40 track dual disks, manuals and some software £700. Both for £1050. Telephone Tonbridge (0732) 356728 (evenings/weekends).

TELEPRINTER 28RO with factory handbooks, 110W. Excellent condition £50. 01-599 0197.

PET 8K - 2001 Series, some tapes and manual £475. Cash only. Tel. Glenn Oxford 880663.

SHARP PC1211 Pocket Computer with CE121 cassette interface and manuals. Duplicate present used once. £95. J.M. Spillett, Bay Tree Cottage, Crabbswood Lane, Sway, Lymington, Hants SO4 0EQ.

SPACE Invaders for 4k Superboard. Partly machine code. Mystery Invaders, Splitting etc. £3 from David, 30 Vernon Road, Bury BL8 4DD.

IBM 2740 Golfball Printer/Terminal console. Serial V24 with manuals. 80 column pin feed £550. Tel. Chelmsford (0245) 62668 evenings.

TEXAS TI-59 programmable calculator, PC-100B printer plus structural engineering and maths/utility software modules. £230 (Putney) 01-870 6017 (evenings).

APPLE II Plus 32k with £150.00 worth software. £720.00. 9 inch monitor available £100.00. Aylesbury 631200.

PET Salvage kit adds four commands to Basic, only £2 on cassette. Quote model when ordering from Jones, 24 Clifton Drive, Lytham, Lancs.

NASCOS USERS - BASIC assist. Line renumber, find/change strings, list, list variables used, etc. Fully relocatable, full instructions, £6.50. Also GOMOKU, 3K object code, 3 skill levels, £3.60. Cassette, NASSYS only. Johnson, 14 Shelley Close, Winchester.

OSI, C24P, 8K user RAM + 8K Basic + Dia. convertor + Tone Generator + Case + PSU + Assembler + Manuals. £3.20 o.n.o. (021) 426 3015.

INTEL 8080 based micro, 24K Ram, dual 5 1/4" mini-floppy drive, 24 x 80 VDU, serviced and checked by manufacturer, £1500 o.n.o. Tel. 01-883 6585 mornings or 01-580 6361 afternoons.

SORD COMPUTER SYSTEMS INC

M200 Range: Z-80A, 64K RAM, S-100 bus, Sord OS, graphics, 5 1/4 8in. or hard discs, two RS232, integral 80 x 24 VDU. Business use. Midas Computer Services Ltd, 2 High Street, Steyning, Sussex (0903) 814523.

From £1,850 to £6,950

SOUTHWEST TECHNICAL PRODUCTS

C/09: 6800, 56K RAM, Flex OS, 5 1/4in. 8in. or 15MB hard discs, business, educational and scientific packages.

S/09: 6800, 128K RAM-380K RAM, Uniflex OS, support up to 16 users in foreground and background mode. Southwest Technical Products, 38 Dover Street, London W1X 3RB. (01) 491 7507.

From £3,000 to £10,000

SPENCER JOHNSTON LTD

SJL 8000: Z-80A, 64-208K RAM, integrated database system to user specifications, 8in. discs to 4MB Winchester to 80MB. Sun Computer Services, 60 Broad Lane, Hampton, Middlesex. (01) 979 9824.

From £8,000

SYNERTEC

Sym-1: 6502, 4K-64K RAM, port-expansion kit, TV interface, Kim software, hobbyist use. Newbear, 40 Bartholomew Street, Newbury, Buckinghamshire. (0635) 30505.

From £160

TANDBERG DATA

TDV Series: 8080A, 32-64K RAM, Intel bus, 4K Basic discs system in ROM, one plus three 8in. discs, or 2.5MB disc cartridge, eight ports, semi-graphics, CP/M version available, educational use. Tandberg Data, 81 Kirkstall Road, Leeds, LS3 1HR. (0532) 35111.

From £4,000

TANDY CORPORATION

Model 1: Z-80, 4-48K RAM, RS232, Level I and Level II Basic in ROM, separate keyboard and 12in. VDU, small business and personal use. Reviewed November 1978.

From £349

Model 2: Z-80, 64K RAM, integral 8in. disc, integral 12in. VDU, detachable keyboard, CP/M serial and parallel ports, Level III Basic, business use. Tandy, TRS-80 Division, Bilston Road, Wednesbury, West Midlands, WS10 7JN. (021) 556 6101. Reviewed March 1980.

From £1,995

TANGERINE COMPUTER SYSTEMS

Microtan 65: 6502, 1-48K RAM, Tanbus, IEEE 488, Tanbug in ROM (1K), Pixel graphics, 5 1/4in. discs, 32 I/O lines and three serial ports, from single-board upwards. Tangerine Computer Systems, Forehill, Ely, Cambridgeshire. (0353) 3633.

From £69

TECHNALOGICS

TECS: 6800, 56K RAM, Basic and Prestel terminal software, RS232, two cassette ports, two parallel ports, 5 1/4in. discs. Technalogs, Windmill Works, Station Road, Swinton, Manchester M27 2BU. (061) 793 6323. Reviewed November 1979.

From £895 for kit

TERODEC MICROCOMPUTER SYSTEMS

TMZ-80: Z-80, 64K RAM, CP/M, MP/M, CPNet, twin 8in., up to

From £3,000



32MB hard discs, multi-user business use. Terodec, 17 The Gallop, Yately, Camberley, Surrey. (0252) 874790.

TEXAS ELECTRONIC INSTRUMENTS (TEI)

PT-208/PT-212: 8080, Z-80, 8085, 32-60K RAM, S-100, CP/M, 5¼in., 8in. and hard discs, three RS232 and three 8-bit ports, integral VDU, business use. Abacus Data-type, 62 New Cavendish Street, London W1. (01) 580 8841. Reviewed January 1980. *From £3,500*

TEXAS INSTRUMENTS

TI-99/4: 990 16-bit, 16K RAM, Basic in 26K ROM, high-resolution, colour graphics, up to three 5¼in. discs, joystick, cassette and other ports, RS232, personal use. Texas Instruments Ltd., Manton Lane, Bedford, MK41 7PU. (0234) 67466. Reviewed August 1980. *From £950*

TRANSAM COMPONENTS

Triton: 8080, 32K RAM, CP/M, 1K TB10S in ROM, up to three 5¼in. discs, or four 8in., serial and parallel ports. Reviewed December 1979. *From £296*

Tuscan: Z-80, 8-64K RAM, S-100 bus, CP/M, RS232, TV and cassette interface, from single-board, personal use to full business system. Transam, 59 Theobalds Road, London WC1. (01) 405 5240. *From £150*

ULBRICH AUTOMATION

Powerhouse II: Z-80, 16-32K RAM, RS232, 5in. internal VDU, integral mini-cassette, 2K monitor, IEEE, 14K Basic DOS, OEM users. Powerhouse Microprocessors, 5 Alexander Road, Hemel Hempstead, Hertfordshire HP2 5BS. (0442) 42002. *From £1,200*

VECTOR GRAPHIC

MZ: Z-80, 48K-64K RAM, CP/M, 5¼in. discs, optional graphics, serial and parallel ports. Business and general use. Almarc Data Systems, 906 Woodborough Road, Nottingham (0602) 625035. Reviewed October 1980. *From £2,300*

WESTERN DIGITAL

Pascal Microengine: MCP1600, executes P-code directly, 64K RAM, own bus, 5¼in., 8in. or hard discs up to 18MB, two RS232, two parallel ports. Pronto Electronics Systems, 466-478 Cranbrook Road, Gants Hill, Ilford, Essex IG2 6LE. (01) 554 6222. *From £2,295*

ZENTEC

ZMS-70: 8080A-1, 32/64K RAM, up to 12K ROM, dual integral 5¼in. discs, 600MB, RS232, integral 15in. VDU, 16 function keys. Zigal Dynamics Ltd., Bank Chambers, 13 High Street, Chesham, Buckinghamshire. (02405) 75681. *From £4,000*

ZILOG

MCZ Series: Z-80, 64K RAM, RIO OS, Zilog bus, optional graphics, 8in. discs, and hard discs; four RS232, one parallel, stand-alone or networking. Zilog (U.K.) Ltd, Babbage House, King Street, Maidenhead, Berkshire. (0628) 36131. *From £3,000*

FASTER TYPING on COMPUKIT (Old Monitor only) or SUPERBOARD. BASIC Keywords in one touch. Control-I and INPUT appears on screen; Control-T for TAB (etc. 8K-DRAUGHTS on COMPUKIT, SUPERBOARD or NASCOM II. Play draughts against the computer — it plays a very good game. £2.95 + SAE for each tape (State which computer) to A.R. Leeder, Stratton St. Michael, Norwich, NR15 2QB.

VOICE CHESS CHALLENGER £160; TI 59 £100; TI Printer £100; HP97 £270; all o.n.o. Tel. John Doe (office) Redhill 68126.

ZX-80 + Power supply, ready to go, £85. (Newcastle) 0632 734174.

APPLE II 48K Europlus with disc drive, many discs and programs including Library index, Word processing, Chess and Space Invaders plus many utilities. Less than one year old and still under guarantee. £900 inclusive. Phone Max on 01-743 1272 (ex 6960 (day) or 01-354 1767 (evening)).

SORCERER 32k, Basic, Word processing, two cassette recorders, Hitachi Monitor, 50 programs, tapes, books etc. £800 o.n.o. With Selectric-based printer £1300. Wagner, 319 Beverley Road, Hull HU5 1LG.

EXCHANGE ITT2020, 48k, discs for APPLE Plus system or sell for £1150. Tel. Southend (0702) 283414.

HAZELTINE 2000 VDU. CURsor Addressing, Fore-ground Background Fields, Editing, Cassette Printer Ports. £250. Rugby 810056.

PRINTER Interface. Connect TRS-80 directly to Anadex/Centronics Printer. Complete with cables and connectors. £25. Tel. St. Albans 63483.

ZX80 ACTIVE DISPLAY — now you can write those games or use the ZX80 for 'hands off' continuous data monitoring. This routine lets you decide how long a display will hold before your program continues (1/50 sec — approx. 10 mins), £5.00. MUSIC — tunes to tape like saving programs, no hardware modifications, £1.00. HEX loader/display for machine code programming, £1.00. GRAPHICS — sketching program, poking to memory mapped screen, £1.00. All for 1K memory — Inclusive prices for program listing and details. K. Macdonald, 26 Spiers Close, Knowle, Solihull, B93 9ES.

ZX80. Free leaflet explains how to always successfully LOAD/SAVE. Supplied free with 4 games on cassette, Send £3 or SAE details. Bobker, 29 Chadderton Drive, Unsworth, Bury, Lancs.

TRS-80, LEVEL-II, 16K, Keyboard plus modulator, manuals including 'Learning-level-II' Plus several programs (startrek-micromusic-editasm) £350. Phone BERKHAMSTEAD 71827.

PET 2001/16K, New ROMS, Large keyboard, cassette, extensive software included, £600 o.n.o. Phone Alton (0420) 85131.

DISCOUNT SOFTWARE for Pet 8K new RomS. "Games cassette" includes, Breakthru, UFO, Fighter Pilot, Sea Wolf, Depthcharge, all on a top quality cassette for only £4.00 P&P inc. Argon Software, The Manor, Caunton, Notts. NG23 6AD.

NASCOM I operating Nas-Sys with additional shift key, S100 16K static memory expandable, 8K basic cased. Miratel V.D.U., Centronics — P1 and IBM Golfball Printers. £850 offers or will split, Emigrating. A.F. Dixon, Hitchin 4308.

Two oscilloscopes for sale, Tektronic 545 £100, Solartron £45. Phone Geoff Haydock 04626-76422.

One Commodore Computer 32K large keyboard, printer, 2 cassettes, one complete ("Programme of Accounting") with backup copies. Phone 985 6424 anytime.

SORCERER 32K with Basic and Cassette Recorder £675. Phone 01-421 0266.

SUPERBOARD SPACE INVADERS — Superb, fast graphics, part machine code. Includes full instructions. Just fits into 4K. Only £2.50. Also MK14 for sale. P. Morton, 40A Fairwell Rd, Stockton, Cleveland.

Small quantity of 16K Dynamic Rams for Sale. Very low price for quick disposal. Box No. 110.

I have spare time available to help new micro users in business. For independent advice and programming assistance. Tel: 0454 778833 evenings or weekends.

TRS 80 Level II (New October) 16K, Numeric Pad, VDU, Cassette, Tapes/Books, (List over £700) £495. Tel: 01-989 0430.

Son of Hexadecimal Kid

A parable in eight virtual pages by Richard Forsyth
Page 1 — front page news

When the System died, all the computers and robots which constituted its active elements ceased to function. A very few androids — computerised humans, like Hex — who had, for some reason, been cut off from data communication during the critical period, survived. They soon found that the electrodes implanted inside their skulls, the communications equipment, the auxiliary memories, the on-board brain accelerators and all the paraphernalia of the cybernated man were no longer a boon but a crippling handicap. Nevertheless, some of them kept up the struggle for existence, especially the more unsystematic ones — as Cleo and her friends are about to discover.

The first tinges of dawn had begun to lighten the sky, and they were able to see the strange figure quite plainly. They gazed fascinated as he staggered uphill towards them. He was wearing a trapper's leather jacket which looked as though he had just rolled through two briar bushes. Every so often, he paused and put his hands to his head; it seemed as if he were trying to wrench it from his shoulders.

None of them moved. The stranger was obviously unaware of their presence. He drew closer and closer until, when he was less than three metres away, Piltown 2 took a pace forward into his path and held up a hand.

The stranger lifted his eyes. Seeing the apeman's shaggy bulk, he fell to his knees.

"Help me", he implored. "Data, please — input —".

In a flash, Cleo recognised not only the symptoms, but who he was. It was wild Bill Bootstrap, clearly far into the delirium induced by advanced data deprivation.

"My head hurts", wailed the android. "Please, here — just a byte". He pointed feebly to the parallel I/O port fitted just behind his left ear, then, as if the effort was all he could muster, keeled over and lay still.

Quick and businesslike, Cleo knelt over his fallen body and rolled him on to his back, propping up his head against a boulder. Though she had no reason to be grateful to Bootstrap, her former jailer, his suffering touched her.

It was clear that, by some minor miracle, he had avoided gigosis but was now experiencing withdrawal symptoms of the severest kind in the absence of the all-embracing Network.

She beckoned to McNull.

"Now the error of his ways is revealed unto him and he sees the evil thereof. So be it", pronounced McNull without sympathy.

Cleo ignored his remark. She knew that McNull had applied for cybernation of his own accord as a young man but had failed the

aptitude test. Since then he had nurtured a bitter resentment for all things cybernetic; but, more useful in the present context, his envy had led to a morbid fascination with electronic gadgetry.

Even now, just after escaping by a hair's breadth from the collapsing cavern, his pockets were bulging with LED displays, assorted chips and fragments of discarded circuit board, while the return key from a VDU keyboard he had found somewhere on his travels hung round his neck on string like a lucky charm. These baubles he collected totally haphazardly — without regard to their function or value.

"Hand me that", she said, pointing to a video games paddle that was protruding from his vest pocket.

Reluctantly, McNull obeyed. She took it and pressed it into Bootstrap's hand. His fingers closed about it. It had a warm amber handle and it seemed to comfort the android. At any rate his breathing steadied and he fell into a deep sleep.

She stood up. She knew that Mike Rose had commanded Piltown 2 to obey her orders with his dying breath, and she wanted him to carry Bootstrap. Unfortunately, she could not speak predicate calculus, nor even Esperanto which was the least logical language the Sasquatch could understand. Eventually, by mime, she conveyed her intentions to him, and he humped the motionless body over his broad back.

"Salvation should be denied those that merit it or not", muttered McNull grumpily as they set off. To tell the truth he was very attached to his electronic trinkets and was far from pleased to have one requisitioned to relieve an android who, in his opinion, richly deserved his fate.

As they walked on, he furtively removed his prize possession, a flat-screen micro-television, from an outer pocket and secreted it about his person. That, for sure, was not going to be taken from him — it didn't work, of course, but it

shone beautifully in the morning sunshine.

Cleo thus emerged as the natural leader. Although still 16, and a female to boot, she was the only one who could make decisions on the spot and the only one with an idea of where to go. Piltown 2 was bred for service and so shambled along happily behind her. McNull, when he was not lost in a transcendental reverie, was putty in her hands.

He had inadvertently burnt out that part of his brain which dealt with forward planning in a misguided attempt to fill his head with hobbyist computer kit after the cybernation college turned him down.

Cleo's purpose, which the other two fell in with by default, was to return to Sprocket's Hole as soon as possible. That was where she had last seen her elder sister Lambda, and that was almost certainly where Bootstrap was from. If he could survive the plague of gigosis then perhaps Lambda too — who, unlike Cleo, had been cybernated — was still alive.

The sun hoisted itself above the horizon and suddenly it was a bright desert morning. They trudged on as the day grew hotter, Piltown 2 apparently untroubled by his load, McNull perspiring but uncomplaining, stopping occasionally to shake the sand from their shoes.

Soon after midday, they crested a ridge from which they could look down into Sprocket's Hole. There in the haze lay the two log cabins. Nothing stirred. Cleo galloped down the slope, sliding and slithering on the loose stones, while McNull and the apeman followed at a more sedate pace. As soon as she reached the door of the larger hut, she flung it open.

Lambda she saw almost at once, splayed out half across a bench and half on the floor. Panting, she dragged her into the open air.

"Lambda, Lambda", she called, shaking her sister bodily. "What happened"?

Lambda's eyes did not open but Cleo could hear the whir of her disc drive motors as the

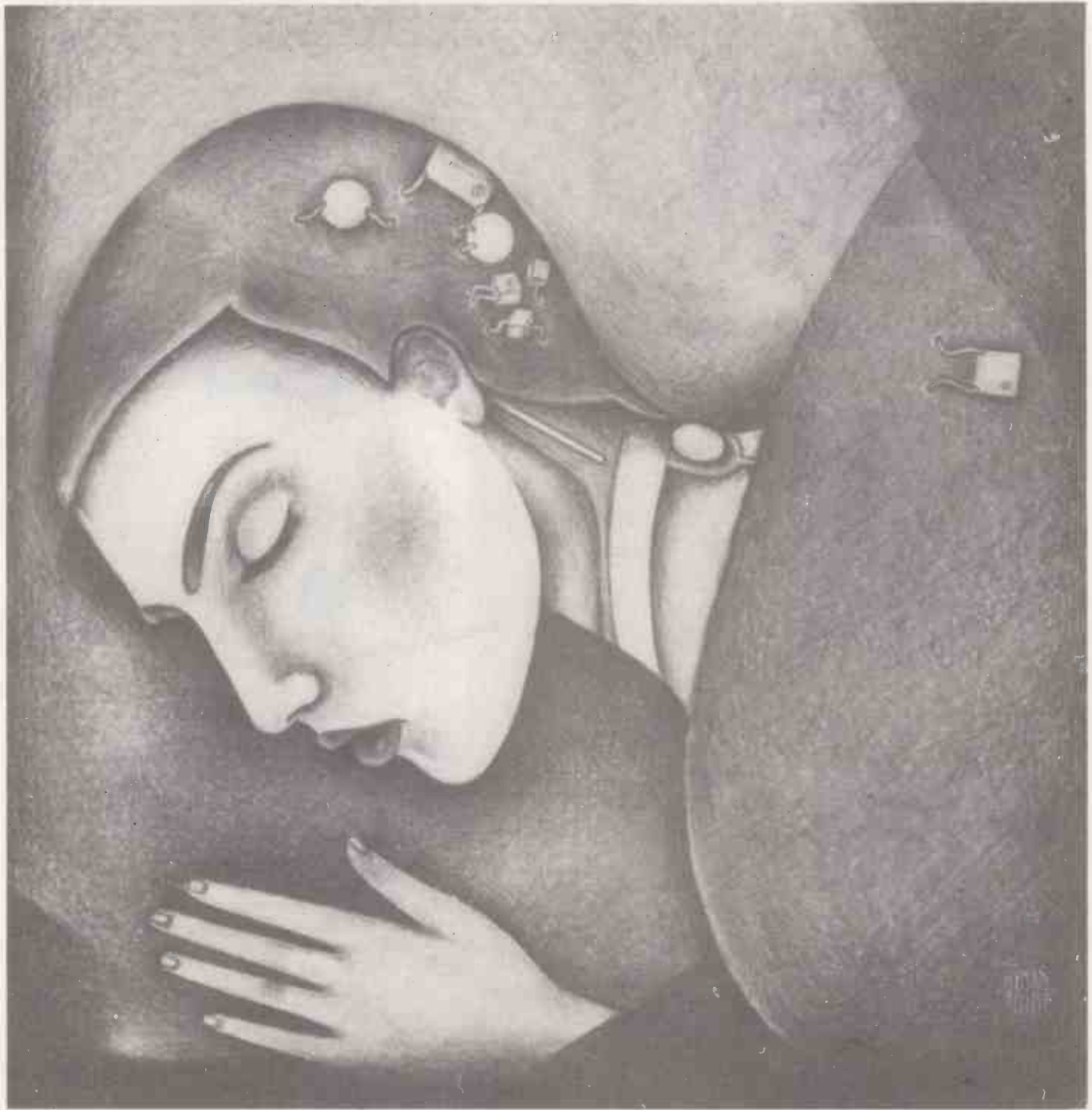

read/write head searched fruitlessly for track zero. Clearly, she had received a massive unregulated surge of power which had wiped clean her PROM loader and possibly corrupted her system diskette.

Cleo dashed back inside to look for a ROM-pack with a fresh copy of the brain-bug loader on it. After a few moments scrabbling around, she found one and emerged just in time to see McNull peering down over her sister.

McNull's well-meaning but electronically incompetent hand strayed towards the re-start button at the back of her neck.

"No", shouted Cleo — but it was too late.

Lambda sat up, opened her eyes and

started to sing Land of Hope and Glory.

"Fool", Cleo snarled at McNull. "Don't you realise how dangerous it is to try a warm-start on an android who hasn't been powered down properly"?

McNull looked crestfallen. He had only been trying to help.

She switched off Lambda, inserted the new ROM-pack and initiated the cold-start procedure.

"This had better work, for your sake", she said, glaring at McNull.

She began counting under her breath. She knew the start-up routine by heart. First there was the memory diagnostic — that took about 10 seconds. Then, the processor would exercise every opcode in combination

with every possible operand which took another 30 seconds.

Finally, there was the disc-verification test which wrote, and read-back, every track on both discs twice — first filling it with zeros, then ones. That took slightly over a minute. If that failed, Lambda's brain, which was alive but which could not communicate with the outside world through the apparatus that encased it, would be trapped for ever inside a coffin of defunct electronic accessories.

After 10 seconds, then 40, still nothing had gone gone wrong. Cleo's heart pounded, making regular counting difficult — 99, 100, 101 — Surely it was time for Lambda to wake up. Next month; a rude awakening. □

**NEW SUPERBRAIN DOUBLE DENSITY £1875
QUAD DENSITY £2250**

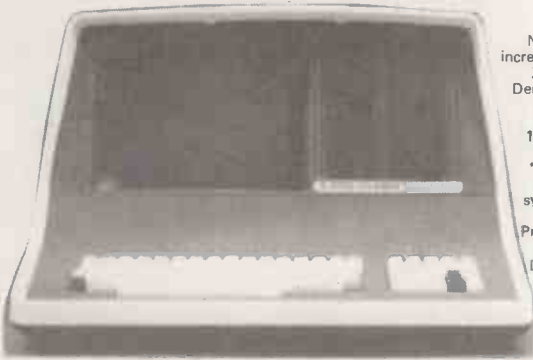

Now with CP/M2.2, and increased disc storage. Twin Z80-A 4MHz. *2 Double Density Disc Drives, giving 350/700K storage *64K RAM. *High resolution 12 inch crt. 80 x 24 lines upper/lower case * 2 RS-232 printer ports. * CPM 2.2 operating system. *MBasic, Cobol, Fortran, Pascal, Word Processing and Accounts packages available. Dealer Enquiries Invited.

TRS-80 MODEL II £1999



State of The Art Second Generation Computer. Over 10,000 already sold in USA. 8 slot bus ensures expansion of hard discs and other peripherals.. 76 Key professional keyboard, self test on power up. TRSDOS and Level III Basic Standard. CP/M available as option, making a wide range of accounting, educational, scientific and word processing packages instantly usable. Nationwide service through 180 Tandy Stores and Computer Centres.

NEW TRS-80 MODEL 1 48K SYSTEM



WITH DUAL DISC DRIVES. £1250. NEW GREEN SCREEN VDU, WITH ROCK STEADY DISPLAY. REDESIGNED 32K EXPANSION INTERFACE WITH TROUBLE FREE DISC OPERATION. TWO 40 TRACK TEAC DISC DRIVES, COMPLETE WITH CABLES. TRIDATA SALES, PURCHASE, INVOICING, PAYROLL PACKAGES AVAILABLE.

LOW COST WORD PROCESSOR I

BASED ON TRS-80 LEVEL 2 16K, CASSETTE RECORDER, ELECTRIC PENCIL SOFTWARE, UPPER/LOWER CASE MOD, PRINTER INTERFACE AND OKI DOT MATRIX PRINTER. COMPLETE READY TO GO £1095. FREE MAILING LIST PROGRAM.

WORD PROCESSOR II

SAME AS ABOVE BUT WITH 48K, 2 DISC DRIVES AND RICOH DAISY WHEEL PRINTER. £2575.

WORD PROCESSOR III

BASED ON SUPERBRAIN COMPUTER SHOWN ABOVE. WITH RICOH PRINTER AND "MAGIC WAND" THE ULTIMATE IN WORD PROCESSING. LETTERS AUTOMATICALLY FORMATTED WITH ADDRESSES FETCHED FROM SEPARATE FILE. COMPLETE SYSTEM. £3395.

INVOICING, STOCK CONTROL, SALES LEDGER, PURCHASE LEDGER, PAYROLL AVAILABLE FOR ABOVE COMPUTERS. FROM £250 PER PACKAGE. Prices quoted above do not include VAT. Phone or call for further details or demonstrations.

60 CHARACTERS PER SECOND

RICOH RP-1600 THE FASTEST DAISY WHEEL PRINTER. £1290 FAST, heavy duty commercial DAISY WHEEL printer, with high quality printout, coupled with low noise necessary for office environment. Nationwide service by NEXOS. 90 day warranty provided at your premises.

124 char: upper/lower case. * 10/12 chars: per inch giving 136 or 163 columns. * 15 inch wide friction platen. * Top of the form, BOLDING, underline, and host of other features. * Centronics type parallel interface as standard. Options: serial interface £60 * PET interface £65 * APPLE interface £75.

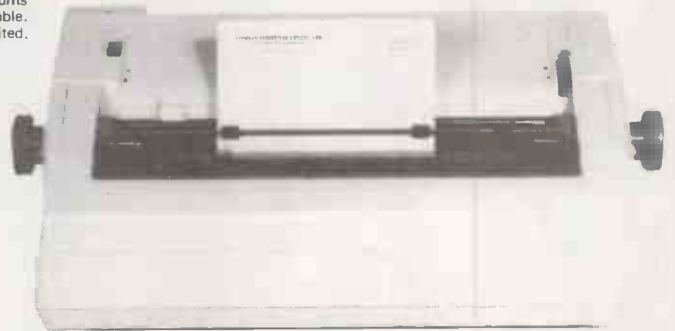

ANADEX DP-8000 NEW LOW PRICE £475. Fast 112 Characters per second. * Both RS-232, and Centronics Parallel interfaces built in * Upper/lower case £ sign.



OKI MICROLINE 80/132. The quiet printer you can live with £495. The quietest Dot Matrix available: 40,80, or 132 cols per line. * excellent print quality * 3-way paper handling: Letterheads, Fan-fold, or Paper Rolls * Graphics * Ideal for software written for large 132 col printers * Continuous rating printing day in and day out * Centronics parallel standard. Options: RS-232, PET, APPLE. Dealer Enquiries invited.



EPSON TX-80 £395

Dot-Matrix Printer with PET Graphics. Prints 80 columns on plain paper at 90 characters/second. Adjustable tractor * Upper/lower case * Double width printing * Micro controlled * Self test * Heavy Duty Print Head using Jewell Bearings for long life * Made by Shinshu Seiki an affiliate of Seiko Watch Co of Japan. Interface: Centronics Parallel. Options: PET, APPLE and Serial.

LONDON COMPUTER CENTRE LTD
43, GRAFTON WAY,

OFF TOTTENHAM COURT ROAD,
LONDON W. 1.

TEL 01-388 5721

OPENING HRS: 11-7 MON-FRI, 12-4 SATS.

NORTHERN DEALER

MICRO SYS LTD

58 HIGH STREET

PRESCOTT

MERSEYSIDE

TEL: 051-426 7271

MIDLANDS DEALER

HORIZON SOFTWARE LTD

REGENT HOUSE

16 WEST WALK

LEICESTER LE1 7NG

TEL: 0533 556550

See us at
COMPEC'80
 stand 6181
 Olympia
 Nov 4-6

Almarc + Vector Graphic

The complete partnership
 in Micro computers

DATA SYSTEMS LTD
 906 Woodborough Road, Nottingham NG3 5QS.
 Tel: (0602) 625035

System 2800.

- * S-100 bus.
- * Switch-selectable asynchronous baud rates between 110 and 9600 bits/second.
- * Vector-3 console chassis with 12-inch CRT (18" W x 12 1/2" H x 21" D).
- * Capacitance Keyboard 6 slot motherboard, and power supply.
- * Z-80 based single board computer with 1 serial port, 3 8 BIT parallel ports, 3 PROM slots, and

1K RAM. Flashwriter II. Video board, 64K dynamic memory board and disc controller. DUALSTOR enclosure with two 8-inch double density disc drives, total disc storage capacity 2.4 m bytes.

- * Version 4 extended systems monitor on PROM, Vector CP/M 2.2, SCOPE. Screen Oriented Program Editor, full screen dynamic simulating debugger, ZSM Z-80 assembler, Microsoft. BASIC-80 Release 5.



System 3030.

- * Vector-3 console chassis with 12-inch CRT (18" W x 12 1/2" H x 21" D), capacitance keyboard, 6-slot S100 motherboard, and power supply.
- * ZCB Z-80 based single board computer with 1 serial port, 3 parallel ports, 3 PROM slots, and 1K RAM. Flashwriter II Video board, 64K dynamic memory board, floppy disc controller board, Winchester disc interface board, Megastor enclosure with 8-inch Winchester 3-platter hard disc drive, and

2 Micropolis Mod II quad density mini-floppy disc drives (20 1/2" W x 7 1/8" H x 16 3/4" D).

- * Capacity Hard Disc 32 M bytes.
- * 2.5 1/4" MICROP DISC DRIVES giving 630 Kbytes, Storage Capacity.
- * Version 4 extended systems monitor on PROM, Vector CP/M 2.2, SCOPE. Screen Oriented Program Editor, full screen dynamic simulating debugger, ZSM Z-80 assembler, Microsoft BASIC-80 Release 5.

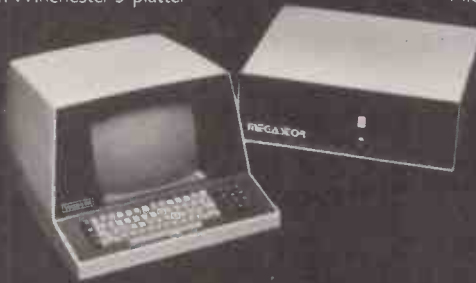

System 'B'

- * 64K Bank Selectable Ram (56K available to user).
- * 3 Serial Ports, 2 Parallel Ports.
- * Twin Disc Drives, 630K Capacity.
- * Z-80 CPU, with Fast 4MHZ Clock.
- * Interrupt Handling on 1/0 Board.

- * 18 Slot Motherboard.
- * Vector Mindless Terminal.
- * Flashwriter II Video Board (24 x 80).
- * CP/M 2.2 Operating System.
- Plus Microsoft Version 5 BASIC SCOPE. Screen Oriented Program Editor, Full screen dynamic simulating debugger, ZSM Z-80 Assembler.



At Almarc Data Systems, when you buy Vector Graphic Micro-Computers, you are assured of Almarc's experience of over 350 systems installed throughout the U.K. — plus their back-up of full service facilities carried out by experienced staff.

Almarc are Specialists in Vector Graphic equipment which includes Micro-Computers for research, laboratory work,

word processing, business systems, schools, colleges, universities and industry. Plus an ever growing list of compatible software including Pascal, Fortran, Cobol, APL, Algol, Basic Compiler and others.

We will be pleased to demonstrate how Almarc + Vector Graphic Systems equates to The Complete Partnership in Micro-Computers.

• Circle No. 262

SUPERBRAIN™

U
P
E

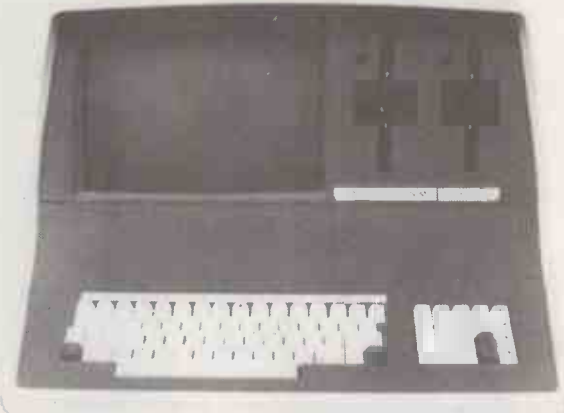

£1495
COMPLETE
+ VAT

FROM

Bonnes Nouvelles Business Systems Ltd

R
A
I

- Dual 4MHz Z80 C.P.U.s.
- Dual double density mini-floppies, (320 Kbytes).
- Dynamically focussed 12" CRT.
- 25 lines by 80 character 8x8in 8x12 field.
- S100 bus via direct connection.
- Dual synchronous/asynchronous RS232 ports.
- CP/M Operating System.
- Single Desk-top unit.
- Wide range of standard software (FORTRAN, COBOL, BASIC, APL, PASCAL). Sales order processing, Invoicing, Sales Ledger, Purchase Ledger, Nominal Ledger, Payroll, Word Star (Word Processing).
- Day 1 maintenance £155.
- Full Client Support.

PHONE Basildon (0268) 411249

Bonnes Nouvelles Business Systems offer a complete service which covers advice, systems design, training and customising of standard software to individual requirements. Specialist services include the supply of low cost Word Processing systems, integrated accounting systems and many other systems at highly competitive prices.

Bonnes Nouvelles is 'GOOD NEWS' ring us and find out.

Bonnes Nouvelles Business Systems Limited
162 Somercotes, Basildon, Essex
Tel: Basildon (0268) 411249

SUPERBRAIN™ is the registered trademark of Intertec Data Systems.

• Circle No. 263

The Acorn modular system

A range and price unmatched by any other manufacturer in the world.
Designed and produced in Britain.

For the absolute beginner...

System One

A compact stand-alone microcomputer based on standard Eurocard modules, and employing the highly popular 6502 MPU (as used in APPLE, PET, KIM, etc). Throughout, the design philosophy has been to provide full expandability, versatility and economy. Many thousands have already been sold throughout the world.

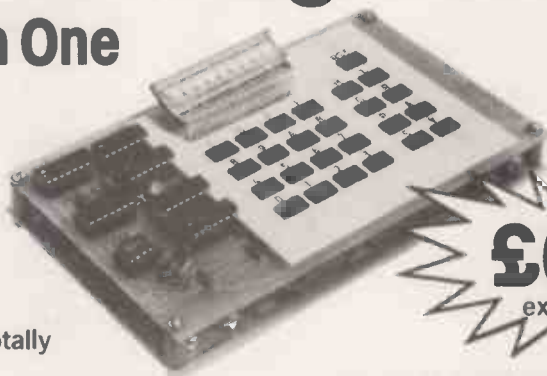

£65 in kit form
excluding VAT

System One is complemented by a range of totally compatible eurocards including:

| | | | |
|---|------|--|--------|
| ● 8K+8K Static RAM and EPROM | £95 | ● Laboratory Interface (isolated inputs, high current outputs) | £122 |
| ● Colour Prestel Compatible VDU Interface | £88 | ● 6809 CPU Card | £98 |
| ● Versatile (serial, parallel, RS232 etc) Interface | £69 | ● Professional Keyboard (parallel ASCII encoded) | £96 |
| ● Dual Mini-floppy Controller | £120 | ● AIM 65 Bus Interface adaptor | £33 |
| ● PROM/EPROM Programmer (Bipolar and UV erasable) | £55 | ● PAL Encoder | £22.50 |
| ● A to D, and D to A Interface (12 bit, high speed) | £132 | | |
| ● Printer Interface (for 12 data 3 strobe) | £60 | | |

All prices exclude VAT

Available soon:

- 80 x 24 character VDU Interface
- 32K Dynamic RAM Card
- 5V/12V Switched mode power supply (1" deep)
- In circuit emulator (block relocating)

- IEEE Bus Interface (Full implementation)
- Real time clock with CMOS RAM

All these cards utilise 'state of the art' devices and represent an elegant and long lasting solution to today's requirements.

...and the absolute professional

System Three



System 3, contains the 6502 CPU, 16K RAM with DOS and BASIC, VDU Interface, Disc controller and 5" drive, Printer Interface, backplane and power supplies. The entire unit costs about £1,000 and can be added to or reformatted as required.

If you need the facilities of the 6809 processor this can be substituted for the 6502 CPU (all other hardware remains unchanged.)

Acorn's fast BASIC combined with what is probably the most efficient disc operating system available may be linked with a control oriented ONLI BASIC addition for laboratory control, or an accounts/stock control package for small businesses.

A twin disc System Four is available if two drives and several peripheral interfaces are required in one case. Full service and software facilities available.

For more information and order form ring or write to

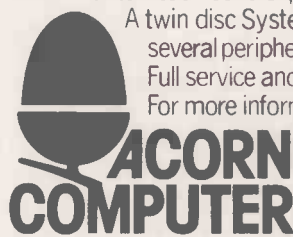

Acorn Computer Limited,
4a Market Hill,
Cambridge, CB2 3NJ
Cambridge (0223) 312772

Please send me further information of Acorn products.

My application concerns _____

Name _____ Address _____

Telephone _____

Acorn Computer Limited, 4a Market Hill, Cambridge, Cambs. Cambridge (0223) 312772

PC/10/80

• Circle No. 264

Z-EIGHTIES

TERODEC

THE IDEAL SYSTEM FOR BUSINESS USE
UNRIVALLED FLEXIBILITY
WIDE RANGE OF CONFIGURATIONS
AVAILABLE
64K RAM STANDARD
4 MHz Z-80 CPUs
1-4 MBYTE 8" FLOPPY DISC STORAGE
FIXED OR CARTRIDGE DISCS
SINGLE OR MULTI USER
TM2-80-1 1 Mbyte **£3995**
TM2-80-2 2 Mbyte **£4295**
TM2-80-3 4 Mbyte **£5595**
DPS 64/1 1 Mbyte **£3099**
DPS 64/2 Mbyte **£3404**

MICROLINE 80

COMPACT AND QUIET
FRICTION & PIN FEED STANDARD
TRACTOR OPTIONAL
PROGRAM SELECTABLE FONTS
GRAPHICS PRINTING
80 AND 132 COLUMNS
6 OR 8 LINES PER INCH
200,000,000 CHARACTER HEAD LIFE
MICROPROCESSOR CONTROLLED INTERFACES
£460

EXIDY

A SUBPERB SMALL SYSTEM FOR BUSINESS
SCIENTIFIC AND EDUCATIONAL USE.
EXCEPTIONAL WORD PROCESSING
CAPABILITY.
UNIQUE DESIGN FEATURES.
STANDARD SYSTEMS — CP/M & S100
MODULAR FOR FLEXIBILITY AND EXPANSION.

| | |
|---------------------|-------------|
| SORCERER 16K | £749 |
| SORCERER 32K | £799 |
| SORCERER 48K | £849 |
| S-100 UNIT | £240 |
| SINGLE DISC 315K | £599 |
| ADD ON DISC 315K | £450 |
| WORD PROCESSING PAC | £120 |

RICOH RP-1600 NEW

ONE OF THE MOST ADVANCED DAISYWHEEL
PRINTERS ON THE WORLD MARKET.
60 CHARACTERS PER SECOND.
UNIQUE WHEEL GIVING UP TO 124
characters.
INTERFACES FOR MOST PRINTERS.
TRACTOR AND SHEET FEED AVAILABLE.

£1595

SOFTWARE

INTERFACE

| | |
|-----------------|-------------|
| PURCHASE LEDGER | £295 |
| SALES LEDGER | £295 |
| NOMINAL LEDGER | £295 |
| PAYROLL | £395 |
| INVENTORY | £395 |

GRAHAM DORIAN

| | |
|-----------------|-------------|
| PURCHASE LEDGER | £500 |
| SALES LEDGER | £500 |
| NOMINAL LEDGER | £500 |
| PAYROLL | £500 |
| DENTAL | £500 |

OSBORNE ASSOCIATES

| | |
|-----------------|-------------|
| PURCHASE LEDGER | £150 |
| SALES LEDGER | £150 |
| NOMINAL LEDGER | £150 |

MANY MORE PROGRAMS AVAILABLE. SEND FOR FULL LIST.

SPECIAL OFFERS

ONE ONLY
CROMENCO 22D 64K
ANADIX DP 8000 PRINTER
ADM3 TERMINAL
EX-DEMONSTRATION
£2500

LIMITED NUMBER
RP-40 DAISYWHEEL PRINTERS
LITTLE USED
£1150

BASIC COMPUTING
OAKWORTH ROAD
KEIGHLEY
W.YORKS BD22 7LA
0535-65094 — MIKE COLLIER

MICROPUTE
9 PRESTBURY ROAD
MACCLESFIELD
CHESHIRE SK10 1AU
0625-612759 — DON COOPER

COLLECT YOUR V.A.T. FROM INFRA LTD.

EPROMS

| | |
|---------|-------|
| 1702A = | 4.25 |
| 2708k = | 5.50 |
| 2716k = | 12.50 |
| 2532k = | 28.50 |

RAMS

| | |
|----------|-------|
| 21141 = | 2.50 |
| 4116-2 = | 3.50 |
| 4118-4 | 19.50 |
| 4334-4 = | 8.50 |

A FEW ITEMS TO INDICATE OUR PRICE-CUT

6502—£8 Z80—£8 6845—£10 6809—£12 SFF96364E—£9 AY5-2376—£9

WHOLE RANGE MORE ON TRADE REQUEST

LS Series

| | | | | | | | |
|--------|-----|---------|------|----------|------|----------|------|
| 74LS00 | .18 | 74LS73 | .33 | 74LS155 | .72 | 74LS245 | 2.50 |
| 74LS01 | .18 | 74LS74 | .30 | 74LS156 | .72 | 74LS247 | 1.09 |
| 74LS02 | .18 | 74LS75 | .40 | 74LS157 | .57 | 74LS248 | 1.09 |
| 74LS03 | .19 | 74LS76 | .27 | 74LS158 | .57 | 74LS249 | 1.09 |
| 74LS04 | .20 | 74LS78 | .27 | 74LS160 | 1.09 | 74LS251 | .96 |
| 74LS05 | .22 | 74LS83 | .78 | 74LS161 | .69 | 74LS253 | .92 |
| 74LS08 | .20 | 74LS85 | .81 | 74LS162 | 1.16 | 74LS257 | .92 |
| 74LS09 | .22 | 74LS86 | .27 | 74LS163 | .69 | 74LS258 | .92 |
| 74LS10 | .20 | 74LS90 | .57 | 74LS164 | 1.06 | 74LS259 | 1.39 |
| 74LS11 | .20 | 74LS91 | .97 | 74LS65 | .72 | 74LS261 | 4.50 |
| 74LS12 | .20 | 74LS92 | .69 | *74LS166 | 1.65 | 74LS266 | .87 |
| 74LS12 | .37 | | | 74LS168 | 1.71 | | |
| 74LS14 | .65 | 74LS93 | .60 | 74LS169 | 1.71 | 74LS273 | 1.70 |
| 74LS15 | .20 | 74LS95 | .81 | 74LS170 | 1.72 | 74LS279 | .57 |
| 74LS20 | .20 | 74LS96 | 1.16 | 74LS173 | .81 | 74LS283 | 1.09 |
| 74LS21 | .20 | 74LS107 | .32 | 74LS174 | .97 | 74LS289 | 4.50 |
| 74LS22 | .20 | 74LS109 | .32 | 74LS175 | .97 | 74LS290 | .91 |
| 74LS26 | .20 | 74LS112 | .32 | 74LS181 | 2.77 | 74LS293 | .91 |
| 74LS27 | .20 | 74LS113 | .32 | *74LS168 | 2.75 | 74LS295 | 1.30 |
| 74LS28 | .22 | 74LS114 | .32 | 74LS189 | 2.08 | 74LS298 | 1.16 |
| 74LS30 | .20 | 74LS122 | .69 | 74LS190 | .86 | *74LS348 | 1.39 |
| 74LS32 | .26 | 74LS123 | .72 | 74LS191 | .86 | 74LS352 | 1.04 |
| | | 74LS124 | 1.39 | | | 74LS353 | .92 |
| 74LS33 | .26 | 74LS125 | .36 | 74LS192 | 1.04 | *74LS362 | 4.21 |
| 74LS37 | .23 | 74LS126 | .36 | 74LS193 | 1.04 | 74LS365 | .56 |
| 74LS38 | .23 | 74LS132 | .60 | *74LS194 | .86 | 74LS366 | .55 |
| 74LS40 | .20 | 74LS133 | .39 | 74LS195 | .97 | 74LS367 | .55 |
| 74LS42 | .65 | 74LS136 | .36 | 74LS196 | .97 | 74LS368 | .55 |
| 74LS47 | .81 | 74LS138 | .65 | 74LS197 | .97 | *74LS373 | .78 |
| 74LS48 | .81 | 74LS139 | .65 | 74LS221 | .92 | 74LS386 | .36 |
| 74LS49 | .81 | 74LS145 | .97 | 74LS240 | 2.08 | *74LS393 | .84 |
| 74LS51 | .18 | 74LS151 | .61 | 74LS241 | 2.08 | *74LS668 | 1.17 |
| 74LS54 | .18 | 74LS153 | .52 | 74LS242 | 2.08 | 74LS670 | 1.71 |
| 74LS55 | .18 | 74LS154 | 1.30 | 74LS243 | 2.08 | | |

INFRA COMPUTER COMPONENTS LTD.

7 WESTFIELD ROAD,
GREAT SHELFORD
CAMBRIDGE CB2 5JW
TEL: 0223-841728

• Circle No. 266

ZILOG MCZ 1/20A

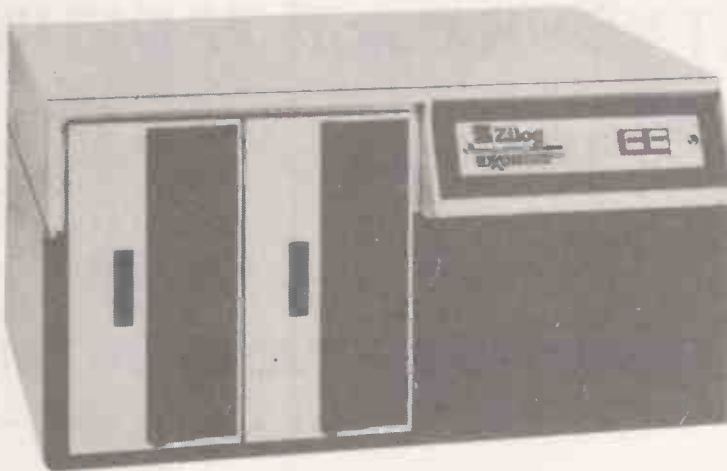

Zilog from Micro-Bits ...your best bet

**Multi-unit buyers, O.E.M.'s sophisticated
end users — the full Zilog product range
is now available through your own distributor.**

The Zilog MCZ range, with its advanced hardware and software options, offers you a high level of flexibility, expandability and sophistication.

SOME TYPICAL SYSTEMS:

MCZ 1/05 computer, 64K, dual 8" disk drives, from around £4,000 or leased for about £138 per month.
MCZ 1/20A computer system, 64K, dual disk drives, VDU and 180 cps printer from £6,025 or leased for about £204 per month.

MCZ 1/35, 64K, 10mb cartridge disk drive. VDU and 180 cps printer from around £12,000 or £408 per month.

APPLICATIONS SOFTWARE:

- ORDER ENTRY/INVOICING
- STOCK CONTROL
- PERSONNEL MANAGEMENT
- WORD PROCESSING
- BILL OF MATERIALS
- INTEGRATED ACCOUNTING
- INFORMATION RETRIEVAL
- BUDGETING/CASH FLOW
- DATABASE MANAGEMENT
- PRODUCTION FORECASTING
- PAYROLL
- STATISTICS
- MAIL LISTS
- LABEL PRINTING
- UNIT COSTING
- INSURANCE BROKERS ACCOUNTS
- BESPOKE SOFTWARE

NEW PRODUCTS

ELBIT VDU with Word*Star oriented keyboard, with special function keys for CURSOR WORD RIGHT & LEFT, SCREEN SCROLL UP & DOWN, HELP, INSERT ON/OFF, DELETE CHARACTER/WORD/LINE, REFORMAT PARAGRAPH, EDIT & END EDIT.

Also available as a separate keyboard package to upgrade your existing VDU.

For further information please contact:



34B London Road, Blacwater. Camberley. Surrey.
Tel: Camberley (0276) 34044. Telex 858893
OFFICES & SHOWROOM. Mon-Fri 9am-6pm.
Sat: by appointment only.

• Circle No. 267

DOLPHIN PRINTERS

From WALTERS MICROSYSTEMS — Britain's leading manufacturer.

Introducing the advanced BD 136 printing at 240 characters per second

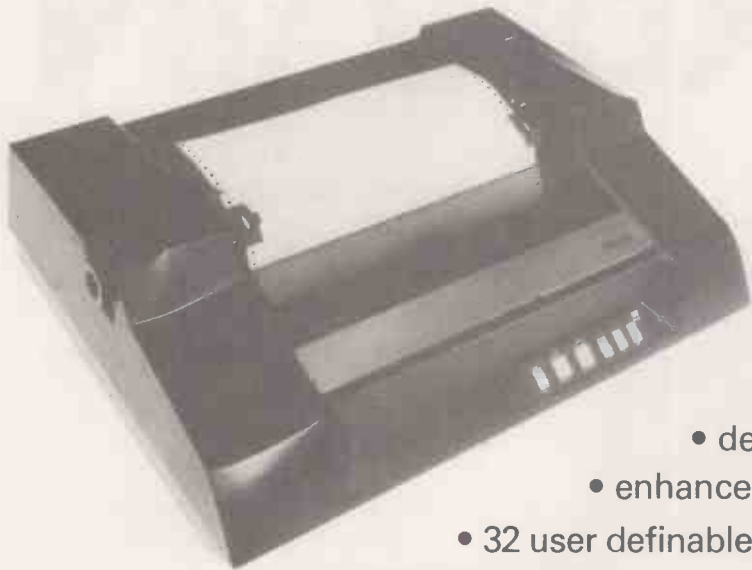

- large 100 line buffer
- centre & right justification
- decimal tab alignment
- enhanced characters
- 32 user definable characters
- £1200.00 end user

& also the BD 80P

- 125 characters per second
- 80/132 characters per line
- 64 graphic characters
- 10 user definable characters
- 750 character buffer standard
- complete with RS 232C, IEEE or parallel interfaces
- £500.00 end user

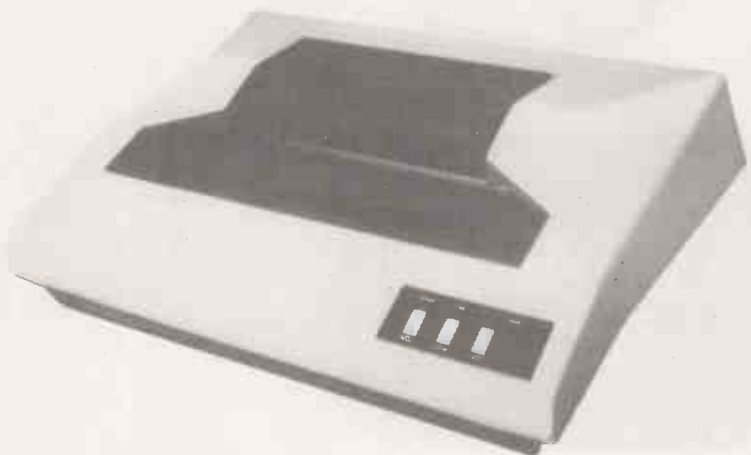

For further information contact the Sales Office
Waters Microsystems,
1, Blenheim Road, Cressex,
High Wycombe,
Buckinghamshire.
Tel (0494) 445172 Telex 837600

• Circle No. 268



Vision Business Systems

FOR YOUR

SUPERBRAIN™



System Specification

- Dual 4MHz Z-80 C.P.U.s
- Dual double-density mini-floppies (320K bytes)
- Dynamically focused 12 inch CRT
- 25 lines by 80 characters
8 × 8 in 8 × 12 field
- Full ASCII keyboard
- S-100 Bus via direct connection
- Dual synchronous/asynchronous RS 232 ports
- CP/M™ operating system
- Single desk top unit
- Day 1 Maintenance £155.00 p.a.

Software Support

- Wide Range of Standard Software — COBOL, BASIC, PASCAL, FORTRAN, APL
- Sophisticated Application Packages — PAYROLL, SALES ORDER PROCESSING, SALES LEDGER, INCOMPLETE RECORDS, nominal ledger.
- WORD STAR — Word Processing Package
- Customised Software Designed To Meet Your Business Needs by Our Specialist Consultants

£1495
COMPLETE
(EX.VAT)

For further information please contact:—
VISION BUSINESS SYSTEMS LTD.,
58 ST. PETER'S STREET,
ST. ALBANS, HERTS.
TEL. ST. ALBANS (0727) 33744

SUPERBRAIN™ is the registered trademark of Intertec Data Systems.

• Circle No. 269

We are now entering our fourth financial year of dealing solely in the personal computer market — in fact, we started it! Over this period, Personal Computers Limited have formed a group of graduate specialists who will help you in the fields of word processing, financial planning, statistics, economic modelling, forecasting, accounting systems, foreign exchange, banking and oil exploration. We also do rather well with computer graphics and highly recommend the graphics tablets and our plotter for Apple.

We can also offer two excellent items of software — **Format 40** and **Visicalc** — at a combined price of **ONLY £189**, and the **Super Sound Generator** for only **£90!** (excl. V.A.T.)



8" Disk Drive (above left)

Our 8" disks are still as popular as ever — 2 drives give you 1.2MB with all the reliable security of Shugart Technology. Easily interfaced to Apple, uses the same D.O.S.

A.I.O. Serial and Parallel Card (above centre)

Three hand-shake lines (R.T.S., C.T.S. and D.C.D.). Firmware for serial interfaces on-board, software for parallel printer available, 2 bi-directional 8 bit parallel ports, plus 4 additional interrupt and hand-shaking lines.

Light Pen (above right)

A much sought after product which we introduced to the U.K.

80 Character Card (below left)

... opens up the real commercial world for all Apple owners.

Paper Tiger (Below centre)

132 character line, plus graphics, 8 character sizes, ordinary paper, multiple copy, upper and lower case 96 character, parallel/serial, form control.

Centronics 730 (Below right)

A substantial, robust printer from a major manufacturer. 3 way paper handling system, 100 character per second. Special low-cost including interface. 96 characters.



Items pictured

Sharp MZ — 80K

A new generation of personal computer, self contained, versatile and starting at only £570 (excl. VAT). Explore the Zilog Z80 now the easy way. Disks and printer available shortly.

Numeric Keypad

... with 8 function keys is a must in all financial applications.

TCM 100 & TCM 200

... both now have graphics as well as their own power supply, essential with this type of printer.

Qume Sprint 5

The quality word processing printer. Clean, clear executive reports the way you want them. Can print up to 5760 points per square inch — or even print in 2 colours.

This is what we do..

and we do it rather well!



For further information, please complete this coupon and post to:
 Personal Computers Limited, 194-200 Bishopsgate, London EC2M 4NR.

NAME _____ ADDRESS _____

PC10

155
 * Now here details for
APPLE III

Personal Computers Limited
 194-200 Bishopsgate, London EC2M 4NR. Tel. 01 626 8121

Quick on the draw!



The Anadex DP-9501 draws high resolution graphics at 5000 dots per second.

The same model doubles as a 220-column alphanumeric printer with: three interfaces as standard (Parallel bit, RS-232C, Current Loop); full communication facility; look-ahead bi-directional printing; 96-character ASCII character set including descenders and underlining of all upper and lower case letters; 200 cps printing speed; 'snap-in' replaceable ribbon cartridge and optional 2.7K buffer store.

All for £995 (one off end user price), available ex-stock.



Anadex Ltd.

Details from Anadex Limited, Dorna House, Guildford Road, West End, Woking, Surrey. Telephone (09905) 6333. Telex 858762 Anadex G.

• Circle No. 271

SUPERBRAIN™

FROM **SUN** THE GROUP WITH A WEALTH
OF HARDWARE & SOFTWARE EXPERIENCE
IN THE COMPUTER INDUSTRY.



NOW WITH

- TWO QUAD-DENSITY FLOPPIES (788K) OR TWO DOUBLE-DENSITY (320K)
- TWIN Z-80A MICROPROCESSORS
- 64K RAM
- CP/M OPERATING SYSTEM
- M BASIC FORTRAN PASCAL COBOL
- UP TO 90 MBYTE HARD DISK OPTION
- WORDSTAR WITH MAILING CAPABILITY
- INTEGRATED BUSINESS PACKAGES

TELEPHONE OR WRITE FOR NAME AND ADDRESS OF YOUR NEAREST DEALER
DEALER ENQUIRIES WELCOME

SUN COMPUTING SERVICES LTD

138 CHALMERS WAY, NORTH FELTHAM TRADING ESTATE,
FELTHAM MIDDX. TEL: 01-751 5044
TELEX: 8954428 SUNCOMG

REMEMBER AS MAJOR DISTRIBUTORS OF INTERTEC PRODUCTS, WE PROVIDE OUR DEALERS WITH

- "NO QUIBBLE" WARRANTY
- FULL SUPPORT SERVICE

COMPETITIVE MAINTENANCE AGREEMENTS; IN-HOUSE SOFTWARE DIVISION

SUPERBRAIN™ is the registered trademark of Intertec Data Systems.

• Circle No. 272



"As manager of Personal Computers, here at Computerland of San Francisco, evaluating new software products is part of my job. With all the word processors on the market today, I choose EasyWriter for my business and personal use."

—Karen Dexter Weiss

EasyWriterTM

80 COLUMNS OF WORD PROCESSING POWER FOR YOUR APPLE II COMPUTER

Finally . . . INFORMATION UNLIMITED SOFTWARE is able to bring you a complete word processing system for the Apple II. The new EasyWriter system gives you **80 columns of upper and lower case characters** for your Apple's video display, using the new SUP'R'TERM 1 board!



You can purchase the new EasyWriter 80 column word processing system from your nearest S.I. Dealer or directly from us

Systematics International Ltd
Essex House, Cherrydown,
Basildon, Essex
(0268) 284601

A long time ago, we decided to bring you the best simple-to-use and understand tools for your computer system. Today we've taken another stride in that same direction. It took some doing, in both hardware and software, but we think you'll agree that for the buck, no one can touch us.

Check it out:

- 80 Columns on the Screen!
- Upper & Lower Case!
- Global Search & Replace!
- Underlining!
- Bidirectional Printing!
- Incremental Spacing!
- File Appending!
- 50 Pages of Text Per Disk!



Sole UK Distributors

- EasyWriter is a TM of Cap'n Software, Inc.
- Apple II is a TM of Apple Computers, Inc.

Practical Computing Back Issues

Each month, *Practical Computing* carries at least one hands-on test of a popular microcomputer for use in business, the home, schools and colleges. Each issue contains the kind of information you need — technical data and for the intelligent professional layman, unbiased critical comment on the strengths and weaknesses of each system or service reviewed.

All this makes *Practical Computing* an invaluable source of whys, wherefores, hows, ifs and buts of microcomputing.

Order your back issues now, by simply filling in our Back Numbers order form bound in every issue.

October 1978 *
Review 1: Commodore Pet I **Review 2:** VDUs — Computer Workshop Ct-64, Strumtech Engineering ACT-1, Music on a KIM; Micro v Calculator, VAT accounting complete program Part 1.

November 1978 *
Review: Tandy TRS-80. Projects for KIM: Pet goes to school; VAT accounting complete program Part 2; Complete game program — Mastermind; Software Dynamics Basic compiler review.

December 1978 *
Review: Research Machines 380Z. Choosing your first computer; ITT interview; Complete games programs — Battleships, Racing Cars and Monsters; A microcomputerised reservation system.

January 1979
Review: Nascom I Convert an IBM typewriter into a terminal Part I; In-car computing — Pet in the Panther DeVille; Report from the Los Angeles Computer Faire; Pascal v Basic.

February 1979
Reviews: Cromemco Z-2D. Low-cost peripherals. Systems for estate agents and doctors; A £1000 payroll system; IBM typewriter conversion Part 2; Complete game program — Warlock Warren.

March 1979
Review: Single-board computers for less than £50 Low-cost stock-control systems; IBM typewriter conversion Part 3; New monthly column — Tandy Forum; Complete game program — NIM.

April 1979 *
Review: North Star Horizon Business accounting systems; Apple II design story Part 1; Computerised school meals; Finance for school computing; Build your own frequency meter; Star Trek game.

May 1979
Reviews: Exidy Sorcerer, Science of Cambridge Mk 14; Printers for less than £1000; Order processing/invoicing packages; Retire with your computer; Apple II design story Part 2; Slalom game.

June 1979
Reviews: Compucolor II, Ohio Superboard II; Low-cost word-processing; Computing in a pharmacy; Designing a small business application Part 1; Computer v. Brain; Zombie game.

July 1979 *
Reviews: AIM-65, SOL-20. Choosing your first computer; Interfacing Pet with a mainframe; Nascom story; Designing a small business application Part 2; Biorhythms program.

August 1979
Reviews: Pet II KIM, Pros and Cost of PASCAL Microcomputer user groups; Designing a small business application Part 3; Interfacing Pet with a mainframe Part 2; Life game program.

September 1979 *
Reviews: Powerhouse 2, Acord Anadex and Heathkit printers Artificial intelligence; Build your own joystick; Computer scene in the North-West; Mathematics on a Pet; Self-teaching games program.

October 1979
Reviews: Designing a small business application Part 4; Apple II and Tandy; Build your own sports scoreboard; Inside Speak & Spell; Introduction to LISP; Inside Presail



September 1979

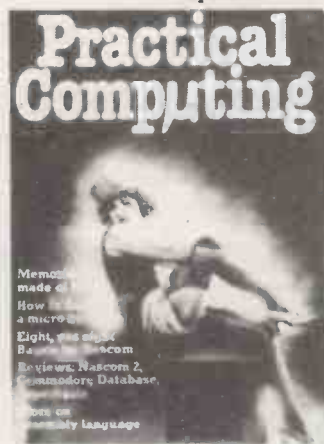

April 1980



August 1980



January 1980



July 1980



September 1980

November 1979
Reviews: Rair Black Box; ECS Teletext computer; Computer for the amateur; Learning program for the self-testing chip; Financial modelling

December 1979
Reviews: Transam Teletext for Apple and ITT 2020. Conversion program for Apple II. How to set up computer systems in schools. Tips for Sorcerer users. File handling techniques.

January 1980
Reviews: Hewlett Packard HP-41C TEI systems. Eurapple — What's in store for 1980. Computer graphics. Using a micro to measure pain responses. Getting started with micros.

February 1980
Reviews: Minimax. Add-on machine code chip for Pet. Video Game; Personal computer networks; Multi computer electronics and miniaturisation; Blatant Medusa; Simulated battle game; Model building; Robotics Part 1; Continuing the series: Micro in antique business; How to write better programs; High speed stepper motors and the Pet.

March 1980
Reviews: Tandy TRS-80 model II, M8T System 7; Training schemes for programmers; Copyright Law and software; Update program; Showdown game for Pet; Robotics Part 2; The Game Master, three page celebration of games playing; Assembly language series part 1, machine code; Hardware Buyers' Guide.

April 1980
Reviews: Nascom single board Superbrain. Commodore database; Video game made for this, latest in storage; How to raise cash for your own micro business; Eight Basics for Nascom; LA video link for London; Software Buyers' Guide.

May 1980
Reviews: Z-Plus UK-101; Intelligent gambling, how the micro might forecast the results; Videotex and the micro; The good software is expensive; Cobol assembly language part 3; New monthly column — 6502 Special. COS for Apple II. Hardware Buyers' Guide.

June 1980 *
Reviews: Panasonic JD-700U. VisiCalc. The electronic newsagent, newstrade applications; Latest developments in viewdata systems; Social services and micro applications; Electric motors as computer-controlled servo mechanisms; New monthly column — Sorcerer's Apprentice; COS for Apple II part 2. Software Buyers' Guide.

July 1980
Reviews: Sharp PC-1211; Sinclair ZX-80; Payroll-200; Tuscan design story — Birth of a system, Part 1; Apple II game; The story of a man and his back room computer; A car game; CPM explained; Cheap hard copy for Nascom 1; Hardware Buyers' Guide.

August 1980
Reviews: Texas Instruments TI99/4; Rair, hard-disc system; Computech sales ledger; Tuscan designer's story part two. Games; Adventure II and Superbank part two; a listing of user groups; MUSE software standards. This and much more including the Software Buyers' Guide.

September 1980
Reviews: Motorola Exorset; Ohio Scientific Challenger; Anagram stock control; Tuscan design story Part III; Personal money management; Naspen word processor; Shape table compiler for Apple II and ITT2020 Special Peripherals Buyers' Guide.

Fill in the coupon opposite and return it with your remittance to *Practical Computing*, General Sales Dept, Room CP34, Dorset House, Stamford Street, London SE1 9LU. Please note that back issues can be ordered only on the current order form.

* Limited Stocks

TANGERINE — British Computer Kits — TUSCAN

Microtan 65 Kit £69.00
Tanex (min. config.) £43.00
Tanex expanded kit £106.00
Key pad/full ASCII
keyboard, P.S. Mother
board, cabinets etc.

Single Bd. excl. Video,
Kit £195.00
Single Bd. incl. Video,
Kit £235.00
Also available, full ASCII
keyboard, P.S. cabinet,
mini floppies etc.

BOOKS

| | | |
|------|-------------------------------|--------|
| Ref. | | |
| 200 | Prog. the Z80 — ZAKS | £8.95 |
| 60 | Prog. the 6502 — ZAKS | £7.95 |
| 40 | BASIC BASIC — Coan | £6.50 |
| 159 | Z80 Ass. Lang. Leventhal | £8.15 |
| 233 | Computer Technicians Handbook | £7.25 |
| 150 | Computer Progs. that Work | £3.95 |
| 169 | Microsoft BASIC | £6.75 |
| 187 | 6502 Ass. Lang. Leventhal | £8.25 |
| 65 | BASIC Computer Games | £5.50 |
| 195 | The BASIC Handbook | £11.00 |
| 171 | BASIC & the Personal Computer | £9.75 |
| 62 | The Best of Byte | £8.75 |
| 203 | Best of Micro Vol. 1. (6502) | £5.50 |
| 204 | Best of Micro Vol. 2. (6502) | £6.50 |

| | | |
|------|---|--------|
| Ref. | | |
| 212 | Crash course in Micros | £10.65 |
| 167 | How to make money with your Micro-computer | £5.75 |
| 36 | Instant BASIC | £7.20 |
| 216 | Intro to Micros for Ham Shack | £3.95 |
| 184 | Little Bk. of Basic Style | £5.75 |
| 161 | More BASIC Comptr. Games | £5.50 |
| 24 | TTL Cookbook | £7.15 |
| 224 | BASIC Cookbook | £3.95 |
| 226 | Beginners Guide to Computers and Micros | £5.00 |
| 237 | How to design, and build your own working computer system | £5.75 |
| 243 | Microprocessor Cookbook | £4.64 |
| 246 | Modern Digital communications | £5.95 |
| 247 | Modern Guide to Digital Logic | £5.75 |

Other books available, why not send for list.
V.A.T. extra (where applicable) Post and Packing extra.

MICRO-PRINT LTD.

21 Bankhouse Road, Hanford, Stoke on Trent ST4 8EN 0782-657893

Note: New retail premises: from 1st. October 1980 —
59 Church Street, Stoke on Trent. 0782-48348

• Circle No. 274

**FULL RANGE OF
BUSINESS
SYSTEMS
AVAILABLE
PRICES FROM
£2500**



apple computer
Sales and Service



Q-COM ELECTRONICS LTD
5TH FLOOR, ST. MARTINS HOUSE
10 BULL RING
BIRMINGHAM B5
021-643 3540

NORTHERN BRANCH:—
STAND 220 BURNLEY (0282) 25723

• Circle No. 275

THE PROOF IS IN THE PRINTOUT

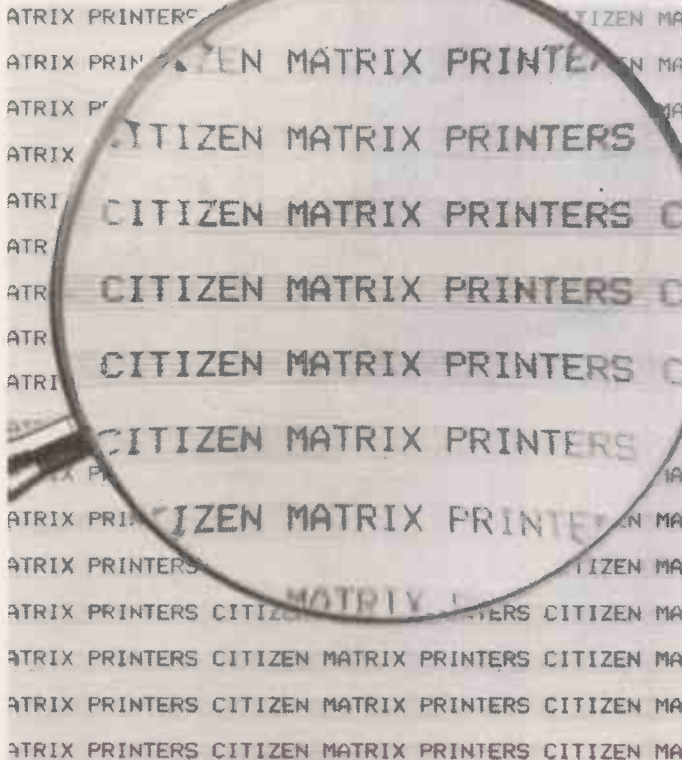

Seeing is believing. Take a closer look at the Citizen Dot Matrix printout and you'll see its superb quality. Watch the machine in action and you'll appreciate its versatility at the highest levels of performance.

The range features:—

- 120 or 180 character per second models.
- 9 x 9 matrix head giving true descenders.
- expanded and condensed print.
- variable paper width to 17".
- 8 bit parallel or RS232C interfaces.
- dot graphics option.
- variable form length.

Engineered with the reliability you'd expect from a precision watch manufacturer, Citizen Printers are immediately available and fully supported by the nationwide service of the OEM Division of DRG Business Machines, Lynx Crescent, Winterstoke Road, Weston-super-Mare, Avon BS24 9DN. (Tel: 0934 415398).

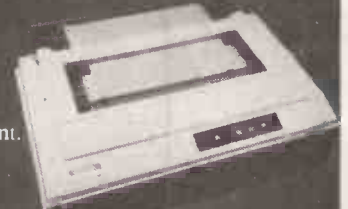

DRG Business Machines

A Dickenson Robinson Group Company

Please send me an actual printout and more information about Citizen Printers. Please contact me.

Name _____ Position _____

Company _____

Address _____

Type of Business _____ Tel: _____

TALK TO DRG ABOUT CITIZEN PRINTERS

• Circle No. 276

We specialise in big help for buyers of small systems.

Lots of people feel they need help when it comes to choosing and buying a business computer.

That's why they come to NSC Computer Shops.

We are specialists and we have the most experience. So we can give the most expert advice.

We also offer the widest range you could wish to see.

Plus a total back-up including consultancy, software and continuing support. And you get a good deal, price-wise.



Pet

A popular and very reliable small business system used for accounting, word processing, mailing lists and other office tasks. NSC's attractive prices on all models of the Pet make it a very sound investment.

South West Technical Products

A middle priced business computer widely used for word processing, and a big time saver on things like mailing lists. NSC have stocks of disc drives, both 8" and 5¼" and memory boards and interface cards, with reductions of up to 40% on some items. Also available are processor cards to upgrade to 6809, and a complete range of 6809 equipment.



North Star Horizon

A complete word processing system extendible from 32K-56K RAM, up to four mini disc drives, 4MHz Z80A processor, serial and parallel I/O ports and extended BASIC. NSC have a full range of accounting packages available for this system, which has also proved very popular in educational and industrial applications. You can lease it over a five year period for as little as £25 per week.

Apple

Manchester's first Apple dealer. We will be pleased to demonstrate any of the exciting products which are now available with the Apple, including voice recognition, graphics tablet etc.

Cromemco

Top quality computer systems backed by complete software service for word and data processing. The only microcomputer currently available with RPG II.

Centronic 779 for £779

The most robust low cost printer around. At a special reduced price of £779 while stocks last.

Acorn Atom

Come and try this new budget priced computer at NSC Computer Shops. Kit machine available from £120.

Shop at NSC and get a better deal.

Ring 061-832 2269 for further information.

NSC COMPUTER SHOPS

Here to help

NSC Computer Shops, 29 Hanging Ditch, Manchester M4 3ES

THE SOFTWARE WORKSHOP

SYSTEMS AND PROGRAMS FOR APPLE & ITT COMPUTERS.

PAYROLL MASTER

THE FIRST OF A NEW BREED OF COMPUTER PROGRAMS FOR THE PROFESSIONALS.
CONTAINS ALL THE FEATURES YOU EXPECT FROM A PAYROLL SYSTEM AND MANY MORE:—

- ALL TAX AND NATIONAL INSURANCE CALCULATIONS CARRIED OUT AUTOMATICALLY
- 4 HOURLY RATES OF PAY — OVERTIME RATES — LUMP SUM PAYMENTS MADE AUTOMATICALLY — 5 ADJUSTMENTS BEFORE TAX — 5 ADJUSTMENTS AFTER TAX
- WEEKLY, MONTHLY AND TWO WEEKLY PAYROLL.
- PENSIONS CALCULATED AUTOMATICALLY. (WHEN REQUIRED)
- MOST TYPES OF BONUS CALCULATIONS AND PAYMENTS CATERED FOR.
- EASY TO READ PAYSLEIPS WHICH SHOWS YOUR COMPANY NAME.
- PASSWORD.
- PERFECTED AND TESTED BY EXPERIENCED EMPLOYERS AND OFFICE STAFF.
- SOFTWARE INSURANCE PLAN. (RENEWABLE ANNUALLY):— THIS ENSURES THAT WHEN YOU NEED HELP YOU GET IT. ALSO INCLUDES FREE UPDATE DISKS WHEN THE TAX AND NATIONAL INSURANCE RATES CHANGE. (REGARDLESS OF THE NUMBER OF CHANGES)
- EXCELLENT DOCUMENTATION.
- MANY MORE FEATURES.

PRICES

| | |
|------------------------------------|---------|
| PAYROLL MASTER. (INCLUDING MANUAL) | £200.00 |
| SOFTWARE INSURANCE PLAN (1st YEAR) | £70.00 |
| PAYSLEIPS (PER THOUSAND) | £19.50 |

APPLE DOC

SURCHARGES FOR STRINGS/VARIABLES TO LIST, REPLACE ETC
— LIST LINES THAT ARE DEPENDANT ON OTHER LINES
MANY MORE FEATURES — GOOD DOCUMENTATION

£24.95

DISK UTILITY

REPORTS ON THE NUMBER OF FREE SECTORS ON A DISK
— DISK ERRORS ETC — SPECIAL COPY PROGRAM.
MANY MORE FEATURES — GOOD DOCUMENTATION

£20.00

PLEASE CONTACT US FOR FURTHER DETAILS

TELEPHONE NUMBER: 0704 43038

70 SUSSEX ROAD
SOUTHPORT
MERSEYSIDE PR9 0SP

ALL PRICES EXCLUDING V.A.T.

• Circle No. 278

MULTI USER MICRO SYSTEM!

NO IT'S NOT A JOKE, IT'S A REALITY! IT'S CALLED MVT-FAMOS, AND IT'S UP AND RUNNING ON OUR IMS 8000 RANGE AT THIS VERY MOMENT

That's right, it's not 'Coming Shortly', it's not 'Available in the near future', and it's certainly not 'Soon to be released'. It's available now, and we can demonstrate it at your convenience.

MVT-FAMOS is a full multi-user, multi-tasking operating system, which means that you can have several terminals running many different types of systems, such as stock control, accounting and payroll, all at the same time. Or you may wish to have several people all accessing the same system, MVT-FAMOS doesn't mind, it's entirely up to you.

You don't have to spend a lot of money to get started with FAMOS either, a 2 drive floppy based system with 64K of RAM storage, VDU and printer sells for as little as £7,000. But once you start there's no stopping, because you can increase the number of terminals, the amount of RAM memory, and even add multiple hard disk drives, giving you millions of bytes of data storage.

So if you would like to arrange for a demonstration of this extremely advanced and versatile system, or even just to set some more information, contact:—

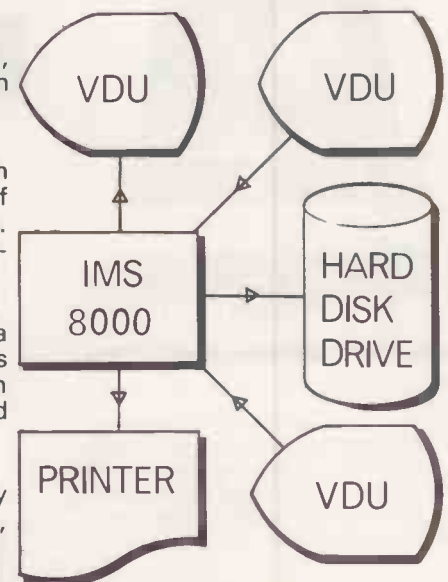

MICROTEK COMPUTER SERVICES

50 Chislehurst Road, Orpington, Kent, BR5 0DJ. Tel: Orpington 26803

• Circle No. 279

NEW THE TUSCAN S100

A Z80 based S100 Computer System.

TUSCAN main board. The heart of the system with Z80, video, Ram, Rom, and I/O plus five S100 slots for expansion.

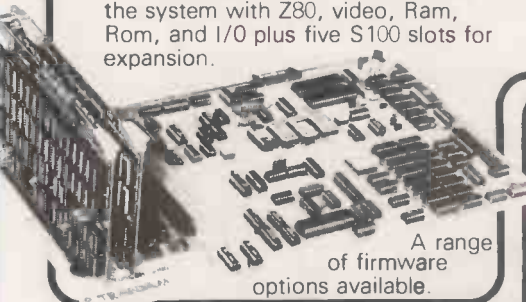

A range of firmware options available.

Available in Kit Form or Assembled.

All components available separately.

Houses two 5 1/4" drives for a compact business system

Professional case will house the complete system

Two keyboard options

Hinged lid for easy access.

Stylish finish ideal for office or home.

On Demonstration NOW

KITS from £195 + VAT delivery Ex-Stock

nascom-2

MICRO-KIT COMPUTER

FREE 16k B RAM Board
FREE POWER SUPPLY

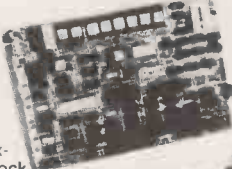

Ex-stock

only £335

+ VAT
Full after sales service

Firmware & MOS ICs

Zeap Assembler (4, 1Kx8 EPROMS) £50
Nas Pen text editor (2, 1Kx8 EPROMS) £30

Expansion boards (in kit form)

16K RAM £127.50 • 32K RAM £175.00

48K RAM £220.00

High Resolution Programmable Graphics £90

Colour Board Kit £140

High Resolution Colour add on £37.50

NASCOM PRODUCT LIST + VAT

| | |
|---|-----------------|
| I/O board kit less I/O chips | 45.00 |
| UART + BAUD rate generator + crystal for I/O board | 16.00 |
| Econographics kit for additional 128 characters (N1 only) | 30.00 |
| 2708/2716 Programmer suitable for N1 and N2 under NAS-SYS | £20.95 plus VAT |
| Nascom 19" rack mounting card frame for N1 and N2 | 32.50 |
| Nas-DA disassembler 3 EPROM for Nas-sys | 37.50 |
| MK36271 8K BASIC in 8K x 8 ROM | 40.00 |
| Naspen VS in 2 EPROM | 30.00 |
| Nas-sys monitor in 2 EPROM | 25.00 |
| Nasbug T2 1 x EPROM | 12.50 |
| Nasbug T4 2 x EPROM | 25.00 |
| Tiny Basic 2 x EPROM | 25.00 |
| Super Tiny Basic 3 x EPROM | 37.50 |
| Super Tiny Basic upgrade 1 x EPROM | 12.50 |
| Tape Software | |
| ZEAP 2 tape and documentation for Nas-sys | 30.00 |
| 8K BASIC tape and documentation for N1 | 15.00 |

THE HENELEC DISK SYSTEM

FOR NASCOM and any other Z80 - 8080 Microcomputer with an uncommitted P10



• The Henelec controller card plugs direct into a Z80 P10 and controls up to 3 double-sided mini-floppy drives giving a maximum 480K system.

• General Purpose FDC control software for simple DOS or for CPM.

• Simple DOS software for NASCOM 1/2 under NAS-SYS

• OR ROM CB10S for CPM on NASCOM 1/2 incorporating the major NAS-SYS features. Maximum 60K CPM system.

• New MD gram supplied for N2/CPM

TWO SYSTEMS

• SIM-DOS "Floppy Tape Recorder" with 1 drive PSU firmware, etc. £335 plus VAT

• CPM System with 1 drive PSU firmware, etc. £395 plus VAT

• Additional Drives with PSU £235 plus VAT

COMPUTER KEYBOARDS



71 KEY ASCII KEYBOARD INCLUDING NUMERIC KEYPAD. £49.00 plus £7.35 VAT TOTAL £56.35. Uses gold crosspoint keys. Includes keypad and ribbon cable. Only available as fully assembled and tested.

STAR DEVICES MK III 71 keytouch sensitive keyboard. With numeric pad. All ASCII characters including control keys. Auto key repeat. Parallel output with strobe. Shift lock with indicator LED. Built in 'beeper' with level control. 5V DC at 300mA 15" x 7" x 1.25". Grey case with white keys on blue. 48.50 plus VAT

CARTER 57 key ASCII keyboard. Conventional keyboard. 128 ASCII characters including control keys. Parallel output with strobe. Shift lock. + 5 V and -12 V DC. 12" x 5.5" x 1.5". Black keys with white legends. 39.34 + VAT.

FERRANTI - "SIZE 14 x 6 x 3" SLOPING FRONT" 55 Key ASCII Coded in steel case. Complete with Plug and Cable with circuit to convert to T.T.L. levels. In good condition at only £25 + VAT, P/P £2.50

TANGERINE

COMPUTER SYSTEMS

"MICRON"

the latest line in superb products on demonstration from your London stockist

EX-STOCK

£375.00 inc. VAT
BRITISH DESIGN

- 6502 based microcomputer
- VDU alpha numeric display
- Powerful monitor TANBUG
- 8K RAM
- 32 parallel I/O lines
- 2 serial I/O lines
- RS 232 C/20mA loop, with 16 programmable Baud rates
- Four 16 Bit counter timers
- CUTS cassette recorder interface
- Data bus buffering
- Memory mapping control
- 71 Key ASCII Keyboard, including numeric keypad and with auto repeat
- Including metal cabinets for both keyboard and modules
- Including power supply
- 10K Microsoft BASIC

Ideal for NASCOM - PET - TRS80 - TRITON

NASCOM IMP



PLAIN PAPER £325 PRINTER

Fully built and housed in a stylish enclosure for just £325 plus VAT.

INTERFACES WITH ALL MICRO COMPUTERS

The Nascom IMP (Impact Matrix Printer) features are

- 60 lines per minute. 80 characters per line.
 - Bi-directional printing. • 10 line print buffer.
 - Automatic CR/LF. 96 character ASCII set (including upper/lower case, \$, £). • Accepts 8 1/2" paper (pressure feed). • Accepts 9 1/2" paper (tractor feed). • Tractor/pressure feed. Baud rate from 110 to 9600. • External signal for optional synchronisation of baud rate.
- IDEAL FOR WORD PROCESSING

CENTRONICS QUICK PRINTER

List Price £459 incl. VAT



OUR PRICE plus VAT £195

EXCLUSIVE TO HENRY'S 50% OFF MAKER'S PRICE

for: Software selectable 20, 40 and 80 column using 120mm aluminium-jessed paper. 1 roll supplied. 150 lines per minute. NASCOM Centronics parallel data interface for Nascom, Tandy, etc. 240 volt mains input. ASCII character set Paper feed, and on/off select switches 'BELL' signal. Weight 10lbs Size: 13" x 10 1/2" x 4 1/2". New, boxed and fully guaranteed POST PAID Price £195.00 + VAT See COMPUTING TODAY Recommendations MARCH/MAY ISSUES

MEMORIES Discounts 10% for 4, 15% for 8, 20% for 16

| | | | |
|------------------------|-------|------------------------|-------|
| MK3880 (NZ80) | 7.50 | 2708 | 6.95 |
| MK3880-N4 (Z80A) | 7.95 | 2716 | 17.95 |
| MK4116 16K x 1 dy RAM | 6.50 | IM6402 UART | 4.50 |
| MK4027 4K x 1 dy RAM | 2.25 | 2114 1K x 4 Static RAM | 3.25 |
| 2102 1K x 1 static RAM | 1.00 | 8080A | 5.25 |
| 4118 1K x 8 static RAM | 12.75 | | |

SEND FOR COMPLETE COMPUTER BROCHURE FREEPOST TO ADDRESS BELOW

London Tangerine and TUSCAN NASCOM DISTRIBUTOR
Export Orders deduct VAT, but add 5% carriage
Official Export & Educational Orders welcome
Our Telex 262284 Mono Ref. 1400 Transonics

ADD VAT 15% TO YOUR ORDER EXCEPT WHERE STATED



TANGERINE LONDON STOCKISTS

Microtan 65 Kit, Incl. VAT £79.35
Microtan 65 Assembled, £90.85

Tanex (min. con) Kit, Incl. VAT £49.45
Tanex Assembled Incl. VAT £60.95
Lower case pack, Incl. VAT £10.90
Chunky Graphics Pack, Incl. VAT £7.50
20 Way Keypad Incl. VAT £11.50
Mini-mother board Incl. VAT £9.95
Complete Tangerine range available

HENRY'S

Computer Kit Division
404 Edgware Road, London, W2, England I.E.D.
01-402 6822



• Circle No. 280

WORDWRIGHT

Powerful word processing package: screen editing, formatting, section headers automatically included in contents page; automatic letter formatter for less than perfect typists. All British. For Z80 CP/M disc systems.

SPELLING CORRECTION as you type too — version for 8" discs includes **CORRECTOR** — see below.

SAE for brochure; Manual £20, system without **CORRECTOR** £150; with **CORRECTOR** £350.

PILOT

Interpreted **PILOT** language for writing Computer assisted learning programs. Supports numerical and string arrays and stack operations. **PILOT** is the perfect language for writing Adventures . . .

SAE for brochure; £5 for manual; £85 for disc.

SPELLING MITSAKES?

CORRECTOR is the world's first program for micros to detect and correct spelling mistakes.

- 25,000 word dictionary from Oxford University Press.
- Space for 20,000 user-definable words — good for industries or sciences with a technical vocabulary.
- **CORRECTOR** needs Z80 CP/M with 8" discs. — and a text editor.
- Send SAE for brochure, £5 for manual, £150 for disc and manual.

SOUTHDATA LTD 221 Portobello Road, London W11.

• Circle No. 281



Some new introductions by the Midlands Computer Centre...

We celebrate our first birthday with news of new introductions available from the Micro Computer Centre.

NEW

HORIZON

NEW

CROMEMCO

NEW

(As soon as available)

NEUBRAIN

In addition to Nascom and Commodore micro computers

PERIPHERALS

(Excluding printers)

Sharp Cassette Decks. Crofton 10" Cased Monitors.

PRINTERS

Nexos Ricoh RP 1600 Daisy Wheel Printer. Diablo Daisy Wheel Printer. Nascom Micro Imp, Dot Matrix Plain Paper Printer. Centronics Dot Matrix. Anadex Dot Matrix. Newbury Laboratories Dot Matrix Impact Printer.

ADD-ONS FOR NASCOM

Input/Output Board. PIO Kit. Counter Timer Kit. UART Kit. (Colour Board Programmable Character Generator Board. Floppy Disc System (Single Drive) available in September). Nas-Pen Text editor. ZEAP 2.0 in EPROM or on Tape. Nas-Sys 3 Enhanced version of Nas-Sys 1. Nas-Dis - Disassembler. Debug - Dynamic Debugger.

BITS & PCs

Tool Kit. Port Probe. Hex Key Pad.

WILLIAM STUART

Colour Graphics for Nascom 1 & 2.

MERSEYSIDE NASCOM USER GROUP

ROM/EPROM Board for Nasbus.

EXTRAS

Henry's EPROM Burner. Antex Soldering Irons & Bits.

SOFTWARE

Northstar. CAP-CPP. Cromemco. Petsoft. Supersoft. Nascom Games.

BOOKS

Very full range of books on 6502, Z80, Languages, Interfacing. Introductory books and games and General Programs.

MAGAZINES

Personal Computer World. Computing Today. Practical Computing. Educational Computing. Liverpool Software Gazette. Printout.

ASK ABOUT THE KENILWORTH CASE

The "Kenilworth" Case. Microtype Case. Veroframe.

BUSINESS & LEISURE MICROCOMPUTERS

Castle Interface.

Business & Leisure Micro Computers

16 The Square, Kenilworth, Warwickshire CV8 1EB. Tel: (0926) 512127

• Circle No. 282

Now available On Earth



THE SHARP MZ-80 COMPUTER SYSTEM

Sharp have been associated with many major advances in electronic technology in space and here on Earth. We have introduced the most sophisticated production techniques for electronic circuitry to set world renowned standards of reliability into every product.

That's why the MZ-80K and its range of peripherals is going to change the way you think about microcomputers. The Sharp MZ-80 System now includes the MZ-80K processor backed with the MZ-80FD dual drive, double sided mini-floppy disk unit to give rapid, effective, sequential and random access, to huge amounts of stored information with incredibly fast response times.

Our new MZ-80P3 printer makes a good impression as well. Its fine definition dot matrix

head prints across 80 columns, at 100 characters per second, with full graphics capabilities.

The Sharp MZ-80 System is a new approach to computer applications, and their efficient use by human beings.

Our aim is to make computers and their related equipment relatively simple and therefore better understood and better used by those they are designed to serve.

Whether you are looking for a business system, or a system for educational or personal use—take a look at Sharp, it will change the way you think about computers.



COMPUTER APPLICATIONS

Send me details of the complete Sharp MZ-80 System and the name and address of my nearest stockist

PC10

Name _____

Address _____

Sharp Electronics (UK) Limited, Sharp House, Thorp Road, Newton Heath, Manchester. M10 9BE Tel: 061-205 2333

• Circle No. 283

the choice was ours... ...now its yours

RICOH R.P. 1600 Daisy Wheel Printer

- 1 letter quality**
- 2 speed 60 C.P.S.**
- 3 economy**

- **Printing speed - 60 C.P.S.**
- 124 character print wheel
- Integral PET Interface
- Line width - 136 characters (10 characters per inch)
- 163 characters (12 characters per inch)

**Complete word processing systems -
PET, Wordcraft, R.P. 1600 also available**

Price R.P. 1600 £1590 inc PET Interface



small systems engineering limited

2-4 Canfield Place · London · NW6 3BT · Telephone 01-328 7145/6 Telex: 88130Q5 (Abacus)

ANADEX D.P. 9500/01 Line Printer

- 1 speed 150-200 C.P.S.**
- 2 matrix flexibility**
- 3 economy**

- Bi-directional printing with shortest distance sensing logic
- High density graphics
- 50 to 200 + Lines/Min. 150/200 CPS with 9 x 9/7 x 9 Character font or 120/200 CPS with 11 x 9/7 x 9 Character font
- 132/158/176 or 132/165/198/200 Columns
- Parallel, RS-232-C and Current Loop Interfaces standard. PET Interfaces available.

**Prices: 9500 - £895
9501 - £995**

• Circle No. 284

RICOH A printer for all systems

THE RP-40

This printer has a well established record of use in large systems throughout the country. Over a period of several years, it has earned an outstanding reputation for its exceptional quality and reliability.

THE RP-1600

The new RP-1600 is one of the most advanced daisywheel printers on the world market. It has been developed to meet both present and future needs of word processors, computer terminals and mini-computer systems. The unique double wheel, with its 124 character set, is the key to its superb performance. It allows an impressive speed of 60 characters per second and maintains excellent print quality.

APPLICATIONS

Ricoh printers are versatile. They are equally well suited to printing continuous large volumes of data, and to producing top quality word processed letters.

Microprocessor control of carriage movements down to 1/120 inch make them capable of bidirectional printing, proportional spacing, graph plotting, etc.

Through our selection of interfaces they can be connected directly to RS-232, Centronics, IEEE, etc — which means almost any small computers.

And they cost from as little as £1450.

We will be pleased to send you a sample printout and further details of the range of options available, and to quote for the printer to suit your own requirements.

For further details of the full range of Ricoh printers, please contact:—

**Don Cooper
MICROPUTE
FREEPOST
MACCLESFIELD
CHESHIRE
SK10 1YE
Tel: 0625-612759**

**Mike Collier
BASIC COMPUTING
OAKWORTH ROAD
KEIGHLEY
WEST YORKSHIRE
BD22 7LA
Tel: 0535-65094**

• Circle No. 285

COMPUTECH for



COMPUTECH for

ITT

Well proven software (several hundred packages already licensed) for business applications on the ITT 2020 and Apple microcomputers.

Prices excluding V.A.T for cash with order, F.O.B London NW3

| | | |
|-----------------------------|--|------|
| PAYROLL | (300+ Employees, 100 Departments, hourly, weekly, monthly. Very powerful but easy to use). | £375 |
| SALES LEDGER | (500+ Accounts, 100 Departments). | £295 |
| PURCHASES LEDGER | (500+ Accounts, 100 Departments). | £295 |
| GENERAL (OR NOMINAL) LEDGER | (1000 Accounts, 100 Analyses, multi-purpose package). | £295 |
| UTILITIES DISK 1 | (Diskette patch, slot to slot copy, zap etc). | £20 |
| APPLEWRITER | (Word Processing) | £42 |
| VISICALC | (Financial Modelling, Costing, Analysis) | £95 |

AND NOW HARDWARE!

COMPUTECH DIPLOMAT H/S SERIAL INTERFACE £80

This card has been designed and built to the same professional standards that have resulted in the success of our software. The DIPLOMAT observes the proper "handshaking" protocol so that you can drive fast printers and send and receive data from other peripherals at high speeds without loss of data. Switch (& software) selectable baud rates to 19200 and many other options. Plug compatible with 'terminal' or 'modem' wired peripherals. Guaranteed.

MICROLINE M80 PRINTER £450

This neat, reliable machine prints at 10 characters per inch, 80 characters on an 8 inch line, or 40 expanded characters, or 132 very readable characters, upper and lower case and graphics, 9 x 7 dot matrix, 6 or 8 lines per inch. Parallel interface is standard, serial optional. Both friction and sprocket feed are standard, tractor optional. We can also supply the parallel interface card for Apple System computers for £80 and a driver to enable both text and graphics to be used. Optional custom colour matching for Apple or ITT.

THE FABULOUS MICROMUX 8000 from £800

This is a brand new product, an asynchronous serial multiplexor with up to 16 ports, any one of which may communicate with any other independently, like a 'telephone exchange' for data! Built in test function. Firmware may be customised for special applications. Available in multiples of 4 ports up to 16.

COMPUTECH SYSTEMS

168, Finchley Road, London NW3 6HP. Tel: 01-794 0202

AGENTS THROUGHOUT THE UK AND OVERSEAS

• Circle No. 286

PETE + PAM COMPUTERS
(PETE + PAM FISHER)
MAILORDER APPLESARE
BY REPUTABLE COMPANIES
AT FAIR PRICES
MICROSOFT

Z-80 SOFTCARD — 175.00

At Last! A card that runs software written for Z-80 based systems, on APPLE. Inc. CP/M system. Compatible with Lans. Card and all peripherals.

TYPING TUTOR — 7.95

Now you can turn your APPLE into the Aristotle of Typing Tutors! Requires 16K + APPLESOFT. (Cassette)

ADVENTURE — 14.95

For the first time, the original uncut ADVENTURE fully implemented on a personal computer (32K disk)

MHR ENTERPRISES

SUP-R-TERM — 189.95

The best of the 80 Column Video Cards. Check out the rest and then try this. Inc. shift-lock mod. 80*24 lines. 128 U + L case 5*8 dot ASCII chr set.

HIGH TECHNOLOGY INC.

DATA BASE MANAGEMENT SYSTEM — 49.95

The one you've seen elsewhere in this mag. for between 100.00 and 205.00! We offer it at a FAIR price. Sort, search, print large amounts of data in the way you want. The best price you'll find.

INFORMATION MASTER — 69.95

Store information then let INFORMATION MASTER do the work: Organizing Sorting Searching Selecting Alphabetizing Scheduling Indexing Calculating Multiplication Division Addition Subtraction Exponentiation Summation Reporting Paging Labeling Cataloging Summarizing Totaling Subtotaling.

CHARLES MANN & ASSOCIATES

MASTER TEXT PROCESSOR — 69.95

Includes Mailing list and Form letter elements. Floating text. One of the best. Sold 1,000 so far.

STATISTICS PAC — 45.95

Inc. data management system. Curve fitting Probability Gen. stats Distribution Maths Test stats. Uses High Res. graphics. Req. 32K + disk.

TEACHER PLUS — TAPE 13.95 DISK 17.95

Applesoft teaching program. Supports all major programming capabilities. Req. 16K tape 32K disk.

FLOATING POINT DICTIONARY — DISK 18.95

Ask the program for an explanation of any term in the language and it will respond with a definition working examples of the statement form you may use, and a test program you may run to see the results of the commands use. Inc. a HELP command.

PLUS TEACHING PAC — DISK 29.95

A combination of Teacher Plus and F.P. dictionary.

PERSONAL SECRETARY PACKAGE — TAPE 31.95 DISK 34.95

Keep track of phone numbers, filed records and appointments. Developed around a major bank concept to improve efficiency.

PROFESSIONAL SEC. PACKAGE — TAPE 43.95 DISK 46.95

Designed to service the professional who requires effective use of his/her billable time. Keep track of a years appointments, client phone numbers and case files. Has a unique time management element to keep track of billable time automatically as work is done and provides an end of day record by client and task.

PLEASE ADD 15% VAT.

FREE POSTAGE AND PACKING

WE WANT TO BE YOUR MAILORDER

SUPPLIER. IF YOU KNOW WHAT YOU WANT

— AND DON'T WANT TO PAY AN INFLATED

PRICE — GIVE US A CALL. WE'LL TRY OUR

BEST!

TEL 01-677 2052 (24HRS)

SEVEN DAYS A WEEK

98 MOYSER ROAD

LONDON SW16 6SH

• Circle No. 287

interface components

EXPAND YOUR NASCOM WITH OUR NASBUS COMPATIBLE EPROM BOARD. ONLY £55*

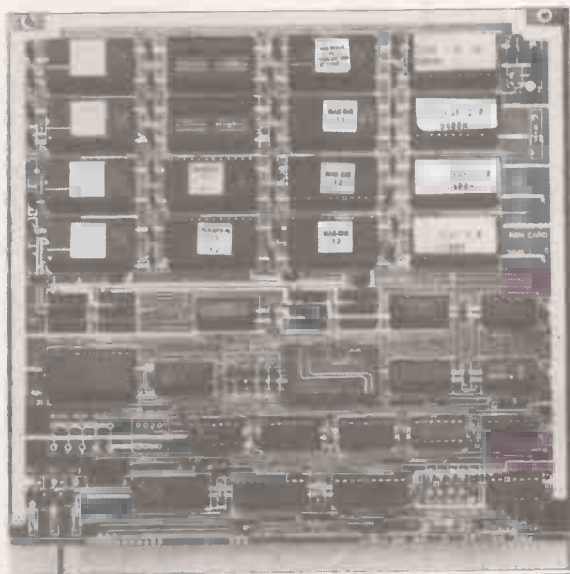

Every Nascom 1 and 2 user can now expand their machine with up to 32K of EPROM.

Our NASBUS compatible EPROM board has 16 sockets to take 2708s or 2716s, organised in four banks of four. And as long as each bank has the same EPROMs, you can mix the banks between 2708 and 2716. Furthermore, each bank can be decoded to start at any 4K address boundary.

Just think, you can plug in the NAS-PEN text editor, ZEAP assembler, NAS-DIS disassembler and NAS-DEBUG, and still have 6 spare sockets.

The board also has a 24 pin, 8K ROM socket addressable on any 4K boundary. Ideal for Nascom 1 owners to add the 8K BASIC to their system.

For the benefit of Nascom 2 users, we have fitted the board with a wait-state option. When selected, this facility is automatically activated while the board is being addressed and allows you to use your microprocessor at 4MHz with slower EPROMs.

We could have stopped there, but we decided to make our EPROM board the most comprehensive available. Which is why our board can support the Nascom Page Mode Scheme.

The board can be switch selected to any one of four pages enabling it to be used in conjunction with up to three of the new Nascom RAM boards of any memory capacity.

Like Nascom's own expansion boards the Interface Components EPROM board is an 8" x 8" silk screened, solder resist board manufactured to the full NASBUS specification and therefore totally compatible with other NASBUS boards.

*£55 plus VAT+ £1.00 P & P

INTERFACE COMPONENTS LIMITED,
OAKFIELD CORNER, SYCAMORE ROAD, AMERSHAM, BUCKS HP6 6SU
TELEPHONE: 02403 22307. TELEX: 837788

Write, telephone or call. Access or Barclaycard accepted

• Circle No. 288

It's faster and more thorough than classroom learning: you pace yourself and answer questions on each new aspect as you go. This gives rare satisfaction - you know that you are really learning and without mindless drudgery. With a good self-instruction course you become your own best teacher.

Understand Digital Electronics

In the years ahead digital electronics will play an increasing part in your life. Calculators and digital watches mushroomed in the 1970's - soon we will have digital car instrumentation, cash cards, TV messages from friends and electronic mail.

After completing these books you will have broadened your career prospects and increased your knowledge of the fast-changing world around you.

DIGITAL COMPUTER LOGIC AND ELECTRONICS £7.00

This course is designed as an introduction to digital electronics and is written at a pace that suits the raw beginner. No mathematical knowledge is assumed other than the use of simple arithmetic and decimals and no electronic knowledge is expected at all. The course moves painstakingly through all the basic concepts of digital electronics in a simple and concise fashion: questions and answers on every page make sure that the points are understood.

Everyone can learn from it - students, engineers, hobbyists, housewives, scientists. Its four A4 volumes consist of:

- Book 1 Binary, octal and decimal number systems; conversion between number systems; conversion of fractions; octal-decimal conversion tables.
- Book 2 AND, OR gates; inverters; NOR and NAND gates; truth tables; introduction to Boolean algebra.
- Book 3 Positive ECL; De Morgans Laws; designing logic circuits using NOR gates; dual-input gates.
- Book 4 Introduction to pulse driven circuits; R-S and J-K flip flops; binary counters; shift registers; half-adders.

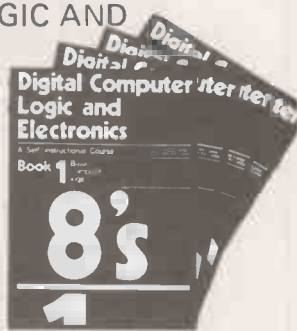

DESIGN OF DIGITAL SYSTEMS £12.50

This course takes the reader to real proficiency. Written in a similar question and answer style to Digital Computer Logic and Electronics, this course moves at a much faster pace and goes into the subject in greater depth. Ideally suited for scientists or engineers wanting to know more about digital electronics, its six A4 volumes lead step by step through number systems and Boolean algebra to memories, counters and arithmetic circuits and finally to an understanding of calculator and computer design.

- Book 1 Octal, hexadecimal and binary number systems; conversion between number systems; representation of negative numbers; complementary systems; binary multiplication and division.
- Book 2 OR and AND functions; logic gates; NOT, exclusive-OR, NAND, NOR and exclusive-NOR functions; multiple input gates; truth tables; De Morgans Laws; canonical forms; logic conventions; Karnaugh mapping; three state and wired logic.
- Book 3 Half adders and full adders; subtractors; serial and parallel adders; processors and arithmetic logic units (ALUs); multiplication and division systems.
- Book 4 Flip flops; shift registers; asynchronous and synchronous counters; ring, Johnson and exclusive-OR feedback counters; random access memories (RAMs) and read only memories (ROMs).
- Book 5 Structure of calculators: keyboard encoding; decoding display data; register systems; control unit; program ROM; address decoding; instruction sets; instruction decoding; control programme structure.
- Book 6 Central processing unit (CPU); memory organization; character representation; program storage; address modes; input/output systems; program interrupts; interrupt priorities; programming; assemblers; computers; executive programs; operating systems and time sharing.



Flow Charts and Algorithms

are the essential logical procedures used in all computer programming and mastering them is the key to success here as well as being a priceless tool in all administrative areas - presenting safety regulations, government legislation, office procedures etc.

THE ALGORITHM WRITER'S GUIDE £4.00

explains how to define questions, put them in the best order and draw the flow chart, with numerous examples.

GUARANTEE No risk to you.

If you are not completely satisfied, your money will be refunded upon return of the books in good condition.

CAMBRIDGE LEARNING LIMITED, UNIT 45
RIVERMILL SITE, FREEPOST, ST. IVES, HUNTINGDON,
CAMBS., PE17 4BR, ENGLAND.
TELEPHONE: ST. IVES (0480) 67446

All prices include worldwide postage (airmail is extra - please ask for prepayment invoice).
Please allow 28 days for delivery in U.K.

Microcomputers are coming - ride the wave! Learn to program.

Millions of jobs are threatened but millions more will be created. Learn BASIC - the language of the small computer and the most easy-to-learn computer language in widespread use. Teach yourself with a course which takes you from complete ignorance step-by-step to real proficiency with a unique style of graded hints. In 60 straightforward lessons you will learn the five essentials of programming: problem definition, flowcharting, coding the program, debugging, clear documentation. Harder problems are provided with a series of hints so you never sit glassy-eyed with your mind a blank. You soon learn to tackle really tough tasks such as programs for graphs, cost estimates, compound interest and computer games.

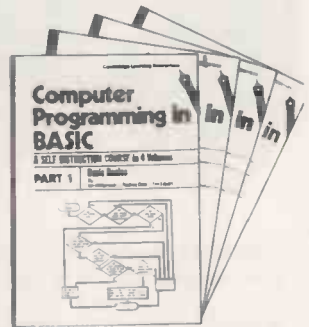

COMPUTER PROGRAMMING IN BASIC £9.00

- Book 1 Computers and what they do well; READ, DATA, PRINT, powers, brackets, variable names; LET; errors; coding simple programs.
- Book 2 High and low level languages; flowcharting; functions; REM and documentation; INPUT, IF...THEN, GO TO; limitations of computers, problem definition.
- Book 3 Compilers and interpreters; loops, FOR...NEXT, RESTORE; debugging; arrays; bubble sorting; TAB.
- Book 4 Advanced BASIC; subroutines; string variables; files; complex programming; examples; glossary.

THE BASIC HANDBOOK £11.50

This best-selling American title usefully supplements our BASIC course with an alphabetical guide to the many variations that occur in BASIC terminology. The dozens of BASIC 'dialects' in use today mean programmers often need to translate instructions so that they can be RUN on their system. The BASIC Handbook is clear, easy to use and should save hours of your time and computer time. A must for all users of BASIC throughout the world.

A.N.S. COBOL £4.40

The indispensable guide to the world's No. 1 business language. After 25 hours with this course, one beginner took a consulting job, documenting oil company programs and did invaluable work from the first day. Need we say more?

ORDER FORM

Please send me the following books:-

- Digital Computer Logic & Electronics @ £7.00
- Design of Digital Systems @ £12.50
- Algorithm Writer's Guide @ £4.00
- Computer Programming in BASIC @ £9.00
- BASIC Handbook @ £11.50
- ANS COBOL @ £4.40
- Your Booklist (Free)

I enclose a *cheque/PO payable to Cambridge Learning Ltd.
for £..... (*delete where applicable)

Please charge my:

* Access/American Express/Barclaycard/Diners Club/Eurocard/Visa/
Mastercharge/Trustcard

Credit Card No.

Signature

Telephone orders from credit card holders accepted on 0480 67446 (AnsaFone).

Overseas customers (incl. Eire) should send a bank draft in sterling drawn on a London bank, or quote credit card number.

Name

Address

Cambridge Learning Limited, Unit 45, Rivermill Site,
FREEPOST, St. Ives, Huntingdon, Cambs PE17 4BR, England.
(Registered in England, No. 1328762)

• Circle No. 289

Erase Eproms in 8 minutes for under £100

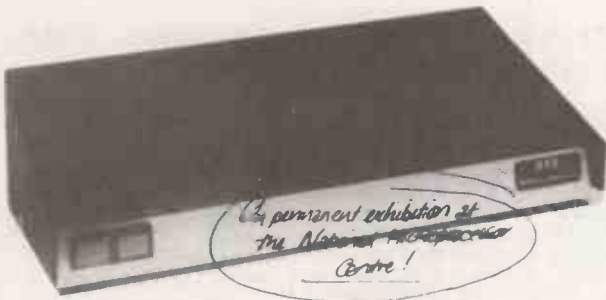

The high speed, high capacity model UV8 sets new performance and price standards.

- Cuts typical erasure times by a factor of
- 8 MINUTE SOLID STATE TIMER
- Capacity up to 14 EPROMS
- 2708 type erased in 4 to 7 minutes
- High intensity 254 NM UV source
- Safety interlock automatically starts timing sequence
- Audio tone signals erasure cycle complete
- Internal switch to extend erase time.

MICRODATA Computers Ltd, Belvedere Works, Bilton Way, Pump Lane Industrial Estate, Hayes, Middlesex.

Telephone (01) 848 9871 (6 lines) Telex 934110

BUBBLE MEMORY and REAL TIME CLOCK for NASCOM



The 8423 is fully assembled, burnt in and plugs into the 77 way NASBUS.

- Add a non-volatile memory to your NASCOM I or II.
- Monitor transparent — use it with NAS-SYS, T2, T4 or B-BUG.
- Unaffected by dust or vibration.
- 92,304 bit capacity organised as 144 minor loops of 641 bits.
- Battery supported chime clock generates perpetual day, date, time.
- Dealers enquiries welcomed.

MICRODATA COMPUTERS LTD
BELVEDERE WORKS, BILTON WAY,
PUMP LANE INDUSTRIAL ESTATE, HAYES,
MIDDLESEX UB3 3ND

Telephone (01)-848 9871 (6 lines) Telex 934110

• Circle No. 290

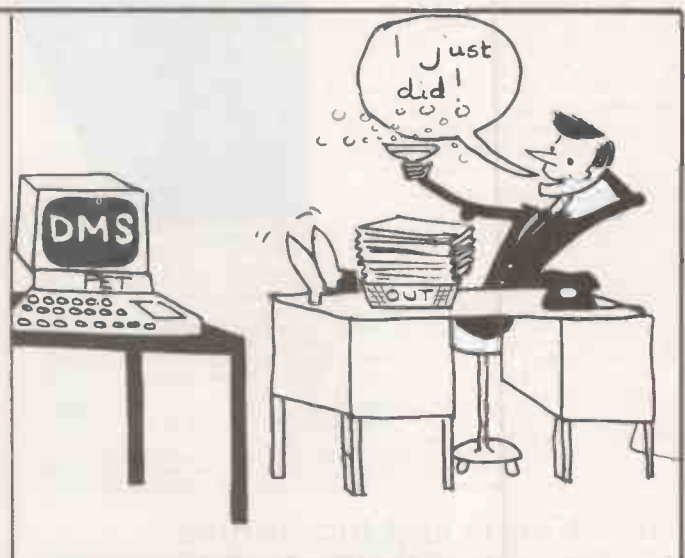

RECORD KEEPING MADE SIMPLE ON THE 32K DISK BASED PET.

- Stores information
- Updates records
- Searches
- Prints and sorts reports
- Prints labels
- Easy to use: no programming knowledge needed

●●● DOES ANY CALCULATIONS e.g. VAT, SALES FIGURES, INVENTORY VALUES, PRICE INCREASES, etc, etc, etc.

A unique program; original and best. Over 200 sold in UK alone.

Available from Comsoft, Old Manor Lane, Chilworth, Surrey. Tel. Guildford (0483) 39665 and Geneva (022) 574834 and Commodore in Hong Kong and Canada, and from PET dealers nationwide.

EXISTING USERS: PLEASE REGISTER WITH COMSOFT IMMEDIATELY FOR A COMPLIMENTARY COPY OF OUR NEW VERSION.

Soon available on CP/M.

• Circle No. 291

CP/M COMPATIBLE SOFTWARE FROM SUPERSOFT

System Maintenance

Diagnostics 1 — easily the most comprehensive set of CP/M compatible system check-out programs ever assembled. Finds hardware errors in your system, confirms suspicions or gives the green light. Tests:

- * MEMORY
- * CPU (8080/8085/Z80)
- * TERMINAL
- * DISK
- * PRINTER

The CPU test is the first of its kind to our knowledge. It pays to find problems before they become serious. Minimal requirements 24K CP/11. Supplied complete with User Manual £39.95, manual alone £9.95.

Software Security

Encode/Decode is a complete software security system for CP/M, a sophisticated coding program package which transforms data stored on disk into completely unrecognisable coded text. Encode/Decode supports multiple security levels and passwords, and a user defined combination (from the billion possible) is used to code and decode a file. Uses are unlimited, and DATA BASES, PAYROLL FILES, PROGRAMS, GENERAL LEDGER, CORRESPONDENCE, TAX RECORDS, INVENTORY, ACCOUNTS PAY/REC and MAILING LISTS are just a few of the applications possible. Encode/Decode I provides a level of security for normal use. £39.95 complete with User Manual. Manual alone £9.95. Encode/Decode II provides enhanced security for the most demanding needs. £79.95 complete with User Manual, Manual alone £9.95. Both versions come supplied on discette.

MICROCHIPS AT MICRO PRICES!

LOW PROFILE SOCKETS BY TEXAS SALE

| | | | | | |
|--------|-----|--------|-----|--------|-----|
| 8 pin | 7p | 18 pin | 15p | 24 pin | 22p |
| 14 pin | 9p | 20 pin | 18p | 28 pin | 25p |
| 16 pin | 10p | 22 pin | 22p | 40 pin | 28p |

DIL SWITCHES

| | |
|---------|------|
| 4 pole | 99p |
| 6 pole | 115p |
| 8 pole | 140p |
| 10 pole | 175p |

74LS

| | | | |
|--------|-----|---------|------|
| 74LS00 | 18p | 74LS151 | 75p |
| 74LS01 | 12p | 74LS153 | 75p |
| 74LS04 | 15p | 74LS155 | 65p |
| 74LS08 | 20p | 74LS161 | 78p |
| 74LS10 | 19p | 74LS163 | 90p |
| 74LS11 | 30p | 74LS164 | 90p |
| 74LS12 | 30p | 74LS168 | 190p |
| 74LS14 | 60p | 74LS174 | 99p |
| 74LS15 | 38p | 74LS175 | 99p |
| 74LS20 | 19p | 74LS195 | 87p |
| 74LS32 | 25p | 74LS221 | 110p |
| 74LS40 | 26p | 74LS244 | 175p |
| 74LS42 | 56p | 74LS245 | 325p |
| 74LS47 | 78p | 74LS251 | 120p |
| 74LS48 | 85p | 74LS257 | 110p |
| 74LS49 | 99p | 74LS290 | 95p |
| | | 74LS293 | 120p |
| | | 74LS366 | 57p |
| | | 74LS373 | 170p |
| | | 74LS374 | 170p |
| | | 74LS375 | 140p |
| | | 74LS377 | 188p |
| | | 74LS393 | 135p |
| | | 74LS490 | 140p |
| | | 74LS670 | 260p |

| | | |
|---------|-----|-----------|
| 74LS73 | 30p | INTERFACE |
| 74LS74 | 30p | LINEAR |
| 74LS75 | 39p | MC1488 |
| 74LS86 | 39p | MC1489 |
| 74LS90 | 40p | DM8123 |
| 74LS107 | 40p | 75150 |
| 74LS123 | 69p | 75154 |
| 74LS125 | 50p | 75182 |
| 74LS132 | 79p | 75322 |
| 74LS138 | 69p | 75324 |

| | |
|--------|-----|
| 24 pin | 22p |
| 28 pin | 25p |
| 40 pin | 28p |

| | |
|------------|-------|
| Z80A DMA | 2495p |
| Z80 S10/1 | 2995p |
| Z80A S10/0 | 3495p |
| Z80 S10/1 | 2995p |
| Z80A S10/1 | 3495p |
| Z80 S10/2 | 2995p |
| Z80A S10/2 | 3495p |

SUPPORT DEVICES

| | |
|-------------|-------|
| 6520 | 495p |
| 6522 | 795p |
| 6532 | 895p |
| 6551 | 1095p |
| 6810 | 375p |
| 6820 | 425p |
| 6821 | 425p |
| 6850 | 425p |
| 6852 | 425p |
| 8212 | 395p |
| 8214 | 450p |
| 8216 | 395p |
| 8224 | 395p |
| 8228 | 395p |
| 8251 | 495p |
| 8253 | 1125p |
| 8255 | 495p |
| 8257 | 1050p |
| 8259 | 1325p |
| MC 144 12VL | 797p |
| Z80 P10 | 595p |
| Z80 CTC | 595p |
| Z80A P10 | 695p |
| Z80A CTC | 695p |
| Z80 DMA | 1995p |

KEYBOARD ENCODER

| | |
|-----------|------|
| AY-5-2376 | 795p |
|-----------|------|

UARTS

| | |
|------------|------|
| AY-5-1013A | 325p |
| AY-3-1015D | 398p |
| IM6402 IPL | 425p |

CHARACTER GENERATOR

| | |
|--------------|------|
| RO-3-2513 UC | 450p |
|--------------|------|

DEVELOPMENT MODULE

| | |
|----------|-------|
| Z8000 DM | £1099 |
|----------|-------|

BIPOLAR PROMS

| | |
|---------------------|--------|
| 93448 518 x 8 40 NS | p.o.a. |
| 93453 1k x 4 40 NS | p.o.a. |
| 93451 1k x 8 45 NS | p.o.a. |
| 93511 2k x 8 50 NS | p.o.a. |

FLOPPY DISK CONTROLLERS

| | |
|--|-------|
| FD1771 B-01 S/D Inverted Bus | 2995p |
| FD1791 B-01 D/D Inverted Bus | 4995p |
| FD1792 B-01 S/D Inverted Bus | 3495p |
| FD1793 B-01 D/D True Bus | 5495p |
| FD1794 B-01 S/D True Bus | 3495p |
| FD1795 B D/D Inverted Bus, side select | 5995p |
| FD1797 B D/D True Bus, side select | 5995p |

MEMORIES

| | |
|--------------------|------|
| 2114 300 NS | 275p |
| 4116 200 NS | 300p |
| 4116 150 NS | 395p |
| 4315 (4k x 1) CMOS | 995p |
| RAM 450 NS | 995p |
| 6514 (1k x 4) CMOS | 795p |
| RAM 450 NS | 795p |

EPROMS

| | |
|----------------|-------|
| 1702A | 450p |
| 2708 450 NS | 425p |
| 2716 5V 450 NS | 850p |
| 253232K450NS | 2995p |

CPU'S

| | |
|---------|--------|
| 6502 | 795p |
| 6504 | 795p |
| 6505 | 795p |
| 6800 | 695p |
| 6802 | 995p |
| 8080A | 525p |
| 8085A | 1095p |
| Z80 | 795p |
| Z80A | 995p |
| Z8001 | 12500p |
| X8002 | 9500p |
| WD9000B | 19900p |

THE NEW GI COMPUTER SOUND CHIP

The amazing AY-3-8910 is a fantastically powerful sound and music generator, perfect for use with any 8-bit micro processor. Contains 3 tone channels, noise generator, 3 channels of amplitude controls, 16-bit envelope period control, 2 parallel I/O, 3D/A converters plus much more. All in 40 pin DIP. Super easy to interface to the S-100 or other Buses. ONLY £8.50 + VAT, including FREE reprint of BYTE '79 article! Also, add £2.25 for 60-page data manual. "Perhaps the next famous composer will not direct a 150-piece orchestra but, rather, a trio of micro-computers controlling a bank of AY-3-8910s." BYTE July '79.

NEW! STEREO!

S100 SOUND COMPUTER BOARD!
At last, an S-100 Board that unleashes the full power of two unbelievable General Instruments AY-3-8910 NMOS Computer sound IC's. Allows you under total computer control to generate an infinite number of special sound effects for games or any other program. Sounds can be called in BASIC, ASSEMBLY LANGUAGE etc.
KIT FEATURES
*Two GI Sound computer IC's (AY-3-8910)
*Four parallel I/O ports on Board
*Uses on Board audio Amps or your STEREO
*On Board proto typing area
*All sockets, parts and hardware are included
*PC Board is soldermasked, silk screened with gold contacts
*Easy, quick and fun to build, with full instructions
*Uses Programmed I/O for maximum system flexibility
*Both BASIC and ASSEMBLY language programming examples are included
COMPLETE KIT ... ONLY £59.96 includes 60 page data Manual
BARE BOARD ... ONLY £25.00 includes 60 page data Manual
AY-3-8910 chip special price with purchase of BARE BOARD (2 chips) £15.00

SOFTWARE

SCL is now available! Our Sound Command Language makes writing Sound Effects programs a SNAP! SCL also includes routines for Register-Examine-Modify, Memory-Examine-Modify and Play-Memory. SCL is available on CP/M compatible diskette or 2708/2716. Diskette — £19.95, 2708 — £14.95, 2716 — £24.95. Diskette includes the source. EPROMS are ORG at E000H.
ONLY £7.95! (8 for £50)
The TIC 5514P from Toshiba, CMOS equivalent of the 2114!
* Lower Power Dissipation
 .10pW/BIT (TYP.) at 3.0V (STANDBY)
 .10uW/BIT (TYP.) at 5.0V (OPERATING)
* Data Retention Voltage 2V to 5.5V
* Single 5V Power Supply
* 18 PIN Plastic Package
* Full Static Operation
* Three State Output
* Input/Output TTL Compatible
* Fast Access Time 450NS.
Toshiba's TC5514P (industry type 6514) is a full static read write memory organised as 1024 words by 4 bits using CMOS technology. Ultra low power dissipation means it can be used as battery-operated portable memory system and also as a non-volatile memory with battery back-up. Operates from a single 5V power supply with static operation, hence no refresh periods and a much simplified power supply circuit design. Three state outputs simplify memory expansion for minimum data retention voltage is 2V, the battery back-up system needs only simple circuit. Toshiba's original C2MOS technology also means wide operating and noise margins. The TC 5514P is moulded in a dual-in-line 18 pin plastic package 0.3 inch in width.

Ordering information. Unless otherwise stated, for orders under £50 add 50p p&p. Add 15% VAT to total (no VAT on books). All devices are brand new, factory prime and full spec and subject to prior sales and availability. Prices subject to change without notice. Minimum telephone order using ACCESS is £10. If ordering by post with ACCESS, include name, address and card no. written clearly. Please allow 4/6 weeks delivery on books.
Unit 9/10, 1st Floor, E Block, Dept. PC2, 38 Mount Pleasant, London WC1X 0AP Tel: 01-278 7369 Telex: 895 3084

BOOKS

Please order books by reference no. and title, and add 50p post & packing for each book ordered.

| | |
|---|--------|
| 21168 Active Filter Cookbook | £10.95 |
| 21440 Aviation Electronics 3rd Ed. | £ 6.75 |
| 21558 Audio IC Op Amp Applications 2nd Ed. | £ 5.95 |
| 21586 Basic Programming Primer | £ 6.50 |
| 21554 Boolean Algebra for Computer Logic | £ 4.50 |
| 21447 The 8080A Bugbook-Microcomputer Interfacing & Programming | £ 7.75 |
| 21465 Building & Installing Electronic Intrusion Alarms | £ 3.95 |
| 21524 The Cheap Video Cookbook | £ 4.50 |
| 21398 CMOS Cookbook | £ 7.75 |
| 21652 Computer Dictionary 3rd Ed. | £ 8.95 |
| 21650 Computer Graphics Primer NEW! | £ 7.50 |
| 21693 Scientists & Engineers 3rd Ed. NEW | £11.95 |
| 21697 8085A Cookbook NEW! | £ 7.50 |
| 21539 Design of Active Filters with Experiments | £ 5.95 |
| 21536 DEBUG: An 8080 Interpretive Debugger | £ 3.75 |
| 21537 Design of Op Amp Circuits with Experiments | £ 5.95 |
| 21545 The Design of Phased-Locked Loop Circuits with Experiments | £ 6.75 |
| 21686 Design of VMOS Circuits with Experiments NEW! | £ 5.95 |
| 21618 Electronic Telephone Projects | £ 4.95 |
| 21351 How to Buy and Use Minicomputers and Microcomputers | £ 7.50 |
| 21684 How to program and interface the 6800 NEW! | £10.50 |
| 21459 How to Program Microcomputers | £ 6.75 |
| 21127 How to Read Schematic Diagrams 3rd Ed. | £ 4.25 |
| 21613 How to Use Integrated Circuits Logic Elements 3rd Ed. | £ 4.50 |
| 21634 HWS Crash Course in Microcomputers NEW! | £13.25 |
| 21527 IC Converter Cookbook | £10.50 |
| 21695 IC Op Amp Cookbook 2nd Ed. | £11.25 |
| 21416 IC Timer Cookbook | £ 8.50 |
| 21546 Interfacing & Scientific Data Communications and Experiments | £ 4.50 |
| 21550 Introductory Experiments in Digital Electronics and 8080A Microcomputer Programming and Interfacing, Book 1 | £ 9.95 |
| 21551 Introductory Experiments in Digital Electronics and 8080A Microcomputer Programming and Interfacing, Book 2 | £ 8.25 |

| | |
|---|--------|
| 21601 Instrumentation: Transducers and Applications | £ 8.95 |
| 21452 Learn Electronics Thru Troubleshooting 2nd Ed. | £ 8.25 |
| 21694 LC Circuits | £ 4.46 |
| 21542 Logic and Memory Experiments Using TTL Integrated Circuits — Book 1 | £ 7.50 |
| 21543 Logic and Memory Experiments Using TTL Integrated Circuits — Book 2 | £ 7.50 |
| 21568 Linear IC Principles, Experiments and Projects 2nd Ed. | £ 7.50 |
| 21540 Microcomputer-Analog Converter Software and Hardware Interfacing | £ 7.25 |
| 21583 Microcomputer for Business Applications | £ 6.75 |
| 21614 Microcomputer Interfacing with the 8255 PPI Chip | £ 6.75 |
| 21653 Microcomputer Primer 2nd Ed. | £ 8.95 |
| 21612 Oscilloscope, Applications & Experiments | £ 6.75 |
| 21635 99 Practical Electronics Project 2nd Ed. | £ 3.75 |
| 21599 Practical Low-Cost IC Projects 2nd Ed. | £ 3.50 |
| 21557 Practical RF Communication Data for Engineers and Technicians | £ 6.75 |
| 21651 Programming and Interfacing the 6502 | £10.50 |
| 21482 Regulated Power Supplies 2nd Ed. | £ 7.50 |
| 21419 Security Electronics 2nd Ed. | £ 4.50 |
| 21541 8080/8085 Software Design | £ 7.25 |
| 21615 8080/8085 Software Design — Book 2 | £ 7.50 |
| 21656 6502 Software Design | £ 7.50 |
| 21621 Solar Heating | £ 5.25 |
| 21587 The S-100 and Other Microbuses | £ 4.50 |
| 21628 TEA: An 8080/8085 Co-Resident Editor/Assembler | £ 6.75 |
| 21538 The 555 Timer Applications Source-Book with Experiments | £ 4.50 |
| 21633 TRS-80 Interfacing | £ 6.75 |
| 21035 TTL Cookbook | £ 7.25 |
| 21103 Troubleshooting with the Oscilloscope 3rd Ed. | £ 4.50 |
| 21313 TV Typewriter Cookbook | £ 7.50 |
| 21339 Video Security Systems | £ 5.25 |
| 21521 Video Tape Recorders | £ 7.50 |
| 21682 Z80 Microcomputer Design Projects | £ 9.75 |
| 21609 Z80 Microprocessor Programming and Interfacing — Book 1 | £ 8.25 |
| 21610 Z80 Microprocessor Programming and Interfacing — Book 2 | £ 9.75 |



• Circle No. 292

SPOT COMPUTER SYSTEMS LTD.

New St. Kelham St Industrial Est.
Doncaster Telephone 0302-25159

The SPOT for service in Yorkshire

Apple 11 Plus Systems — from £695

| Hardware | | Software | |
|----------------------|-----|------------------|-----|
| ROM + Card | 116 | All Computech | |
| Lower case adaptor | 45 | packages stocked | |
| Computech serial I/F | 80 | Database | 120 |
| Paper Tiger | 598 | Apple-Pip | 95 |
| Graphics S/W disc | 20 | Utilities pack | 20 |
| OKI Microline 80 | 499 | Applewriter | 42 |

North Star Horizon 64K with 2 DD drives 2100

| | | | |
|----------------|------|------------|-----|
| TVI912 Video | 575 | CP/M 2.2 | 95 |
| Texas TI810 RO | 1450 | CBASIC-2 | 75 |
| Qume 5/45 RO | 1950 | Wordstar | 255 |
| Qume 5/45 KRS | 2350 | Mail/Merge | 85 |

Graffcom & Graham Dorian Software stocked
BASF 5.25" Minidiscs £25 per box of 10
9 1/2" x 11" plain listing paper £16/box of 2000

The above is just a selection from our range which is on demonstration at all times.

• Circle No. 293

INTELLIGENT ARTEFACTS LTD.

SMALL COMPANY ACCOUNTS

SOFTWARE FOR NORTH STAR

- COMBINED CASH/DAY BOOK TRANSACTION FILE+ACCOUNT NAMES
- COMBINED SALES/PURCHASE LEDGER
- INTERACTIVE-TOLERANT NAME MATCHING, ERROR CHECKING, etc.
- COST AREA ANALYSIS
- AGED DEBT ANALYSIS, STATEMENTS
- AUDIT TRAIL
- AUTO BANK BALANCE
- MANAGEMENT REPORTS - PROFIT/LOSS, ASSET RATIOS, etc.
- APPROVED VAT METHOD
- FAST, FREE MAINTENANCE
- LOCKED BASIC WITH 3-LEVEL PASSWORD SYSTEM
- NO SPECIAL STATIONERY REQUIRED
- TAILORING SERVICE
- £520 + VAT
- COMPLETE SYSTEMS WITH HARDWARE from £3,300

INTELLIGENT ARTEFACTS LTD.

Cambridge Road, Orwell, Royston, Herts.
Telephone: Arrington 689

• Circle No. 294

OFFICIAL COMMODORE, ACT, AND SHARP DEALERS

Specialists in micro-computer applications

c s
ca is
cad dis
cadd ddis
caddi addis
caddiscaddis
caddi addis
cadd ddis
cad dis
ca is
c s

Caddis Computer Systems Ltd



*** LOOK LOW PRICES!! AND PROFESSIONAL SERVICE ***

| COMMODORE | RRP | CADDIS |
|---|------|--------|
| 8K PET Graphics Keyboard | 425 | 405 |
| 8K PET Business Keyboard | 450 | 425 |
| 16K PET Business Keyboard | 550 | 520 |
| 32K PET Business Keyboard | 695 | 650 |
| PRINTER 3022 | 425 | 405 |
| DISKDRIVE 2040 | 695 | 650 |
| CASSETTE DRIVE | 55 | 50 |
| COMPUTHINK | | |
| DISKDRIVE 400K old ROM | 795 | 755 |
| DISKDRIVE 400K new ROM | 895 | 850 |
| DISKDRIVE 800K new ROM | 1145 | 1070 |
| TELETYPE 43 | 900 | 825 |
| DECWRITER LA34 | 925 | 825 |
| SHARK MZ80K 34K Model (All models available) | 599 | 570 |

CADDIS INTERFACES Full range for professional and hobbyist applications e.g. IEEE488 to RS232C; PARALLEL I/O; Analogue I/O etc.

SOFTWARE Full range of Business and Education Software by ACT, COMMODORE, H.B., PETSOFTE etc.

DESIGN Our team of professional engineers will design interfaces, software packages, or systems to your requirements. LEASING facilities available to suitable clients.

DELIVERY arranged by REDSTAR or SECURICOR.

ALL EQUIPMENT CAN BE SUPPLIED MAIL ORDER (Cash with Order Please).

The above is only a selection of the equipment we can supply. Please ring for further details.

72-74, TRINITY LANE, HINCKLEY, LEICS.
TEL. HINCKLEY (0455) 613544

ALL PRICES EXCLUDE VAT & CARRIAGE

• Circle No. 295

DIRTY MAINS! CORRUPT DATA?

Is your computer suffering from the effects of unstable mains or from high voltage transients and momentary supply breaks, which you probably do not even notice otherwise?

Have you counted the cost of the loss of a day's data input or, worse still, the corruption of a whole programme?

If not, when you do you may get an unpleasant surprise — particularly if you then compare it with the low cost of a Galatrek Constant Voltage Transformer.



For a cost ranging from only £75 (ex workd) + VAT you can get:—

- * STABILISATION OF $\pm 1\%$
- * TRANSIENT ATTENUATION
- * MOMENTARY POWER BACK-UP
- * RAPID RESPONSE
- * OUTPUT TOTALLY ISOLATED
- * PROTECTION FOR STABILISER AND EQUIPMENT UNDER OVERLOAD AND SHORT-CIRCUIT CONDITIONS

Standard range covers ratings from 250VA to 5kVA. Higher ratings to order.

Model AK250 at £75 ex works + VAT, one of a range of 90 models covering most voltages.

Galatrek VOLSTAB Constant Voltage Transformers are based on a Galatrek innovation on the well established ferro-resonant saturable reactor technique. They offer high performance with minimal size and weight at a highly competitive price.

They contain no moving parts and are very reliable in service. They will provide close regulation within the limits specified. So consider carefully the Six Star Features listed above. And consider carefully the cost of system 'hiccups' resulting from mains supply irregularities.

Then complete the coupon below to secure your copy of our new 12 page catalogue listing our whole range of stabilisers and cutouts. Or ring Ron Koffler on 0492 640311.



Scotland Street, Llanrwst,
Gwynedd LL26 0AL. North Wales, Britain.
Telephone: Llanrwst (0492) 640311
Telex: 617114 Answer back—GALAHU
Telegraphic Address GALAWATT.

U.K. Marketing Agent:
Danesbury Marketing Ltd.,
Tavistock House,
Bedford MK40 2QD
Tel: 0234 213571 Telex: 825633 OTSS-B

CUTOUT NOW AND POST TODAY

ON FREEPOST LL99 No stamp necessary

Mark first class

- PLEASE recommend a stabiliser for the following:

.....
.....

- PLEASE send me your new 12 page catalogue

Name

Sent By

Tel No

Tick if trade Tick if OEM

Address

.....

PC10

MICRO BUSINESS CENTRE

YOUR WEST MIDLAND APPLE II : ITT 2020 DEALERS SPECIALISTS IN QUALITY BUSINESS SOFTWARE

| | | | |
|---|-----------|-----------------|------|
| Integrated Stock/Invoice/ Sales/Purchase | £1000 | Apple II 16K | £695 |
| Payroll | £295 | ITT 2020 16K | £750 |
| Sales Ledger | £295 | 16K Upgrades | £79 |
| Purchase Ledger | £295 | Disk Drive | £299 |
| Nominal Ledger | £295 | With Contr. | £349 |
| Stock Control | £100 | <i>Printers</i> | |
| Incomplete Records | £450 | OKI Microline | £495 |
| Visicalc | £95 | Centronics 799 | £825 |
| Word Processing | from £150 | Paper Tiger | £585 |
| The Cashier — | | Anadex DP 8000 | £675 |
| Complete Package | £195 | TCM200 | £395 |
| For Sole Trader | | | |
| Financial Planning | £295 | | |

* special 04 GAMES DISK inc. SPACE INVADERS £10

ALL PRICES EX. VAT UNLESS STATED
SEND REMITTANCE WITH ORDER

CASTLEBRIDGE HOUSE
LICHFIELD ROAD, WEDNESFIELD
WOLVERHAMPTON. TEL: (0902) 732687

DEMONSTRATIONS FREELY GIVEN BY APPOINTMENT
BARCLAYCARD: ACCESS: TERMS ARRANGED

• Circle No. 297

BEAVER
SYSTEMS



Norlett House
Dormer Road
Thame
Oxon OX9 3UC
Telephone Thame
(084421) 5020 (24 hr)

YOUR COMPLETE OHIO SCIENTIFIC SERVICE

HERE ARE FIVE VERY GOOD REASONS FOR CALLING US —

- 1. O.S.I. SYSTEMS**
— including the popular SUPERBOARD II and CHALLENGER 4P as either cassette or disc based systems.
- 2. O.S.I. SOFTWARE**
— cassette and disk based software covering a broad spectrum of uses. Some of the cassette based software can also be run on the U.K.101.
- 3. BEAVER SOFTWARE**
— Business, educational and entertainment software — professional programs with full listings and documentation. Also available for other systems — especially the U.K.101.
- 4. BEAVER PROGRAMMING AIDS**
— including Video Workpads, BASIC workpads, Machine Code Workpads, Cassette Index cards and labels and Blank Cassettes, all available for OSI, U.K.101, and TRS-80.
- 5. BEAVER EXPANSION**
— Economy memory expansion using motherboard and slot-in 8K RAM boards, 8K EPROM boards, floppy control board & shortly, PROM Programmer board. Buy as much as you need when you need it.



CALL OR WRITE... NOW!



• Circle No. 298

FOR USE WITH PRINTERS WITH THE TRS-80 AND VIDEO GENIE

WORD PROCESSOR

The Kansas Word Processor is very extensive indeed, with 17 main commands: Add, Blank, Compile, Delete, Edit, Exit, Format, Help, Insert, Justify, Kill, Load, Move, Print, Replace, Save, Video.

It has numerous sub-commands controlling the cursor and justifying in the Add command.

The Edit command is very extensive, allowing infinite control as well as hack and insert.

The Format mode has its own commands allowing specification of lines, spaces, numbers, headings, caps and lower case, etc.

It is a very powerful Word Processor indeed, yet is offered at an extremely competitive price.

PRINTER CONTROL £18.50

This program allows software control of the output to the printer.

It includes control of the characters per line, margin spaces, line length, normal page length, maximum page length, text length, line feed, double spacing and tear line.

An essential utility for anyone with a printer.

LPRINT £11.25

This program changes all the Basic PRINT statements to LPRINT, by a single command.

It also changes them back from LPRINT to PRINT, again by a single command. £6.25

SCREEN PRINT

This useful utility allows the entire contents of the screen to be outputted, exactly as seen, to the printer, by a simple command.

TYPEWRITER

When normally outputting to a printer, shift produces lower case whilst the normal keys produce caps. This infuriating thing can be overcome by this program which outputs caps when the shift key is held down and lower case in the normal position — like a typewriter. £6.25

REPEAT

Turn your keyboard into a modern electric typewriter with this utility which allows any key to repeat simply by holding it down, yet works normally otherwise. £6.25

DE-SLASH

There is nothing worse than seeing all those 'crossed' noughts on the printer's output. This program takes them out, allowing normal noughts to be printed. £6.25

REMEMBER — WE OPERATE A FIRST CLASS RETURN POST SERVICE.

Programs are cassette based and recorded at different levels to suit all cassette systems.



Kansas

Unit 3, Sutton Springs Wood, Chesterfield — 0246 850357

• Circle No. 299



PET 2001

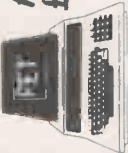

from £495

commodore authorised dealers

TRS 80



from £365

From Radio Shack Corp.

APPLE II

from £695



authorised dealers

SORCEROR

from £730



authorised dealers

ADVANCED SYSTEMS



MICROCOMPUTERS ETC

For Hardware, Software, Peripherals, Consultancy and Competitive Prices.

Registered business name



DISKS

- PET 3040 (dual drive) 343K User storage * £695.00
- Computhink (dual drive) 400K £895.00
- Computhink (dual drive) 800K storage £1145.00
- Microdisk drive £398.00
- Microdisk drive £298.00
- Percom FD0200 drive 110v £288.00
- Macropolis Dual Drive (FSK storage) £995.00
- Corvus Hard Disk (11mb) £3500.00
- APPLE Disk - 118K storage 1st drive £348.00
- APPLE Disk - 118K storage 2nd drive £299.00
- Corvus Hard Disk (11mb) £3500.00
- SORCEROR £485.00
- Study Dual Disk (8k storage) £1195.00
- Corvus Hard Disk (11mb) £3500.00

PRINTERS

- PET 3022 80 col with PET graphics £425.00
- TRIS80 £345.00
- TRS 80 Screen Printer (11mb) £1110.00
- New Radio Shack Micro Printer £245.00
- Teletype 43 KSR Serial (pin or punch) £325.00
- Read 132 col £1245.00
- P.A. printers for microcomputers - high speed (up to 280 cps, upper/lower case) P.O.A.
- OKI - parallel serial (pin or punch) £499.00
- Read 40, 80, 132 cols (selectable) £1825.00
- DOLPHIN B260P tractor printer (125 cps bi-directional, 40, 80 columns - optional 132, w/ case & graphics. Available with Centronics Micro Printer £250.00)
- 80 cols (selectable) £395.00
- Health WH 14 serial (80, 96, 132 cols selectable) £1275.00
- P.O.A.
- DUME daisy wheel printers £266.00
- TCX1000 Microdot Serial Printer (40 col) £266.00
- SILENT PRINTER for APPLE... allows printing of high res. graphics. £349

SOFTWARE

- PET/STOFF - authorised dealers - over 160 programmes on cassette and disk. Send for catalogue
- STAGE ONE COMPUTERS SW dealers - PET/AD, Stock Control, etc. Send for list.
- 74 Common BASIC Programs on one tape £15.00
- PET/ACT Business Software - Sales and Purchase Ledger, Invoicing, etc. P.O.A.
- CBM 118BASED BUSINESS SOFTWARE £150.00
- COMSTOCK - STOCK CONTROL - gives complete stock report £150.00
- COMBIS - BUSINESS INFORMATION SYSTEM - Storage & Retrieval of all types of company records £150.00
- COM ACCOUNTS - Full Financial Business Accounting System (incl. Purpose, Journal, Ledger, or monthly paid employees) £650.00
- COMPLANNER - Personal information tool for the busy executive £150.00
- COMPLANNER - Personal information tool for the busy executive £50.00
- IW are authorised CBM Business Software Dealers) Send for List.
- GO 1101 - Assembler Development System £50.00
- GO 010 - Lisp Interpretive Language (Artificial Intelligence) £78.00
- CAR INSURANCE QUOTATIONS (TVJ S/W) - personalised car insurance quotation £25.00
- MORTGAGE QUOTATIONS - suitable for agents/mortgage brokers (TVJ S/W) £25.00
- TRIS III SUITE - computerised accounting for TRS 80 (TVJ SOFTWARE) £75.00
- STOCK CONTROL - complete inventory control - recorder level - P/O's etc £98.00
- CBASIC £79.00
- FORTAN includes compiler, relocatable assembler (text editor and linking loader) £98.00
- PASCAL - temporary's programming language today £195.00
- ELECTRIC PENICIL - powerful word processor allows full cursor movement, justification on cassette £45.00
- ELECTRIC PENCIL as above - disk version £95.00
- LOWER CASE MOD KIT ONLY/FITTED for Electric Pencil £8 00/£28.00
- DATA MANAGEMENT/REPORT GENERATOR - easily formats disk files, allows entry, edit, delete and list on records and retrieves data for display or break routine £150.00
- RSM-2D DISK MONITOR - powerful system manipulates disk data, has 2.80 £26.00
- ST800 communications software £26.00
- NEWDOCS - TRSDOS with corrections and enhancements £25.00
- NEWDOCS - as above but with further facilities. DOS commands from BASIC level via Superzap, Disassemble, load and save faster, list variables £49.00
- LIBRARY 100 - an assortment of 100 programs £39.00
- SARGON CHESS - 16K Level II - the 1975 Champ Version! £14.00
- APPLE Macintosh 2.0 Chess Disk £15.00
- U-DRAW II - High Resolution graphics editor. Create a figure then rotate, expand, contract etc and store on disk £27.00
- USP - programming language suitable for research in artificial intelligence £22.00
- 3-MILE ISLAND - Complex disk based game simulating nuclear reactor £27.50
- VISUAL C - Instant Visual Calculator - provides a powerful planning and forecasting £95.00
- APPLE WORD PROCESSOR - Complete text editing, storage and retrieval of text (disk based) £42.00
- LITTLE GENIUS - Comprehensive disk based Apple Soft Tutorial £36.00
- ACT Appleware and MUSE authorised software dealers - Many programs on cassette and disk. Send for list.
- SORCEROR many programs available - send for list. £120
- Word Processor Rompac Development Pac £70.00

SOFTWARE

- * 5% DISCOUNT ALLOWED FOR EDUCATIONAL ESTABLISHMENTS

SOFTWARE

- PROFORMABLE CALCULATORS, TEXAS INSTRUMENTS Business Programmable Calculators - complete range. Send for list + £580.00
- IF YOU DON'T SEE IT - ASK IF WE HAVE IT

SOFTWARE

- PROFORMABLE CALCULATORS, TEXAS INSTRUMENTS Business Programmable Calculators - complete range. Send for list + £580.00
- IF YOU DON'T SEE IT - ASK IF WE HAVE IT

SOFTWARE

- PROFORMABLE CALCULATORS, TEXAS INSTRUMENTS Business Programmable Calculators - complete range. Send for list + £580.00
- IF YOU DON'T SEE IT - ASK IF WE HAVE IT

SOFTWARE

- PROFORMABLE CALCULATORS, TEXAS INSTRUMENTS Business Programmable Calculators - complete range. Send for list + £580.00
- IF YOU DON'T SEE IT - ASK IF WE HAVE IT

SOFTWARE

- PROFORMABLE CALCULATORS, TEXAS INSTRUMENTS Business Programmable Calculators - complete range. Send for list + £580.00
- IF YOU DON'T SEE IT - ASK IF WE HAVE IT

SOFTWARE

- PROFORMABLE CALCULATORS, TEXAS INSTRUMENTS Business Programmable Calculators - complete range. Send for list + £580.00
- IF YOU DON'T SEE IT - ASK IF WE HAVE IT

SOFTWARE

- PROFORMABLE CALCULATORS, TEXAS INSTRUMENTS Business Programmable Calculators - complete range. Send for list + £580.00
- IF YOU DON'T SEE IT - ASK IF WE HAVE IT

SOFTWARE

- PROFORMABLE CALCULATORS, TEXAS INSTRUMENTS Business Programmable Calculators - complete range. Send for list + £580.00
- IF YOU DON'T SEE IT - ASK IF WE HAVE IT

TVJ
Member of the TV Johnson Group of Companies

Orford 148 Cowley Road, Orford
Oxford OX4 1JJ
☎ (0865) 721461

Bristol 48 Gloucester Road, Bristol
BS7 8BH
☎ (0272) 422061

London 148 Cowley Road, Orford, Suffolk
☎ (0276) 20446

Hours of business
Mon-Fri 9.30 - 5.30
Sat 9.00 - 12.30

+ Anseback eyes and w/ends
Tel: 858893

D: P.V. King, MBE
S: J. Johnson, A.B.A., A.C.M.B., F.R.C.S., M.B.M.
P.O. BOX 121, BRICKLAYS
15, JOHNSON, A.B.A., A.C.M.B., F.R.C.S., M.B.M.
(all prices correct at time of compilation)

MONITORS B&W — GREEN — COLOUR

| | |
|----------------------------|------|
| 9" GREEN (IDEAL APPLE/ITT) | £155 |
| 9" B&W | £136 |
| 12" B&W | £175 |
| 14" B&W | £189 |
| 17" B&W | £225 |

TOP QUALITY, HIGH RESOLUTION MONITORS GUARANTEED 12 MONTHS. CARRIAGE/V.A.T. EXTRA. FULL RANGE OF B&W AND COLOUR RECEIVER MONITORS AVAILABLE, P.O.A.

DEALER ENQUIRIES WELCOME

HAMM & GIBSON
MONITOR & VIDEO SPECIALISTS
43 MALDEN WAY, NEW MALDEN
SURREY KT3 6EA
01-942 9635

• Circle No. 301

SUPERBOARD 2 OHIO SCIENTIFIC

The ideal impact matrix printer for Superboard, UK101, Pet, Apple, TRS80, MZ-80k, 60 lines/minute, 72, 80, 96, 120 and 132 chr/line. Tractor and friction feed. Graphics and user definable chr sets. RS232, 20ma, IEEE488 and centronics I/O. SPECIAL OFFER: — Supplied with free word processor program and interface components £399 + 15% VAT.

SUPER PRINT 800MST

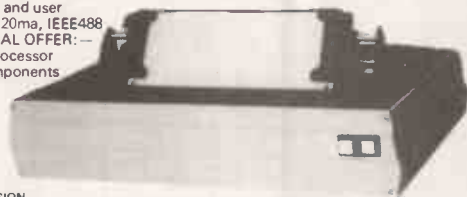

50ZH BLACK AND WHITE VERSION
£159.95 + 15% VAT POST FREE.

50HZ COLOUR VERSION £206 + 15% VAT.

THIS UNIQUE SPECIAL OFFER.

If bought with superboard or colourboard these items are at the reduced prices shown first. Also sold separately at the bracketed prices. Add 15% vat. Modulator and power supply kit £7.95 (£11). 4K extra ram £20 (£24). Display expansion kit approx 30 lines x 54 characters £15 (£20). Case £23 (£26). Colour conversion board fully assembled £45 (£45). Cassette recorder £13 (£15). Extended monitor £20 (£20). Assembler/Editor £25 (£25). 610 Expansion Board £160 (£160).

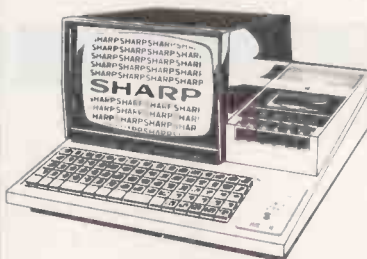

SHARP MZ-80K

The brilliant new Japanese computer 20K ram expandable to 48K. Built in VDU screen, music function and cassette. Displays 40 characters x 25 lines and 80 x 50 on graphics. £465 + 15% VAT.

SWANLEY ELECTRONICS

Dept. PC, 32 Goldsel Rd., Swanley, Kent BR8 8EZ.
Mail order only. Please add 35p postage. Prices include VAT unless stated.
Lists 27p post free. Overseas customers deduct 13%. Official credit orders welcome.

• Circle No. 302

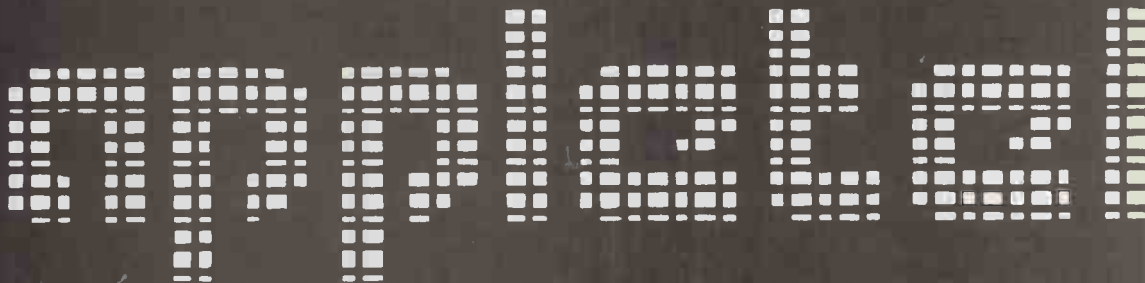

The Prestel connection for the Apple II



— access Prestel

— store and process information pages

— create your own pages

For the Prestel user and
Information Provider

£595 + VAT

Also Apple software from Owl Computers:

LISP language £58 + VAT

Microayd assembler £50 + VAT



Owl Computers

18 Hadham Road,
Bishop's Stortford, Herts. CM23 2QR
Telephone: (0279) 52682

• Circle No. 303

SIRTON COMPUTERS



76 Godstone Road, Kenley (Nr Croydon) Surrey CR2 5AA
Tel: 01-668 0761/2

MIDAS S.100 SYSTEMS

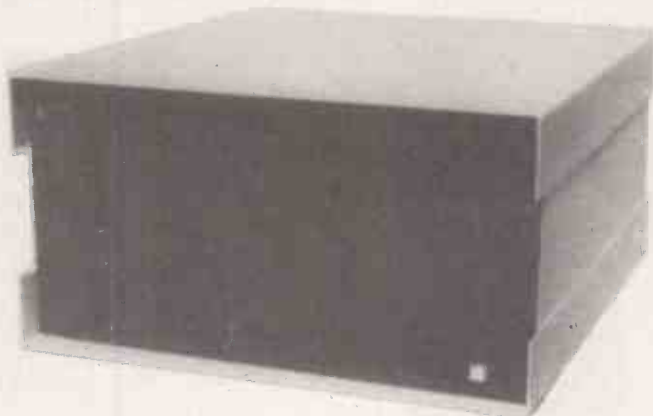

MIDAS 1: From £750
MIDAS 2: From £1580
MIDAS 3: From £2150
MIDAS 4: From £5900
ITHACA-DPS 1: From £1075

- Our versatile Z80 Microcomputers are available as standard units or custom configured to your exact specification from a comprehensive range of stocked S100 boards.
- Disc storage capacity of the MIDAS 3 can be 2M Bytes, expandable to over 20M Bytes with a Winchester Hard Disc Unit in our MIDAS 4 range.
- MIDAS runs CP/M and MP/M is also available. Other Software includes M-BASIC, C-BASIC, FORTRAN, COBOL, CIS-COBOL, PASCAL and Word Processing.
- **A MIDAS 3, with 64K RAM and 2M Bytes storage on two 8" drives with two Serial I/O Ports and CP/M 2 only £2600.**
- Printers, VDUs and other peripherals stocked to give complete package systems at keen prices.
- Business Packages include Accounts, Stock Control, Purchase Ledger etc etc.
- OEM and Dealer enquiries welcome.

Boards stocked from Ithaca, Godbout, SSM, S D Systems, Vector, Micromation, Mullen, Mountain Hardware, Hi-Tech, Video Vector, Pickles & Trout, Central Data, Cromemco, Thinker Toys — Send for full Price List (many available in kit form).

| | | | |
|-------------------------|-----------|----------------------------------|-----------|
| Processor | | | |
| Z80 Starter Kit | £188 | RAM | |
| SBC100 | £208 | Dynamic RAM 16K-64K | from £205 |
| SBC200 | £237 | Static RAM 8K-64K | from £95 |
| Z80 CPU 4 MHz | from £130 | Memory Manager | £52 |
| | | I/O | |
| EPROM | | 2S/4P prov 4K RAM/4K ROM | £169 |
| 2708 EPROM (16K) | £60 | 2S/2P or 2S/4P or 3P/1S or 4S/2P | from £135 |
| 2708/2716 Programmer | from £134 | Analogue 8 or 12 bit | from £287 |
| | | Optically isolated I/O | £114 |
| Video | | IEEE 488 Interface | £350 |
| 16 lines, 32/64 ch | from £104 | Miscellaneous | |
| 24 lines, 84 ch | from £265 | Real Time Clock | £180 |
| | | High Dens Graph/8K RAM | £333 |
| Disc Controllers | | Hi-Tech Colour | £295 |
| Versafloppy S/D | £198 | Motherboards — various from | £34 |
| Doubler D/D | £280 | Extender Board/logic probe | £39 |
| | | Maths Board AMD 9511 | £330 |

Software
 CP/M 1 & 2, MP/M, PL/1, C-BASIC 2, M-BASIC V5, XYBASIC, FORTRAN 80, COBOL 80, CIS-COBOL, PASCAL/Z, PASCAL (UCSD), PASCAL M/T, Forth, MAC, ZSID, Disassembler, Wordstar, Datastar, Magic Wand, Wordmaster, Supersort etc etc.

WRITE OR PHONE FOR CATALOGUE
SIRTON COMPUTERS WAS FORMERLY SIRTON PRODUCTS

•Circle No. 304

MICRO-FACILITIES

127 HIGH STREET
HAMPTON HILL
MIDDLESEX

01-979 4546
01-941 1197

MIDDLESEX & S.W.LONDON

Approved Business Dealers for:

Commodore Computers & Business Packages
Apple II
North Star Horizon
IMS 5000/8000 Series

As fully authorised Dealers for the above equipment, and as experienced data processing professionals, we are the best people to help you.

Our complete package offers you:

Free initial discussion & advice
Systems Design & Programming
Software Packages
Supply & Installation of equipment
Leasing & Financing terms
Full Maintenance Contracts
Genuine After Sales Service

Contact us to discuss your problems and requirements, we offer you a lot more, but only charge the same. Our ability will give you peace of mind and confidence that the job will be done properly.

•Circle No. 305

PET SLAVE!!

Qwerty Computer Services now offer a Remote Station which plugs into your PET. It is now possible to utilise your PET (from a distant point) to input/output/load/save/develop/run programs. Price **£325.00**

High Resolution analogue to digital converter. Resolution typ. 0.05% (equivalent to 12 bit), Accuracy typ. 0.05% (5v supply). Price **£50.00**.

Also available:

Soundbox **£20**, TV/Video Interface **£42**, Light Pen **£25**, Userport Interface **£35**, Repeat Key **£17.50**, Crash Restorer **£14.50**,
Keyboards: **£68** uncased, **£85** cased,
Programs **£1.25** each. C12 cassettes **£4.00** for 10. Disks **£25** for 10.

TRS interfaces also available

Trade/export enquiries invited. Prices exclude VAT. Please add 15% to payment.

Qwerty Computer Services,
20 Worcester Road,
Newton Hall,
Durham.
Tel. (0385) 67045

• Circle No. 306

Trident



£670.00

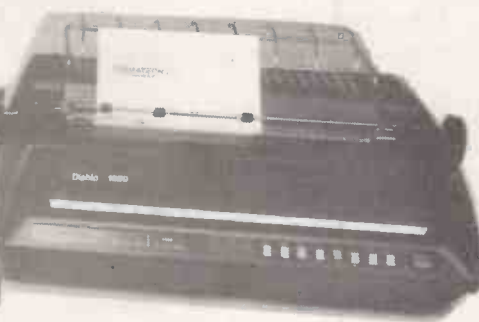

£2150.00

£2650.00

Configuration shown is for word processing including WORDSTAR £5450

- ★ Full Business Systems available
- ★ 64K 4MUZ Memory
- ★ Rack Mounting available
- ★ Interface to most VDUS and printers
- ★ Wide range of high level Languages available
- ★ Fastest CPM Machine
- ★ 6 slot S100 mother board
- ★ 2 or 4MBYTE Disc Storage

SIGMATECH LTD.
ELECTRONICS

For further information:- Tel: (0734) 587000
22, Portman Road, Battle Farm Estate, Reading, Berks.

•Circle No. 307

**THE LEADING EXHIBITION OF
COMPUTERS, PERIPHERALS
AND SYSTEMS**

COMPEX '80

will be in the Grand Hall
OLYMPIA, LONDON
November 4, 5 & 6, 1980

**CAN YOU AFFORD
TO MISS
BRITAIN'S BIGGEST
COMPUTER
EXHIBITION?**

**TRADE ONLY – NO SCHOOL PARTIES – NO ADMITTANCE UNDER 16
ENTRANCE £2**

Sponsored by "Computer Weekly," "Data Processing," "Practical Computing" and
"Systems International" and with the support of "Electronics Weekly" –
all members of IPC Business Press, the worlds largest publisher of specialist and
business journals.



Westrex Company Limited
are pleased to announce
their re-location to a
new factory at
**Bilton Fairway Estate
Long Drive Greenford
Middlesex**
from September 1, 1980

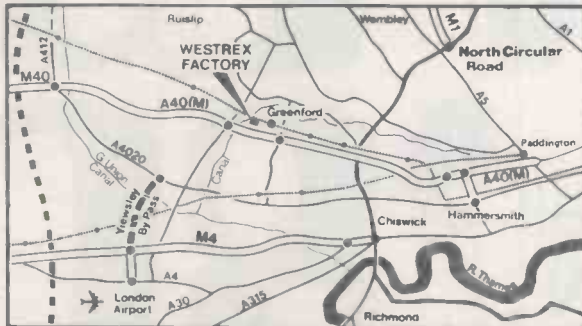

Tel: 01 578 0950 & 578 0957/8/9

• Circle No. 308

MICRO SPEECH 2 DOES YOUR COMPUTER SPEAK TO YOU?

MICROSPEECH 2 is a stand alone speech synthesizing unit. It converts phonetic code or any ASCII text into a speech output. MICROSPEECH 2 may be interfaced to any computer system because all the computation necessary to synthesize speech is performed by its own dedicated microprocessor. Up to one thousand phonetic characters, representing about one minute of speech, may be assembled in the units internal buffer before it is commanded to speak.

FEATURES

- Runs from phonetic code, giving unlimited vocabulary and simple operating software.
- Optional English to phonetics translator allows operation directly from ordinary text.
- Uses standard RS232C/V24 interface.
- Totally self contained with internal loudspeaker and power supply.
- No need to worry about complex interfacing or support software.



PRICE

Phonetic model £875.00 +

VAT

Phonetic model plus Eng-

lish to phonetics translator

..... £950.00 + VAT

Available from:

COSTRONICS ELECTRONICS 13 Field Heath Avenue,

Hillingdon, Middlesex Uxbridge (89) 38791

TIM ORR DESIGN CONSULTANT

55 Drive Mansions, Fulham Rd, London SW6

(01) 7312077

• Circle No. 309

INTEGRATED SMALL BUSINESS SOFTWARE ISBS

**GRAFFCOM
SYSTEMS GROUP**

ISBS MODULES

● **PAYROLL** Standard PAYE/HMI Taxes routines, 250 employees, weekly or monthly, cash, cheque or bank giro, cumulative YTD figures, employee lists, payroll logs, pay slips and giro slips.

● **COMPANY SALES** Complete sales accounting, invoice control & analysis, sales ledger, aged debtors reports, statements, VAT control, variable accounting periods, credit control and customer maintenance.

● **COMPANY PURCHASES** Complete purchase accounting, invoice control analysis, purchase ledger, aged creditors reports, payment advices, Vat control, variable accounting periods.

● **STOCK CONTROL** Maintains stock records, monitors stock levels for optimisation. Stock descriptions, codes, unit prices, selling prices quantity on hand/min/on order/re-order/allocated/unsatisfied, analysis reports, price lists, parts explosion.

● **ORDER ENTRY & INVOICING** Invoices for services and consumable items, part orders or part quantities, sales analysis reports showing movements and trends over user defined periods.

● **GENERAL ACCOUNTING** Nominal ledger, trial balance, profit & loss, balance sheet, user defined cost coding system and accounting periods.

● **NAME & ADDRESS** Complete control of names & addresses, user defined coding system, report generator produces selective reports, prints anything from mailing labels to directories.

Designed for most of the popular 8080/Z80 Microcomputer disk systems running under CP/M*. Requires 48K memory, dual floppy disks (or large fixed disk system), VDU and 132 col printer.
GRAFFCOM SYSTEMS LTD, 52 SHAFESBURY AVENUE, LONDON W1. 01-734 8862.

*CP/M is a trademark of Digital Research.

• Circle No. 310

LEARNING TO BE PATIENT ISN'T PART OF THE SYLLABUS.

Compared with other educational computers, our Tandberg EC10 is mastermind.

It's the one that can handle up to 7 V.D.U.'s.

So if you include the master keyboard, the 'mind' of our computer can teach up to 8 pupils at a time. Individually.

That way your pupils learn extended basic computer language quicker.

And patience becomes something they learn about elsewhere.

The Tandberg EC10 is masterful in other ways too.

That's because it's the brainchild of a company that specialises in educational computers.

So its not a sawn-off version of somebody else's small business system, dependent on slow cassettes for program storage.

This means it runs as quietly as a well-ordered class; is as physically neat as a school-boy on his first day; and no education committee's going to query it's running costs.

The capability of the EC10 extends to commercial Basic and Cobol languages, printer

interface and V24 interface for other mainframe computers.

Moreover it can be programmed to handle educational administration.

By now we hope you're impatient for further information.

So send off the coupon and we promise we won't keep you waiting either.

To: Tandberg Ltd., 81 Kirkstall Road, Leeds LS3 1HR
"PLEASE DESPATCH EXPANDED DATA"

ENTER
Name _____

PC7

Address _____

Postcode _____

SELECT

School

College

Local Authority

TANDBERG
Education Division



•Circle No. 311

An APL Microcomputer really makes most sense of all !

apl interpreter £345



APL SUPERBRAIN £1995

... or you can invest in our own *MAPLE* system, with the option of upgrading to a Z-8000 when the software becomes available.

A.P. Ltd. are *the* microcomputer APL specialists. If you are going into this languages, you can be sure of getting just as much support as you need to help you on your way.

APL is in no way an Academic's language: its merit lies in the speed that software can be developed — a factor of 6 over standard languages is not overstating the case! So often we get enquiries from firms who have purchased a microcomputer, and belatedly discovered APL. They ask: "Can we run APL on our ...?" Be wise, whether you use Basic, Fortran, Pascal, make sure you have genuine APL capability whether you intend to use it or not.

New! APL in Practice by Rose and Schick
Order now, price £13.60
For non-APLers — the latest publication from A P Ltd.
APL — An Appreciation price £3.50

At no extra cost you can now purchase an APL Superbrain and have the option of using this most magnificent of all computer languages. All of the standard languages are available too, of course, so you have absolutely nothing to lose ...

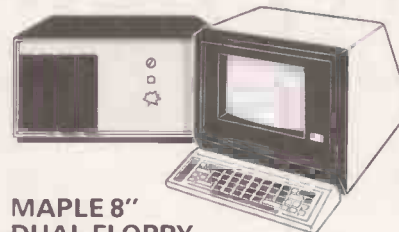

**MAPLE 8''
DUAL FLOPPY
SYSTEM £3200**

**Alan
Pearman
Limited** Tel: (0244) 46024
or write
A P Ltd
Freeport
Chester CH3 5YZ

IF YOU LIVE IN SCOTLAND, you may contact our Scottish representative
CALEDONIA BUSINESS SYSTEMS, Glasgow (041) 956 6121

APPLE AND CHIPS!
We now supply APPLE II with CP/M and
APL capability

• Circle No. 312

aculab

floppy tape,

The tape that behaves like a disc,
For TRS-80 LEVEL II.

Connects directly to TRS-80 Level 2 Keyboard. Operating and file handling software in ROM. 8 commands add 12 powerful functions to Level 2 BASIC. No buttons, switches or volume controls. Full control of all functions from Keyboard or program. Daisy chain multiple drives. Certified digital tape in endless loop cartridges. Reads and writes in FM format at 9000 Baud. Soft sectored with parity and checksum error detection for highly reliable operation—just like discs. Maintains directory with up to 32 files on each tape, tapes may be write-protected. Supports Basic and machine-language program files, memory image and random access data files. 12 character filespecs —: "FILENAME/EXT:d" (d is drive no. 0-7). Automatic keyboard debounce. Full manual with programming examples and useful file-handling routines.

COMMANDS (usually followed with a filespec and possible parameter list).

@SAVE, @LOAD, @RUN —for BASIC programs, machine language programs and memory image files. @GET, @PUT —moves a 256-byte record between a random access file and BASIC's data buffer. @KILL —removes a file from the directory and releases tape sectors for immediate re-use. @LIST —displays file directory along with sector allocation and free sectors. @NEW —formats tape and creates a blank directory.

Master drive with PSU, Manual and a selection of tapes

£167-00 +£2-00 pp+vat.

Slave drives with PSU £122-00 +£2-00 pp+vat.

(Export orders pp charged at cost)



introductory
offer

For further
information,
Telephone
0525 371393

aculab Ltd.
24 Heath Road,
Leighton Buzzard,
Beds. LU7 8AB

• Circle No. 313

put the pieces together!

MICROPROCESSOR INTERFACING TECHNIQUES

THIRD EDITION

RODNEY ZAKS
AUSTIN LESEA



Microprocessor interfacing is no longer an art. It is a set of techniques, and in some cases, just a set of components. This book introduces basic interfacing concepts, and then presents in detail implementation techniques for both hardware and software. It covers the essential peripherals, from keyboard to floppy disk, as well as standard buses (S100 to IEEE 488) and introduces basic troubleshooting techniques. Ref. C207, 450pp., Third, (expanded) edition. £9.95

Sole U.K. distributor:—
COMPUTER BOOK SHOP
If your local store is out of stock, send
£9.95 to the Computer Book Shop,
Temple House, 43/48 New Street,
Birmingham B2 4LH.

•Circle No. 314

Tycho

Tycho Business Systems Ltd

TAILORED BUSINESS SYSTEMS to suit your business and pocket

BY combining the talents of programmers and accountants, TYCHO offers CP/M compatible business systems designed and written in Britain, adaptable to your requirements and complying with V.A.T. and P.A.Y.E./N.I. requirements.

OUR commercial suites include programs for
Invoicing/Inventory/Sales Ledger/Cash
Received
Purchases/Expenses/Creditors Ledger/Cash
Paid

Payroll/P.60s./P.35 General Ledger

ALL of these are available individually or as integrated systems.

SPECIALIST systems available include
Incomplete records and Accounts production
Asset registers and Summaries
Membership and Mailing Programs
'Magic Wand' The word processor that
calculates

TYCHO can supply everything for the small business
Hardware Programs Knowledge Support

For further details contact **Bob Sarah F.B.C.S.**
**Beechwood, Riseley, Reading RG7 1YA (073
583) 337 London Office: 1-9 Hills Place W.1.
01-734 4711**

•Circle No. 315

Conquer the Computer

Learn to really understand
the Computer. How it
works and operates.
Its 'language'.

How to program it and
make full use of its capabilities.



- No previous knowledge necessary.
- Special educational Mini-Computer supplied ready for use.
- Complete home study library.
- Self-test program exercises.
- Complete programming instructions using computer.
- Services of skilled tutor available.

Please send details without obligation to:—

Name

Address

BLOCK CAPS PLEASE

BRITISH NATIONAL RADIO & ELECTRONICS SCHOOL
4 Cleveland Road, St. Helier, Jersey, Channel Islands. PC9

•Circle No. 316

Chaljo Computers

Limited

COST-EFFECTIVE BUSINESS SYSTEMS

APPLICATIONS

Production Control Stock Control

Sales Ledger Purchases Ledger

Nominal Ledger Payroll

Word Processing

FEATURES

- *Proven software.
- *Applications may be free standing or totally integrated.
- *Flexibility in configuration.
- *The system will work on floppy disks and hard disks.
- *Additional VDU's and printers require no reprogramming.
- *Fast delivery of total system.

For your FREE SURVEY contact:

Mike Lynn

**55-57 Station Road, Edgware,
Middlesex HA8 7LJ.
Telephone: 01-346 8938**

•Circle No. 317

Write better programs for your pet using **THE PET SUBROUTINE LIBRARY**



An anthology of PET subroutines including:

Data input, special input routines to ensure correct data input — Reducing input errors by use of check digits — Date input verification and storage, avoid errors in date input — Screen formatting output — High density plotting, graphs, barplots and general purpose machine code point plotting routines — General purpose screen handler, a subroutine to perform all data input and output on the screen — Array sorts: bubblesorts, Sheilmetzner, and replacesort — Sorting and merging large disk files — Fast machine code sort package, including a binary search, data input and output to an array and machine code sort (100 element array in a couple of seconds) — Sorting with linked lists, stores data both in sorted and logical order — Sorted output on the printer, ideal for producing indexes — Sequential access disk files — Machine code sequential disk access, some ideas and tips on fast disk access — Random access disk files, an introduction with subroutines to write a random access file, either by record number or by key index — Disk utilities, display block map of disk or print contents of a disk sector — Menus for selecting options and linking programs together — Plus miscellaneous utility programs including repeat key, trace and screen printer.

Price £10.00 all inclusive

3040 format disk with all the subroutines from "LIBRARY OF PET SUBROUTINES"
Price £10.00 inclusive

THE PET REVEALED

Best selling reference book for the PET. Price £10.00

Cheques payable to Computabits Ltd

COMPUTABITS LTD,
P.O. BOX 13, YEOVIL, SOMERSET. Tel Yeovil 26522



•Circle No. 318

New and exciting Applesoft programs

NEW! the correspondent

By Roger Wagner

THE CORRESPONDENT is sure to be one of the most versatile programs in your library! It can be used as:

A Text Processor: Upper/lower case, 1-80 cols. (4-way scrolling). Text move/copy/insert/delete, tabbing, justify text, auto-centering and more!

A Database (with or without printer!) Extremely fast find routine and easy editing make it a natural for free-form data files. Create and fill out forms, access phone lists or index your magazines.

A Programming Utility: (printer or not). Examine, edit, transfer random or sequential text files. Create versatile exec. files. Even put bi-directional scrolling in your own programs!

Apple disk £29.95 + VAT

Roger's Easel

by R. Wagner

At last a program which allows you to draw colour pictures in lo-res graphics, and then permanently link them to your own Integer or Applesoft programs. Linked pictures can be displayed on either text/graphics page. (Integer basic).

Apple disk £14.95 + VAT

Apple-Doc

By Roger Wagner

An Aid to the Development and Documentation of Applesoft Programs

This 3 program set is a must to anyone writing or using programs in Applesoft! It not only provides valuable info. on each of your programs, but allows you to change any element throughout the listing almost as easily as you would change a single line!!

With Apple-Doc you can produce a list of every variable in your program and the lines each is used on, each line called by a GOTO, GOSUB, etc., in fact, every occurrence of almost anything! You can rename variables, change constants and referenced line numbers or do local or global replacement editing on your listing.

Apple-Doc is a must for the serious Applesoft programmer.

Diskette complete with full documentation £24.95 + VAT

tridee

©Robin L. Frost

An exciting new addition to your Pascal library — enables you to create 3D graphics, viewable from any angle and distance. As easy to use as Turtlegraphics.

Procedures include Ortho, Perspec, Rotate, View, Move to-3, View-from.

Complete with comprehensive instructions £49.95 + VAT

Animations & Simulations

© A. Rowe

A teaching aid, used to illustrate algebra and statistics. Makes full use of the Apple's high resolution graphics.

Apple disk £29.95 + VAT

Plus a complete range of "off the shelf" programs for finance, commercial, scientific and education. Keep yourself up to date, send for our "Fact Sheets" giving full program details.

LEICESTER

computer centre limited

109 QUEENS ROAD LEICESTER LE2 1TT

Tel: 0533 709841

apple computer
Sales and Service

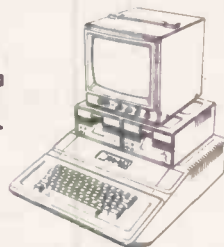

•Circle No. 319

THE
PAPER
SHACK

SUPPORTS PAPER USERS

With sensible prices..

RULED
14½" x 11" = £6.00
INC. P & P

PLAIN
9½" x 11" = £6.00
INC. P & P

For sensible minimums..
of 500 sheets continuous stationery.
Details of other sizes, self adhesive
labels etc:-



01-642 8971

THE
PAPER
SHACK

• Circle No. 320

Wilkes Computing Announce The VISUAL 200

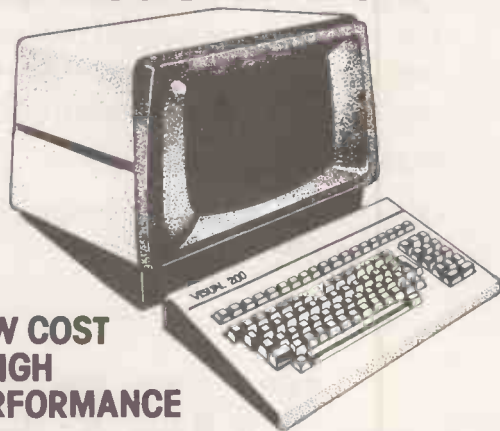

LOW COST
— HIGH
PERFORMANCE

- Detachable keyboard
- Numerical pad
- Upper & lower case
- Editing
- Smooth scroll
- Cursor addressing
- Printer port
- Many more standard features and options
- Switchable emulations
DEC VT52
Hazeltine 1500
Lear Siegler ADM3A
ADDS 520

Wilkes Computing

Bush House, 72 Prince Street, Bristol BS1 4HU

Tel. (0272) 25921 Telex. 449205

•Circle No. 321

What will you do with 12-year-old programmers when they reach 16?

Any microcomputer is a major investment for an educational establishment. Many potential users feel that a BASIC only computer is ample for their needs. That may be fine today, but with computer education starting so early you may in a surprisingly short time find you want more than current implementations of BASIC.

The 380Z is a computer that can grow to match your needs.

In the design of the 380Z our target user is the graduate research scientist. This ensures that the expandability and versatility needed tomorrow has been provided for in the computer you buy now.



Might you want to add disc storage in the next few years?

If you do:

Given good hardware, software availability completely determines the flexibility and usefulness of your system. There is absolutely no question that a Z80 based micro-computer which uses the industry-standard CP/M* disk operating system has several times more software on the market available to it than non CP/M computers.

Today you can purchase a mature CP/M BASIC, FORTRAN, COBOL or Text Processor for the 380Z. Soon there will be CP/M Pascal and Database Management systems.

CP/M software is several years ahead of software available for non CP/M family machines.

If you don't:

Remember that professionals writing packages for your cassette system will themselves often use a disk 380Z, and the power of their tools will influence what they produce.

For many people a disk machine is too expensive - but at least the 380Z

approach will allow your students to advance.

380Z BASIC is not frozen in ROM. An enhanced BASIC could be loaded in mid 1980 and a BASIC with structured features sometime later.

On the 380Z the memory used by a BASIC interpreter can also be used for other software.

Does our research-oriented design pay off in classroom hardware?

Our scientific graphics was produced for the professional user. Interest in it for classroom use has been surprising.

The 380Z has the best graphics now available on a microcomputer,

allowing multiple resolutions, multiple paging, fading and accurate control over colour. All these features help bring excitement to efforts in computer assisted learning.

Our standard machine comes with low resolution graphics and support for this from BASIC allows you to plot a point directly with a plot command - useful for training and teaching.

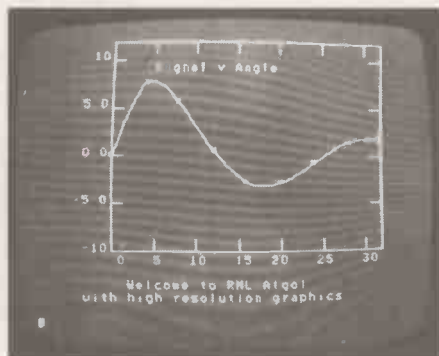

It is worth remembering too that neither our low resolution graphics nor our optional scientific (high resolution) graphics has any limiting effect on your memory usage, and in both you can



freely mix upper and lower case text and diagrams.

Mains noise can cause system crashes which result in loss of programs and data. All current 380Zs include a mains filter which significantly reduces the chances of this happening.

Don't buy a 380Z on patriotic grounds.

Please only buy it if you would have bought it anyway. But remember, because it is designed and manufactured here you are bound to have better access to us for influence and help than if we were on the other side of an ocean.

Prices range from a 16K cassette 380Z @ £897 to a 56K Dual Full Floppy Disk 380Z @ £3322.

LOWER COSTS

Three things have happened which make it easier to buy a 380Z.

ONE: From 1st November 1979 most prices have been reduced.

TWO: Schools and some colleges can now get a 5% discount on computer orders.

THREE: A new Local Authority quantity discount scheme has been introduced to make it easier for more users to benefit from quantity purchasing.

Please contact the Sales Office for details.

RESEARCH MACHINES

RESEARCH MACHINES Ltd,
PO. Box 75, Mill Street, Oxford, England.
Telephone: Oxford (0865) 49791/2/3.
Please send for full sales information.
Prices do not include shipping costs or VAT @ 15%.

*Trademark, Digital Research.

• Circle No. 322

GATE MICROSYSTEMS LIMITED

SCOTLAND'S COMPLETE MICROCOMPUTER SERVICE



Announce:

SUP'R'TERMINAL

SUP'R'TERMINAL IS AN 80 COLUMN BY 24 LINE PLUG-IN COMPATIBLE BOARD FOR THE APPLE II COMPUTER

SPECIFICATIONS

- 80 Columns by 24 lines, upper and lower case; all 128 ASCII characters.
- Upper and Lower case data entry using the APPLE II keyboard.
- Includes an Upper and lower case 5x8 dot matrix ASCII character set, and inverse alpha characters.
- Character set can be user definable
- Includes VBC™ (video balance circuit) which enables the use of displaying 80 columns on an inexpensive 8 MHz CRT monitor
- Shift Lock Feature
- Works with APPLE PASCAL and APPLE BASIC
- Incorporates PASCAL and BASIC control characters
- ALL monitor-type escapes are valid
- Follows protocols of PASCAL and BASIC operating systems
- Compatible with ALL APPLE II peripherals.
- Effective baud rate greater than 10,000; fast scrolling and clearing
- Synchronous operation with APPLE II
- Can be used with APPLE II communication interface board to act as self contained terminal for time-sharing or other applications.

£245.00
Ex VAT.

GATE MICROSYSTEMS LIMITED
THE NETHERGATE CENTRE, 66 NETHERGATE, DUNDEE
TEL: (0382) 28194

•Circle No. 323



centralex

CENTRALEX-LONDON LTD
8-12 Lee High Rd, London SE13
Tel: 01-318 4213/4/5/6/7
9.30 am - 5 pm Mon to Fri -
Evenings and weekends by
appointment

A comprehensive range of Microcomputers Equipment, Peripherals, Software and Services for those who value Professional Standards, Guidance and Continuing Support for Hardware and Software.

APPLE
TEXAS
MICROPOLIS
DIABLO
MICROLINE

PET
OHIO SCIENTIFIC
CENTRONICS
QUME
HITACHI

ITT 2020
CROMEMCO
ANADIX
DEC
LEXICON

EXIDY
MICROSTAR
INTEGRAL
DATA GENERAL
ETC. ETC.

HORIZON
SHUGART
TELETYPE
EPSON

INFORMEX-80 Printer



£399+VAT

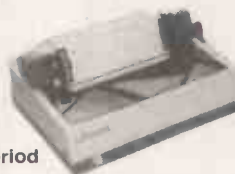

Special offer - for a limited period

For PET, APPLE, EXIDY, TRS80, ETC
A high quality, high speed printer
(125 cps) Upper and lower case letters
plus graphics as standard
Interface and cable for TRS80, PET,
APPLE or RS 232 £69 + VAT
Tractor feed option only £39

ALSO Training, Consultancy, Systems Design,
Programming and Software

PAYROLL - INVOICING - STOCK CONTROL -
SALES/PURCHASE LEDGER - VAT - MEDICAL
RECORDS - EDUCATIONAL & ENGINEERING
PROGRAMMES - HOTEL RESERVATION - ESTATE
AGENTS - BUILDING MAINTENANCE - COBOL -
FORTRAN - ETC.

Maintenance Contracts including stand-by equipment during repair periods - Free Delivery Nationwide - Terms arranged - Credit Cards and official orders accepted.



•Circle No. 324

BIRMINGHAM COMPUTER CENTRE

COMPLETE BUSINESS SYSTEMS FROM THE PROFESSIONALS

3000 SERIES

8K with built-in cassette
 8K with professional keyboard
 16K with professional keyboard
 32K with professional keyboard
 343K Twin Floppy Disk
 CN2 Cassette Deck
 IEEE Cables — Pet
 IEEE to IEEE
 Tractor Feed Printer

£
 425
 450
 550
 695
£695
 55
 20
 25
 425

COMMODORE OFFICIAL DISTRIBUTOR



32K SYSTEM COMPLETE £1850

NEW 8000 SERIES

8032 — 32K with 80 col Screen
 8050 — Twin Disk Drive 950K

£
 895
 895



Latest Apple II
 with Auto-Start Rom
 and Floating Point
 Basic.

48K + Disk Drive
 with Controller.

£1044
 + VAT



16K
 Disk Drive with Controller
 Disk Drive without Controller
 Eurocolour Card
 Pascal Card
 Centronics Type Inter
 16K Upgrade
 Monitor
 Full Range of Software Available

£
 695
 349
 299
 69
 299
 110
 69
 115

SHARP MZ 80K



48K **£550**
 + VAT

A complete Personal Computer System.
 At an Economical Price

£
 20K 480
 32K 529
 36K 549
 48K 599
 Hi-resolution monitor.
 Fast cassette unit.
 Extensive graphics plus
 Built in sound GEN.

Widely accepted as the most powerful
 8-bit cpu on the market.
 Floppy disk drive now available plus
 printer.

NEW MODEL: BD-80P THE NUMBER 1 HI-SPEED PROFESSIONAL MATRIX PRINTER.

Now with graphics plus 10 user
 defined 750K Buffer Standard
 with further 2K option
 RS232
 Serial.
 or parallel interface
 plus numerous advanced
 features.



NEW-LOW—PRICE

£475

THE ULTIMATE IN DAISYWHEEL PRINTERS

RICOH.RP 1600

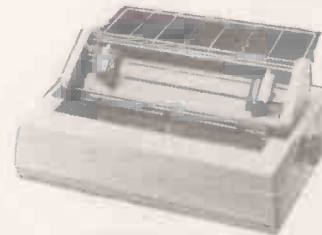

£1490

THE BEST WORDPROCESSOR. PRINTER. AVAILABLE
 DEALER ENQUIRIES WELCOME

IF IT'S THE BEST WE STOCK IT

Complete range of — Off the Shelf Programs from the best in
 the country including:
 Commodore — Full range of Business Programs.
 Act — Complete range available
 Bristol Software Factory. Trader-Item-Monitor
 Computastore — Payroll
 Gramma-Winter — Complete Suit of Programs

Full range of Books and Magazines
 C15 — Super Quality Data Tapes Boxed 10 — £5.00
 Disks certified 5 1/4" Boxed 10 — £30.00
 Printer Ribbons — Listing Paper — Mailing Labels —
 Dust Covers, etc.
 Commodore 3032/16. Disk operating systems in
 ROM.

* SPECIAL PRICES FOR BETSI — KIMSI — MOTHERBOARDS — KIM.1. — PHONE FOR PRICE *

SHOWROOMS OPEN DAILY. 9—6 P.M.
 LARGE CARPARK ADJACENT.

DEMONSTRATIONS AT YOUR CONVENIENCE.
 SALES • SERVICE • SATISFACTION



CAMDEN ELECTRONICS
 462 COVENTRY ROAD
 SMALL HEATH, BIRMINGHAM B10
 021-773 8240 — 021-772 5718



HP
 LEASING
 ETC

• Circle No. 325

Introducing the

INFODISK FILE MANAGEMENT SYSTEM FOR THE COMMODORE COMPUTER SYSTEM

At last a program system that will do what you want, the way you want it, at a remarkably low price. There is no need to buy separate programs for each application. The one system enables you to create an unlimited number of applications. Do all your accounting, stock control, payroll, file management and information retrieval etc., the way you understand, with this one system, for one price. It is possible to do almost all conceivable business applications with this simple to use system.

It features among other things:—

- 1.) Data validation — 8 data types.
- 2.) Variable length fields and records of any size.
- 3.) Automatic calculations and updating of individual fields, records and whole file.
- 4.) Linear and tabular reports of all kinds, for all records satisfying any conditions.
- 5.) Powerful search capability; numeric; alphabetical and date comparisons, conditional expressions however complex whatever you want 'INFODISK' can find it.
- 6.) Sort facilities to sort files in any order or any field.

'DISK' £130.00p. + V.A.T. plus 50p. Packing & Postage
for 16 and 32K Computers.

'TAPE' £ 40.00p. + V.A.T. plus 50p. Packing & Postage

MAIL ORDER — CHEQUE WITH ORDER TO: —

A.J.R. OFFICE EQUIPMENT SERVICES LIMITED.

80 NOTTINGHAM ROAD, ARNOLD, NOTTINGHAM NG5 6LF. TELEPHONE 206647 (0602)

Please supply Item

Quantity

Name

Address

SPECIAL OFFER ON SHARP M280K COMPUTERS/PLEASE TELEPHONE FOR PRICE

PC10

•Circle No. 326

PAYROLL 'PLUS'

£150 plus VAT

This must be the finest plain paper payroll available for the CBM PET.

It is designed to the Inland Revenue Specifications for Computerised Payroll. It uses plain computer paper throughout and so avoids the need for expensive pre-printing and the annoyance of having to change the paper for specific uses.

Included in its coverage is the following: ALL Tax Codes. ALL NI Codes. Hourly, Weekly and Monthly paid staff — and mixed on the same file disk. 3 rates of overtime which can be entered as amounts or as percentages for hourly staff. 5 Pre-tax adjustments — 2 of which may be pre-set to avoid re-entry each payday. 5 After tax adjustments — again 2 of these may be pre-set. Easy manipulation of employee data — under a security password (which may be changed). Listing for P35. Will handle up to 500 employees on one data disk — and all can be current. Employee deletion without affecting totals.

Four choices of payroll run method: (1) Payslip print-out after each entry. (2) All entries made first, then continuous print run. (3) Immediate payslip print run without entries — if payroll is suitable. (4) Select individual employees.

Payslips are very comprehensive and easy to read and payslips and copies are printed side by side so that the employers copies may be kept in a continuous strip. The extra NI figures required for Contracted-Out employment are printed.

An analysis after the pay run gives Taxable Pay, Employers NI, Deductions and Totals — in other words, the actual cost of the employment and this is in up to 26 separate groups. These are followed by the total Overtime hours for each of the 3 rates, then the full combined totals and a Cash Analysis.

Landsoft Payroll Programs are in use by a considerable number of Accountants and are known for their simplicity of operation and 'User Friendliness'.

HOTEL GB

£350 plus VAT

This fast elegant program is the answer to the hoteliers dreams. It makes the invoicing of guests for their accommodation and services extremely easy. No longer the chore of entering all the accommodation charges every night, the computer does it automatically. At the touch of a few keys a guests account to date can be displayed and the bill printed with a copy for the hotel.

Daily and period totals for 22 service items can be had whenever required. Also grand totals, Total debt to hotel. Items deleted from accounts. Payments in cash. Payments by five different credit cards. Deposits etc.

Hardware and Software will cost little more than half the price of a custom guest billing machine — and the computer gives the ability to do Payroll, Stock Control and General Accounts.

SUPERIOR PROGRAMS FOR THE 32K CBM AND CBM DISK

LANDSLER SOFTWARE 29a Tolworth Park Road, Surbiton, Surrey. 01-399 2476/7



•Circle No. 327

Introducing PEARL



Product of:
Computer
Pathways
Unlimited, Inc.

**A Powerful Application Generator
Produces Error-Free Automatic Rapid Logid
Generates C BASIC 2 Programs and Compiles Them**

Automatically Produces Programs For:

| | | |
|-----------------------------|-----------|------|
| Menu Selection | Level I | £90 |
| File Update/Edit | Level II | £325 |
| Report Generator | Level III | £625 |
| Indexed File Reorganisation | | |
| Indexed Access | | |

All Prices Exclude V. A. T.

Contact UK Distributer — Tel: 01-670 4202

Clenlo Computing Systems Ltd
Crown House
18 Gypsy Hill
London SE19 1NL



THE CLENLO CONQUEROR



A Z-80 Microcomputer in an attractive Metal Cabinet, containing a 12 slot motherboard. Two serial and two parallel I/O ports are standard. Will accept a variety of S-100 compatible floppy and hard disc Drives.

| | |
|---------|---------|
| 16K RAM | 650.00 |
| 32K RAM | 805.00 |
| 48K RAM | 960.00 |
| 64K RAM | 1115.00 |

| | |
|--|--------|
| 8" 500K Double Density Floppy Disc Drive and Controller. | 700.00 |
| Add On Unit | 410.00 |

All prices exclude VAT

**Clenlo Computing
Systems**

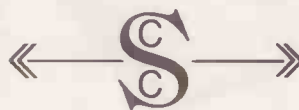

Crown House
18 Gypsy Hill
London SE19 1NL
01-670 4202

• Circle No. 328

ANDREWS COMPUTING LTD

TRS - 80 NASCOM 1 & 2

Now there is a range of quality software at real value for money prices.

For TRS-80 Level II (16K+)

PASCAL Development System £18.00

Pascal Compiler
Run Time P-Code Interpreter
Compiler source code (in Pascal)
Pascal Guide

Take a step into the future with this exciting product, which runs many times faster than Basic.

BASIC III - The Level III Basic £18.50

Extended High Speed Graphics
Renumbr Basic Programs
Append Basic Programs
Single key entry of Keywords

Includes many features of Disk Basic and a superb demonstration program.

GAMES Tape No. 7 £7.50

33 Programs (Excellent Startrek)

R-BUG Machine Code Monitor £8.50

All standard monitor facilities
Enables System Tapes to be copied for backup purposes.

For NASCOM 1 & 2

RENUMBER Nascom Basic £6.00

Renumbers Microsoft/Starbase (ROM or Tape) Basic. Available for T2, B-Bug, T4 and Nas-Sys monitors

For further details of our extensive range, send for free catalogue. All prices include VAT and P & P. Please state computer type when ordering.

ANDREWS COMPUTING LTD
21 Lime Tree Drive, Farndon, Chester

• Circle No. 329

CP/M Software
Superbrain/
Dynabyte
Cromenco - Etc.

Dealer Enquiries
Welcome



Glyn Rigby, Manchester. Tel: 061-633 3084/5

Denis Thomson, Leeds. Tel: 0532-445234

Bill Hendry, Glasgow. Tel: 041-204 1297

Nominal Ledger
From £300
Payroll £350

**Job Costing/Order
Control £550**
Incomplete Records
£550

• Circle No. 330

apple® computer

Sales and Service

16K Apple £695
+ VAT and carriage

We also supply • Lear Siegler ADM3A — £515 for one.
£500 each for two or more.



• Verbatim
Single-sided minidiskette — £23 per box of 10.

— £21 for two boxes or more.
Double-sided 8m. diskettes — £40 per box of 10

— £38 for two boxes or more.

Carriage inclusive, VAT extra.

We are also a Cromenco dealer supplying turnkey packages for Estate Agents, Solicitors and Wholesalers.

Total Concept Systems Ltd

373 High Road Leyton, London E10. 01-539 7194 (day) 01-554 1152 (eve)

• Circle No. 331

DATA LINK

Microcomputer Systems Limited

Systems software for business, industrial and scientific applications

APPLE SYSTEMS

| | |
|------------------------------------|---------|
| Apple II Plus 16K | £695.00 |
| ITT 2020 16K (with colour) | £705.00 |
| Disk Drive with controller card | £349.00 |
| Disk Drive without controller card | £299.00 |
| 16K Add-ons RAM | £69.00 |

FULL RANGE OF ACCESSORIES

| | |
|-----------------------------|---------|
| including: -- | |
| Visicalc | £95.00 |
| ALF Music Synthesizer | £135.00 |
| A1-02 Data Acquisition Card | £180.00 |
| Clock Card | £160.00 |
| ROM Plus Board | £116.00 |



ALL PRICES EX VAT

APPLE SYSTEM — Latest Additions

| | |
|---|---------|
| DOS 3.3 (23% extra disc space) | £39.00 |
| H.S. RS232/Bi-directional parallel Combined Interface | £120.00 |
| Desktop Plan (from Visicalc people) | £64.00 |
| H.S. Serial Interface | £80.00 |
| Language Card with Pascal | £299.00 |
| Fortran addition | £120.00 |
| Pilot addition | P.O.A. |
| Appletel (for Prestel) | £595.00 |
| Apple juice reserve power supply | £148.00 |
| IEEE Interface | £212.00 |

Printers

| | |
|--|-----------|
| Paper Tiger (with graphics) | £598.00 |
| Centronics 737 (5 character sets. Bi-directional paper drive. R. Margin justification) | £580.00 |
| Centronics 701 | £1,115.00 |
| Centronics 702 | £1,310.00 |
| Centronics 703 | £1,625.00 |
| Centronics 704 | £1,655.00 |
| Centronics 753 | £1,655.00 |

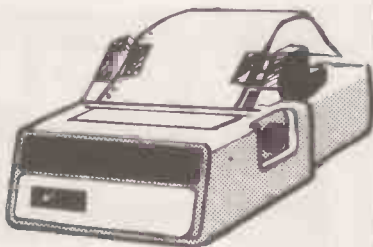

SOFTWARE

We have second to none programming facilities, both in-house and through an associated Company: Management Services and Systems Ltd. All our programs are original and fully guaranteed E.G.
 Mailing List £50 Stock Control £200
 Integrated Accounts Package £800 (Sales/Purchase/Nominal Ledgers/Invoicer)
 Sales Management Package £400
 Critical Path Analysis POA Contract Estimating POA
 Programs are written for both the Apple and Image Data systems. They can be tailored to meet a customer's particular requirements.

DISKETTES ETC

| | |
|--|--------------------|
| BASF Top Quality Unconditional 12 Month Guarantee | |
| 5.25" Mini Single Sided Soft Sectored/Single Density | £25.00 (Box of 10) |
| 5.25" Mini Single Sided Hard Sectored/Single Density | £25.00 (Box of 10) |
| 5.25" Mini Single Sided Soft Sectored/Double Density | £26.00 (Box of 10) |
| 5.25" Mini Double Sided Soft Sectored/Double Density | £30.00 (Box of 10) |
| 8" Single Sided Soft Sectored/Single Density | £26.50 (Box of 10) |
| 8" Single sided Soft Sectored/Double Density | £27.50 (Box of 10) |
| 8" Double Sided Soft Sectored/Single Density | £40.00 (Box of 10) |
| 8" Double Sided Soft Sectored Double Density | £40.00 (Box of 10) |

DISKETTE LIBRARY CASES

| | |
|---|-------|
| 5.25" Mini Diskette Library Case for 10 Diskettes | £2.50 |
| 8" Diskette Library Case for 10 Diskettes | £3.00 |

DISKETTE TRAY WITH LOCKABLE LID

| | |
|--|-----------------------|
| A6 5.25" Mini Diskette Tray with Lockable Lid: | 30-40 capacity £18.00 |
| | 60-80 capacity £20.00 |

| | |
|--|-----------------------|
| A5 8" Diskette Tray with Lockable Lid: | 30-40 capacity £25.00 |
| | 60-80 capacity £28.00 |
| | £16.00 |

9" Plain Listing Paper (per 2,000 sheets)

10% EDUCATIONAL DISCOUNT

STOP PRESS

Programmable Timer for Apple

Software controlled counter/timer for frequency/interval measurement, pulse/event counting, controlled frequency source, etc. 6 input/output channels. 16 bit counter resolution, 2M sec max clocking frequency. Remote stop/start.

£110.00

Z-80 Softcard for Apple

You've read about it, we can supply it. Send for full details and specification.

£180.00

We also stock an extremely comprehensive range of computer books

DATA LINK

10 Waring House, Redcliffe Hill, Bristol BS16TB
 Telephone: Bristol (0272) 213427

SOFTY Software Development System AND EPROM PROGRAMMER **EX-STOCK**

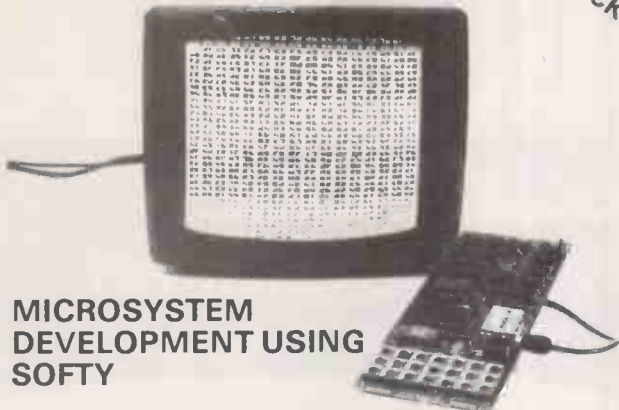

MICROSYSTEM DEVELOPMENT USING SOFTY

SOFTY is intended for the development of programs which will eventually become software residing in ROM and forming part of a microsystem. During the development stage of a microsystem, SOFTY will be connected in place of the firmware ROM via a ribbon cable, terminated in a 24 pin DIL plug. Data may be entered into the SOFTY RAM via the serial port, parallel port, direct memory access, or the keypad, and manipulated using the assembler key-functions. When the program has been entered, and the internal microprocessor can be 'turned off', and the external microsystem and its resident microprocessor allowed to access and run the program in SOFTY's RAM and/or programming socket. In this way, modification can be made until the required program is complete — the contents of the RAM being clearly visible as a 'page' on TV or monitor. 4 pages are available, 2 of the Data RAM and 2 of the programming socket. In the end, when the program is complete and working, the DIL plus is removed and replaced by an EPROM device programmed by SOFTY. SOFTY is able to program the 2704/2708/2716 family which have 3 voltage rails — To help in the process of program development SOFTY has various assembler key-functions, which include — block shift without overwriting, block store, cursor control, match byte and displacement calculations (for jumps etc). A high speed cassette interface is also provided for storing working programs and useful subroutines. SOFTY Kit-of-parts: (including zero insertion force socket for EPROM programmer) Price £115 (inc VAT, p&p). SOFTY built and tested — £138:00 (inc VAT, p&p). Built SOFTY power supply — £23:00 (inc VAT, p&p). Write or telephone for full details.

NEW

SOFTY CONVERSION CARD — EX-STOCK
Enables SOFTY to program the single rail EPROMs 2508, 2758, 2516, (INTEL 2716), 2532.
Selection of device type and 1K block are by 4 way pcb slide switches. Programming socket is zero insertion force. Supplied ready built & tested with Dip jumper for connection to SOFTY. £46:00 (inc VAT, p&p).

NEW

SOFTY PRINTER CARD — EX-STOCK
• 40 column electrosensitive printer • 5 x 7 dot matrix
• software selection of characters per line (1 to 16 bytes)
• push button printing of EPROM/RAM/Intercursor contents
• Connects to SOFTY card edge • Well documented • Supplied ready built & tested, including power supply, edge connector & paper roll for £166:75 (inc VAT, p&p) Spare paper rolls (28-30metres/roll). Four rolls for £8:00 (inc VAT, p&p).

MODEL 14 EPROM ERASERS **EX-STOCK**

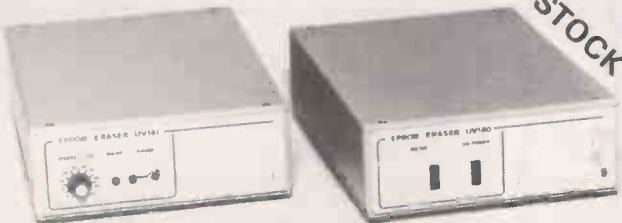

MODEL UV 141 EPROM ERASER
• Fast erase times (typically 20 minutes for 2708 EPROM)
• 14 EPROM capacity
• Built-in 5 to 20 minute timer to cater for all EPROMs
• Safety interlocked to prevent eye and skin damage
• Convenient slide-tray loading of devices
• 'MAINS' and 'ERASE' indicators
• Rugged construction
• Priced at only £89.70 (inc VAT, p&p)

MODEL UV 140 EPROM ERASER
Similar to Model UV141 but without timer
Low price at only £70.73 (inc VAT, p&p)
WRITE OR TELEPHONE FOR FULL DETAILS OR SEND CHEQUES/OFFICIAL COMPANY ORDERS TO:

GP Industrial Electronics Limited

Skardon Works, Skardon Place, North Hill, Plymouth
PL4 8HA. Telephone: Plymouth (0752) 28627
TRADE AND EXPORT ENQUIRIES WELCOME

• Circle No. 333

Main London Sorcerer Stockists EMG 01-688 0088

We are specialists in complete installations tailor made for your business requirements:

| | |
|--------------------------|-------|
| WORD PROCESSING SYSTEM | £1999 |
| ESTATE AGENT SYSTEM | £2999 |
| LEADS AND SALES SYSTEM | £2999 |
| INSURANCE AGENT SYSTEM | £2999 |
| AGENCY SYSTEM | £2999 |
| COMPLETE BUSINESS SYSTEM | £3999 |

For the Sorcerer Specialist:

Sorcerer Systems Desk
Mains Stabilisation
Cooling Fan
Memory Upgrades
Servicing Undertaken
WP Correspondence Course
Link your Sorcerer to another Sorcerer
Link your Sorcerer to a Main Frame
Full software list on request

6 COPIES OF SOURCE MAGAZINE ONLY £5
Write to Dept PC9, EMG Microcomputers Ltd,
30 Heathfield Road, Croydon, Surrey.

• Circle No. 334

a digitizer adds another dimension

The Bit Pad computer digitizer converts graphic information into digital form for direct entry into a computer. By touching a pen like stylus or a cursor, to any position on a drawing, diagram, photograph, or other graphic presentation, the position co-ordinates are converted to digital equivalents.

- Bit Pad interfaces with almost any micro computer.
- Bit Pad consists of a 15" sq. digitizer tablet (11" sq. active area), a stylus, and a controller cabinet.
- Bit pad costs only £532 (inc RS232) excluding VAT

Fill in the coupon and we will send you full information and details



Terminal Display Systems Ltd

Hillside, Whitebirk Estate,
Blackburn, Lancs BB1 5SN
Telephone (0254) 662244
Telex 63162 TDS G

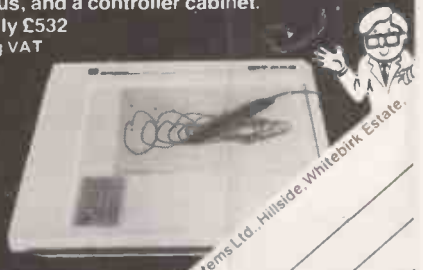

Send to Terminal Display Systems Ltd, Hillside, Whitebirk Estate,
Blackburn, Lancs. BB1 5SN

Name _____ Address _____



• Circle No. 335

TRS-80 owners!! Double Disk Capacity with the Phantom Double-Density Module

Provides double density modification to your current TRS-80 Expansion interface

Increases storage capacity up to 204K bytes (on single 40 track drive.)

Includes all hardware and software.

£165



Load TRS-80 programmes & data Fast! with the Phantom Disk Drive system

*23% more storage capacity than TRS-80
*40 track patch at no Extra charge.

Two drive system £495
Four drive system £935
Two drive cable £20
Four drive cable £30



Single drive system

£265

The only 16k complete computer for under £400

Keyboard computer, power supply, UHF modulator and all cables to plug into your own TV set and cassette recorder and go!!

16K of user RAM for decent size programmes and data, sophisticated level II Microsoft BASIC.

Complete with level I and level II programming manuals. What more could you ask?



**TRS-80
£382**

Expansion interface £199.09
4K level I computer £251.30

This lot must be today's best buy!



Galaxy 2000 by Compu/Think

(.8 Megabyte Disks) £2,950
(2.4 Megabyte Disks) £3,960

SPECIAL - GALAXY prices include Compu/Think Pagemate Database and Report Writer at no charge

The most advanced complete microcomputer system available.

Includes CPU, 12" CRT, full keyboard, 2 quad-density disk drives, 2 megahertz 6502 hybrid processor (double speed), 108 K system memory, high resolution (512 x 240) graphics, programmable character fonts, microsoft extended BASIC, DOS with random access I/O, full complement of I/O ports, monitor with debug, trace and tiny assembler, fifth (PL/M and fourth combination) interpreter, complete editing and entry with split screen capability, 64 microprogrammable opcodes, business software (with Database) available.



2001-8N
(8K RAM New large keyboard)

£425

NEW 80-Col.
32k £825

Super-Pets are here! 40 & 80 COLUMN

Now you can

list unlistable programmes using the 6502 non-maskable interrupt facility! — just hit the new 'abort' button to jump out of programme into command mode

recover from crashes without switching off — just hit the new 'reset' button.

add sound to your programmes!

The hardware is built-in — just write sounds into your programme using our simple directions.

2001 - 16N (16K RAM and new large keyboard) £550

2001 - 32N (32K RAM and new large keyboard) £690

External cassette deck, suitable for all Pets £53

CBM dual drive mini floppy £695

Tractor feed printer with Pet graphics £395

Pet high-res. graphics 200 x 320 £259

Get into print this easy way!



Anadex DP 800 dot-matrix printer

*Speedy 112 ch/s bidir.
*Fits A4 page-up to 80 cols.
*Up to 4 copies. *Precision form-filling with sprocket feed. *Special headings using double-width chars. *Modern paper format to match A4 filing systems. *Other paper sizes with adj. sprocket.
*Full punctuation, U/L case, £ sign, 96-ch. set.
*Reliable — strongly built. 100 M.ch. head.

Knock down price!

£499

Interfaces and cables —
Pet £45 Ohios £30
TRS-80 £40 Sorcerer £25
Apple £69



IBM golfball printer ideal for word-processing

*Forget expensive Spin-Wheel printers — the Golfball produces equal quality at up to 15 ch. per sec. *Match various typewriter styles with IBM interchangeable heads. *Completely reliable — each machine rebuilt by IBM trained engineers and fully guaranteed. *Precision form-filling possible with 15 in. pin-feed platen.

Non-keyboard version

£595

Keyboard version £695 (illus)
Interfaces and cables —
Pet £45 Ohios £63
TRS-80 £35 Sorcerer £25
Apple £69



Phantom 400/800 Thermal Printer

*Stop disturbing others with noisy printout! *Neat, clear, 96-ch. set, U/L case & symbols, in text mode.
*Fast, 48 ch/s bidir. *Reliable — robust — only two driven parts.
*Plug in and go, built in PSU, detailed manual. Thermal paper in 80 ft rolls less expensive than electro-sensitive paper and now — dot hyphen addressable graphics too!!

For only A snip!

£249 (40 col)

80 col model (800) £359
Interfaces and cables —
Pet £45 Ohios £63
TRS-80 £40 Sorcerer £25
Apple £69

Up to 1.6Mb for PET!

and 'on-line' with the CompuThink Disc System

*Allows powerful business programmes using 16 Extra BASIC commands. *Easy to connect and use — plugs directly into 16/32K PETs, detailed manual supplied.
*Simple startup (no difficult procedures to remember) as Disc Op. System in ROM. *Ready to run — useful programmes supplied free; full set of professionally written business packages available — Sales and Purchase Ledger, Stock Control, Payroll etc., *Real-Time processing, Engineering and Commercial boundaries overcome with full language support — Business BASIC, Assembler, FORTRAN, COBOL, PASCAL, FORTH, FIFTH, PLM, PILOT & CESIL.

24K Memory expansion with dual disc for old ROM 8K PET £275
for new ROM 8K PET £320



Basic 400K
dual disc
system

only

£840

800K £1,095
1.6 Mb £2,190

You can afford to start computing now!

Fully tested complete
with 4K RAM.
Extra 4K RAM £35

£220

*Powerful programming possible — 6502 processor, fast 8K Microsoft floating-point BASIC (easy to learn). Superior utilities, 53 key key-board, giving upper and lower case, user-definable keys, gaming and graphics chs. Ultra-fast and powerful machine code from keyboard.

*No intricate soldering or metal work. Computer supplied assembled in ready-made case. *Reasonable sized

programmes in 4K RAM. *Expandable to 24K RAM in case, drives discs, printer, available items include Assembler/Editor and Extended Monitor. *Programme interchangeability/reliability — Kansas City tape interface. *Save programmes on own cassette recorder — all cables supplied.



at a lower price
than equivalent kits

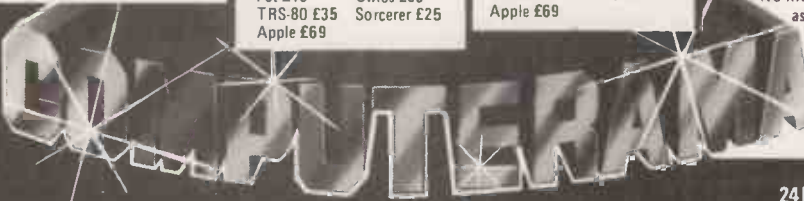

your dealer for Bath, Bristol and S.W

Tel: Bath (0225) 333232

5 Cleveland Place East, London Road, Bath, BA1 5DJ.

Special terms available for educational and government establishments — dealer enquiries invited.

24 hr ordering service

Full after-sales
service in our
own workshops

One year guarantee
on all new machines



Please
add £10
Securicor
delivery on
computers etc
plus 15% VAT
on all prices

• Circle No. 336

**£1150
+ VAT**

VISUAL 100



The VISUAL 100 is a new microprocessor based video display terminal that offers total compatibility with the DEC VT100* from both a software and operator point of view.

For the operator, the detached solid-state keyboard has been customized so that all key positions and LED indicators are in identical location to that of the VT100.

For the software, all codes and features have been implemented in a manner identical to the VT100 assuring plug-to-plug compatibility.

The big difference between the VISUAL 100 and the DEC VT100 is that the VISUAL 100 offers features not available on the VT100, or available only as extra-cost options. These added features include:

- **ETCHED NON-GLARE FACEPLATE**
Your operator will appreciate viewing characters through an etched non-glare faceplate. This feature assures crisp, sharp character resolution even in the brightest office environ-

ments. Further, the tilt screen feature allows an adjustable viewing angle, 10° to 15°, for optimal viewing comfort.

- **ADVANCED VIDEO PACKAGE IS STANDARD**
Blink, bold, reverse video, and underline video attributes which can be used alone or in any combination for enhanced video presentations.
- **CURRENT LOOP INTERFACE IS STANDARD**
A 20mA current loop interface as well as an EIA RS232C interface.
- **BUFFERED PRINTER INTERFACE OPTION**
This option allows independent print/communication baud rates and independent parity. The printer option also allows the VISUAL 100 to function as a controller between host and printer, using "XON XOFF" protocol. Printer busy can also be monitored using XON XOFF, or control line.

Seeing is believing, so see for yourself. For a demonstration and a pleasant surprise on quantity pricing of the VISUAL 100, call or write us today.

• Circle No. 337

**£675
+ VAT**

VISUAL 200



The VISUAL 200 is a new, low cost, microprocessor based video display terminal which truly stands above competitive teletype compatible terminals in its price range.

In addition to the most popular features available (or partially available) on competitive terminals, such as numeric pad, upper/lower case, editing, current loop, cursor addressing, columnar and field tab, etc., standard features which set the VISUAL 200 apart and reach the optimum in human engineering and operator comfort include:

- Detachable Keyboard
- Smooth Scroll
- Tilt Screen (10° to 15° viewing angle)
- Large 7 x 9 Dot Matrix Characters

Perhaps the most distinctive feature of the VISUAL 200 is the Switchable Emulation capability. A switch on the rear panel programs the terminal for code-for-code emulation of a Hazeltine 1500, ADDS 520, Lear Siegler ADM-3A or DEC VT-52. To an O.E.M. customer it means no change in software to displace the older, less powerful terminals in his product line with the new, reliable and low cost VISUAL 200. To a Distributor it means offering a single modern terminal which is compatible with all the software his customers have written for the older terminals. And you're not limited to merely emulating these older terminals; you can outperform them at the same time by taking advantage of the additional features of the VISUAL 200.

Reliability designed into the VISUAL 200 is evidenced by its solid state keyboard, single P.C. Board and self test diagnostics on power up.

Seeing is believing, so see for yourself. For a demonstration and a pleasant surprise on quantity pricing of the powerful, easy to use and reliable VISUAL 200, call or write us today.

Standard Features

- 24 x 80 Screen Format
- 7 x 9 Dot Matrix
- Upper/Lower Case
- Numeric Pad
- Background/Foreground
- Blink Line
- Insert/Delete Line & Character
- Columnar and Field Tab
- Set/Clear Tab
- Security Mode (non-display)
- Clear End Line, Field & Page
- Clear Line
- Clear Screen
- Line Drawing
- Current Loop or RS-232 Interface
- Secondary Channel
- Composite Video
- Serial Copy Port
- Hold Screen
- Baud Rates to 19,200
- Self Test
- Cursor Addressing
- Cursor Control Keys
- Read Cursor Address
- Typamatic Keys
- Smooth Scroll
- Microprocessor
- Detachable Keyboard
- Solid State Keyboard
- Read Terminal Status
- Tilt Screen
- Switchable Emulations

• Circle No. 338

THE FIRST MICROCOMPUTER WHOLESALER



We offer products from many manufacturers including:

Altos
Centronics
Century Data
Control Data
Datasouth
Dyna Byte
Exidy
Hazeltine
Houston Inst.

Impact Data
Industrial Micro
Integral Data
Intertec
Konan
LRC Eaton
Malibu
Micro Peripherals
N.E.C.

North Star
Ohio Scientific
Onyx
PerSci
Qume
Soroc
Televideo
Texas Instruments
Visual Technology

SIGMA (U.K.)
6, THE JAYS,
BURGESS HILL,
SUSSEX

Telephone: 04446-44159

DATASOUTH DS180 HIGH SPEED MATRIX PRINTER

**£1490
+ VAT**



The Datasouth DS180 is a dot-matrix serial impact printer designed for high performance at an economical price. Application flexibility and a long list of standard features make the DS180 an ideal device for small business systems, distributed communications networks and intelligent terminals.

HIGH SPEED PRINTING

Utilizing 180 cps optimized bidirectional printing, the DS180 offers higher throughput than any printer in its class. Its 9-wire printhead produces highly legible 9x7 characters with decenders for lower case letters and true underlining. All 96 ASCII characters may be printed across a 132 column line at 10 characters per inch. Expanded characters (5 cpi) may be selected for highlighting portions of the text.

USER PROGRAMMABLE

The DS180 offers a large number of user programmable features, yet is easy to operate. A unique programming keypad with a non-volatile memory makes printer set-up quick and simple. Top of form, horizontal and vertical tabs, perforation skip-over and auto line feed are just a few of the features the user may select. Communications status may also be programmed and monitored using the indicator panel lights and LED display.

ATTRACTIVE DESIGN

Compact desk-top packaging allows the DS180 to fit into almost any installation. Its noise dampening cover makes it suitable for use in a quiet office environment. The cartridge ribbon makes routine changes clean, fast and convenient.

MICROPROCESSOR ELECTRONICS

Through the use of state-of-the-art microprocessor electronics, reliability and maintainability have been greatly improved. The simple modular design of the DS180 provides easy access to all major components. A single printed circuit board contains both

the power supply electronics and digital controller for the printer. A self-test feature and diagnostic display panel help the user verify proper operation of the unit and isolate problems should they occur.

COMMUNICATIONS

Interfaces on the DS180 include RS232 and 20mA current loop serial interfaces, and a Centronics compatible parallel interface. Baud rates from 110-9600 and parity selection may be keyed in by the user for his specific application.

FORMS HANDLING

Adjustable tractor accommodate forms from 3-15 inches wide. A head-to-platen gap adjustment ensures optimum print quality on up to 6-part forms. Fanfold paper may be fed from the front or bottom of the DS180. A paper out sensor may be programmed to send a slip transmission character and sound an audible alarm.

QUALITY MANUFACTURING

Reliable performance is ensured by a stringent quality control program. Datasouth uses pretested, high reliability parts from leading manufacturers. Multiple tests are performed on sub-assemblies during each stage of production, with each completed unit undergoing a final 24 hour print test and burn-in. The DS180 carries a 90 day warranty on materials and workmanship.

• Circle No. 339

XITAN SYSTEMS

CROMEMCO SYSTEM 3

£4,054.00 for this system with vdu.

The ideal business system. System includes a full 64K fast RAM, dual full-size floppies (Persci 277), RS232 interface/20mamp loop for console device, parallel printer port (Centronics/Anadex compatible), 21 slots for expansion, Lear Siesler 24 lines or 80 chars vdu, and ... CROMEMCO's CDOS operating system with their 14 digit BCD extended disk Basic — ideal for those accurate large numbers required by successful businesses. CDOS is CP/M functionally equivalent, with many extra facilities. Optional extras from Xitan include Fortran, Cobol, Text Formatting, Z-80 macro-relocating assembler and DBMS at £59.00 each, CIS interactive screen handling Cobol at £425.00 (recommended to serious business users), Cromemco S100 boards, CP/M (we are an authorised oem distributor of Digital Research's CP/M) for the System 3, Wordmaster, Wordstar, Supersort, and CPM374X utilities.

ON DEMO NOW! THE CROMEMCO Z2-H

For only £4,995.00 set the reliability and quality of Cromemco, coupled with the capacity of the new IMI 11 megabyte hard disk drive. This is incredible value for money. Specification includes transfer rates of up to 10 times faster than the fastest standard floppy disk, DMA controller for up to 7 hard disk units, and the new extended CDOS operating system. Systems available in three configurations:— A) The Z2-H complete integral system, 64K RAM, Z80A cpu, two double-sided mini-floppies, RS232 console port, parallel printer port, power supplies, cables, case and 12-slot S100 motherboard (7 slots free). B) Additional hard disk subsystem for existing system 2 or system 3 users consisting of one hard disk, DMA controller, power supply, case and cable. C) As unit B but with two hard disks. Prices: Unit A) £5,380.00.
B) £4,330.00.
C) £7,420.00.

COMING SOON! ... Full 7-terminal multi-user operating system from Cromemco for System 3 users. Up to 48K per user, all running independently. This operating system has to be seen to be believed. It will run any of the Cromemco provided and supported software packages, in any combination. Features include partition rescue facilities, allocating more memory to users, real-time clock for time/date stamping of jobs and disk queueing techniques. Buy your System 3 now, expand later as you need it.

Xitan Systems also supplies and stocks vdus, printers, NORTH STAR HORIZON computers, Commodore Business Machines PETs, S100 boards, and books. We are here to demonstrate the range of quality microcomputer systems available for use today. Ring up for an appointment now! You'll not be disappointed. We have Osborne's Sales Ledger and Payable Ledger in source form for use on Cromemco System 3 with CBASIC2, and we can offer a customising service on these programs. Additional software includes Microsoft Basic Interpreter and Compilers, Cbasic, Macro80, and CP/M for the North Star Horizon.

Xitan Systems Ltd., 23 Cumberland Place, Southampton SO1 2BB.

Tel: (0703) 38740

Hours Tue-Sat 9.30 am to 5.30 pm

• Circle No. 340

Advertisement Index

| | | | | | | | |
|--------------------------------|------------|---------------------------|---------|----------------------------|---------|---------------------------|------------|
| A | | Davinci | 40' | Leicester Computer Centre | 186 | S | |
| Adda | 48 | DDP | 118 | Lionhouse Micros | 116 | Science of Cambridge | 104, 105 |
| Acorn Computers | 199 | Digitus | 40 | Little Genius | 116 | Scope | 38 |
| Aculab | 182 | DRG Business Systems | 160 | Liveport | 115 | Sharp Electronics | 165 |
| AJD Direct Supplies | 25 | Dyad Development | 12 | L & J Computers | 111 | Sigma UK | 196 |
| AJ Harding (Molimerx) | 147 | | | Logitek | 52 | Sigmalek | 178 |
| AJR | 190 | E | | London Computer Centre | 146 | Sirton Computers | 177 |
| Almarc | 147 | Electronic Brokers | 4 | Lowe Electronics | 30 | Software House | 36 |
| Anadex | 156 | EMG | 194 | LP Enterprises | 45, 84 | Software Workshop | 162 |
| Andrews Computing | 192 | Equinox | 72 | | | Southdata | 164 |
| Anglia Consultants | 14 | | | M | | Small Systems Engineering | 14, 166 |
| APL | 182 | F | | MAP | 192 | Spot | 172 |
| B | | Feldon Audio | 24 | Microbits | 152 | Stack | 37 |
| Back Numbers | 159 | Fortronic | 79 | Micro Business Centre | 174 | ST Commercial | 22 |
| Beaver Systems | 174 | | | Microbyte | 71 | Sumlock Bondain | 34 |
| BNR & ES | 184 | G | | Microcentre | 2 | Suncomputers | 157 |
| Bonne Nouvelle | 148 | Gate | 188 | Microcomputer Applications | 26 | Swanley Electronics | 176 |
| Bristol Software Factory | 39 | Galatrek Engineering | 173 | Micro Facilities | 178 | Systematics International | 158 |
| Business Computer Services | 28 | Gemsoft | 33 | Micrologic | 150 | | |
| Business & Leisure Micros | 164 | Geveke Electronics | 90 | Microprint | 166 | T | |
| Buss Stop | 36 | GP Industrial Electronics | 194 | Microprint | 150 | Tanberg | 181 |
| Byte Shop Computerland | 108 | Grafcom | 180 | Micropute | 18 | Tandy Computers | 8, 9 |
| Bytronix | 78 | Graham Dorlan | 51 | Microtrend | 162 | TCL Pascal | 102 |
| | | Grama Winter | 10, 11 | Microtrend | 53 | TDS | 194 |
| | | Guestel | 14 | Might Micro | 106 | Telesystems | 38 |
| | | | | Millbank | 19, 101 | Thistle | 111 |
| | | | | Mutek | 32 | Tim Orr Design | 180 |
| C | | H | | N | | Total Concept Systems | 192 |
| Caddis | 172 | Hal Computers | 23 | Newtronics | 33 | Transam | 21 |
| Cambridge Computer Store | 101 | Ham & Gibson | 176 | NSC | 161 | T & V Johnson | 175 |
| Cambridge Learning Enterprises | 169 | HB Computers | 120 | | | Tycho Business Systems | 184 |
| Camden Electronics | 189 | Henry's Radio | 163 | O | | | |
| Cetronic | 45 | Hewlett Packard | 29 | Owl-Computers | 176 | U | |
| Chaljo | 184 | Houghton Insel | 20 | | | UI Management Consultants | 166 |
| Chromasonic | 15 | HSV | 101 | P | | | |
| Clenlo | 191 | Hytech | 22 | Padmede | 102 | V | |
| Comart | 5, 15 | | | Paper Shack | 186 | Vision Business Systems | 154 |
| Commodore | 91, 92, 99 | I | | Peripheral Hardware | 20 | V & T Electronics | 18 |
| Comp Shop | 198, 199 | Icarus | 89 | Personal Computers | 155 | Volker-Craig | 153 |
| Compsort | 170 | Informex Centralex | 188 | Petalact | 150 | | |
| Compec | 179 | Infracomputer systems | 151 | Pete & Pam Computers | 168 | W | |
| Computer Bookshop | 183 | Intelligent Artefacts | 26, 172 | Petsoft | 43 | West Electronics | 38 |
| Computech | 167 | Interface Components | 168 | Practical Computing | 168 | Wego | 4 |
| Computerama | 195 | Intex Datalog | 16 | Printout | 122 | Westrex | 180 |
| Computerbit | 185 | Itthaca Intersystems | 200 | Pyral Magnetics | 176 | Wey Fringe | 55 |
| Computopia | 36 | | | | | Wilkes | 186 |
| Control Dataset | 16 | K | | Q | | | |
| Creamwood | 24 | Kansas City Systems | 174 | Q Com | 160 | X | |
| Crofton Electronics | 16 | Keen Computers | 54 | Q Tek | 111 | Xitan | 197 |
| Crystal Electronics | 31 | KGB | 107 | Qwerty | 178 | | |
| Cumana | 112 | Kobra | 124 | | | Z | |
| | | Kode | 12 | R | | Zenith Heathkit | 31, 33, 35 |
| D | | | | Rair | 103 | Zero One | 31 |
| Dataink | 193 | L | | Research Machines | 187 | | |
| Datron Microcentre | 17 | Landsler Software | 190 | | | | |

COMPUPHONES

YOU NEED NEVER MISS AN IMPORTANT CALL AGAIN TWO CORDLESS TELEPHONE SYSTEMS — DIRECT FROM USA



THE ALCOM only **£147 + VAT**
Base station connects to your telephone line. Remote handset clips to your belt and gives you push-button dialling — Bleeps when call arriving — Nicad rechargeable batteries. Charger in base unit.



THE BOHSEI only **£125 + VAT**
Base station connects to your telephone line. Remote handset stylishly designed in red — Push button dialling comes complete with charger unit for batteries in handset.



LOW COST TELEPHONE ANSWERING MACHINE only **£99.95 + VAT**
Microprocessor controlled answering machine. Plug into your phone line. Records any phone call messages. Remote bleeper enables you to listen to your messages from anywhere in the world. Uses standard cassettes. Comes complete with mains adaptor, microphone, remote bleeper, base unit, cassette with 30 sample pre-recorded messages.

THE NEW ANADEX DP9501

A PROFESSIONAL PRINTER

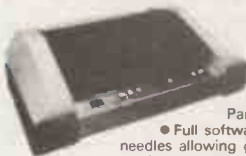

- Bi-directional printing
- Up to 220 chars/line with 4 print densities
- 500 char buffer
- RS232C and Centronics Parallel interface built in
- Full software control of matrix needles allowing graphics capability
- 200 chars/sec ● Adjustable width tractor feed.

All this for only **£995 + VAT**.

NASCOM-2 WITH FREE POWER SUPPLY & 16K RAM B BOARD

only **£305 + VAT** Subject to Availability

NASCOM 2 DISC DRIVES

Add a powerful, double density, mini floppy disc to your Nascom system.

- Disc Controller Card includes Nasbus 6 S100 interface
- Will control 4 Drives.
- CPM operating system.
- Extended Disc Basic Compiler.
- Power supply included

One Disc System — **£499 + VAT**
Additional Disc Unit — **£299 + VAT**



COMPLETE MICRO SYSTEMS



only **£349 + VAT**

TRS80 LEVEL 2 16K
Fully converted to UK T.V. Standard. Comes complete with easy to follow manuals, UK Power Supply — Cassette Leads — Sample tapes. Special box to enable you to plug into your own TV. Recommended for first-time buyers. Just plug in and go. Full Range of Software Available

Interface to Centronics Parallel for TRS80 **£75.00 + VAT**

TRS80 EXPANSION INTERFACE

only **£295 + VAT**
Expand your TRS80 by 32K. 32K Memory on board. Centronics parallel port. Disk controller card. Real time clock. Requires Level II Basic. Interface for 2 cassette decks. complete with power supply.

NEW REDUCED PRICES

8K **£399**
16K **£499**
32K **£599**

RRP £795 for 32K

The PEDIGREE PETS Very popular for home & business use. 8K Microsoft Basic in ROM. 8K Pet 32K & 16K with new improved keyboard. All with green screen. Cassette Deck **£55** extra Full range of software available. Interface PET IEEE — Centronics Parallel Not decoded **£49.00 + VAT** Decoded **£77.00 + VAT**

PRINTERS

SPECIAL SCOOP GET YOURSELF A PRINTER FOR YOUR PET AND SAVE A FORTUNE

only **£349 + VAT**

Full Pet Graphics including cables. Ready to go. **EX-STOCK.**



RRP **£540** only **£479 + VAT**
ANADEX DP8000
Super Quality — Low cost printer. Tractor Feed with full 96 ASCII character set. Accepts RS232C at baud rates between 100 and 9600 and Parallel Bit data. Attaches either directly or through interfaces to Pet, Apple, TRS80, Sorcerer, Nascom, Compukit etc.

MONITORS



video 100

12" BLACK & WHITE LOW COST VIDEO MONITOR

only **£79 + VAT**

- Ideal for home, personal and business computer systems
- 12" diagonal video input
- Composite video input
- Composite video input
- Compatible with many computer systems
- Solid-state circuitry for a stable & sharp picture
- Video bandwidth - 12MHz + 3DB
- Input Impedance - 75 Ohms
- Resolution - 650 lines Minimum In Central 80% of CRT; 550 Lines Minimum beyond central 80%.

16K **£399 + VAT**
32K — **£449 + VAT**
48K — **£499 + VAT**



EXIDY SORCERER



RRP **£740** for 16K

For Personal or Business Use
16K, 32K or 48K memory. 8K Microsoft Basic in ROM. Dual Cassette I/O, RS232 I/O. Parallel I/O (Centronics). Expansion available through optional extra S100 Motherboard. 69 Key keyboard including 16 Key numeric pad. *Extended Warranty by COMPUCARE*

WE ARE NOW STOCKING THE APPLE II EUROPLUS AT REDUCED PRICES



48K **£690**
32K **£649**
16K **£599**

Getting Started APPLE II is faster, smaller, and more powerful than its predecessors. And it's more fun to use too because of built-in features like:

- BASIC — The Language that Makes Programming Fun.
- High-Resolution Graphics (in a 54,000-Point Array) for Finely-Detailed Displays.
- Sound Capability that Brings Programs to Life.
- Hand Controls for Games and Other Human-Input Applications.
- Internal Memory Capacity of 48K Bytes of RAM, 12K Bytes of ROM; for Big-System Performance in a Small Package.
- Eight Accessory Expansion Slots to let the System Grow With Your Needs.

You don't need to be an expert to enjoy APPLE II. It is a complete, ready-to-run computer. Just connect it to a video display and start using programs (or writing your own) the first day. You'll find that its tutorial manuals help you make it your own personal problem solver.

NEC SPINWRITER

only **£1599 + VAT**



NEC's high quality printer uses a print "thimble" that has less diameter and inertia than a daisy wheel, giving a quieter, faster, more reliable printer that can cope with plotting and printing (128 ASCII characters) with up to five copies, friction or tractor fed. The ribbon and thimble can be changed in seconds. 55 characters per second bidirectional printing — with red/black, bold, subscript, bidirectional, proportional spacing, tabbing, and much, much more.

THE ATARI VIDEO COMPUTER GAMES SYSTEM

£99.00 + VAT



Atari's Video Computer System now offers more than 1300 different game variations and options in twenty great Game Program™ cartridges!

Have fun while you sharpen your mental and physical coordination. You can play rousing, challenging, sophisticated video games, the games that made Atari famous. You'll have thrill after thrill, whether you're in the thick of a dogfight, screaming around a racetrack, or dodging asteroids in an alien galaxy. With crisp bright colour (on colour TV) and incredible, true-to-life sound effects. With special circuits to protect your TV.

Most Cartridges only **£13.90 + VAT** Prices may vary with special editions Basic Maths, Airsea Battle, Black Jack, Breakout, Surround, Spacewar, Video Olympics, Outlaw, Basketball, Hunt & Score*, Space War, Sky Diver, Air Sea Battle, Codebreaker*, Miniature Golf.

Extra Paddle Controllers — **£14.90 + VAT**

*Keyboard Controllers — **£16.90 + VAT**

STOP PRESS SPACE INVADERS NOW IN STOCK £25 + VAT

JUST COMPARE OUR CASH AND CARRY PRICES!



EUROPE'S FASTEST SELLING ONE BOARD COMPUTER COMPUKIT UK101

★ 6502 based system — best value for money on the market. ★ Powerful 8K Basic — Fastest around ★ Full Qwerty Keyboard ★ 4K RAM Expandable to 8K on board. ★ Power supply and RF Modulator on board. ★ No Extras needed — Plug-in and go. ★ Kansas City Tape Interface on board. ★ Free Sampler Tape including powerful Disassembler and Monitor with each Kit. ★ If you want to learn about Micros, but didn't know which machine to buy then this is the machine for you.

- 40 pin Expansion Jumper Cable for CompuKit expansion **£8.50 + VAT**
- Build, Understand and Program your own Computer for only a small outlay
- KIT ONLY £179 + VAT NO EXTRAS NEEDED**
- Available ready assembled, tested & ready to go **£229 + VAT**

NEW MONITOR FOR COMPUKIT UK101

- In 2K Eprom 2716 ● Allows screen editing ● Saves data on tape ● Flashing cursor ● Text scrolls down **£22.00 + VAT**

FOR THE COMPUKIT

| | |
|--------------------|---------------|
| Assembler/Editor | £14.90 |
| Screen Editor Tape | £5.90 |

Game Packs

| | |
|------------------------|--------------|
| 1. Four Games | £5.00 |
| 2. Four Games | £5.00 |
| 3. Three Games 8K only | £5.00 |

| | |
|-------------------|---------------|
| Space Invaders | £5.00 |
| Chequers | £3.00 |
| Real Time Clock | £3.00 |
| Case for CompuKit | £29.50 |

All Prices exclusive VAT

THE ATARI VIDEO COMPUTER GAMES SYSTEM

Atari's Video Computer System now offers more than 1300 different game variations and options in twenty Game Program™ cartridges!

Most Cartridges only **£13.90 + VAT**
Prices may vary with special editions Basic Maths, Airsea Battle, Black Jack, Breakout, Surround, Spacewar, Video Olympics, Outlaw, Basketball, Hunt & Score*, Space War, Sky Diver, Air Sea Battle, Codebreaker*, Miniature Golf.

Extra Paddle Controllers *Keyboard Controllers
— **£14.90 + VAT** — **£16.90 + VAT**

SPACE INVADERS NOW IN STOCK £25

SPECIAL—ONCE IN A LIFETIME OFFER!

16K **£399**
32K **£449**
48K **£499**
+ VAT

EXIDY SORCERER

For Personal or Business Use.
32K or 48K memory. 8K Microsoft Basic in ROM: Dual Cassette I/O, RS232 I/O. Parallel I/O (Centronics). Expansion available through optional extra \$100 Motherboard. 69 Key keyboard including 16 key numeric pad.

only **£349 + VAT**

TRS80 LEVEL 2 16K

Fully converted to UK T.V. Standard. Comes complete with easy to follow manuals UK Power Supply — Cassette Leads — Sample tapes Special box to enable you to plug into your own TV. Recommended for first time-buyers Just plug in and go. Full Range of Software Available

Interface to Centronics Parallel for TRS80 **£75.00 + VAT**

only **£295 + VAT**

TRS80 EXPANSION INTERFACE

Expand your TRS80 by 32K. 32K Memory on board. Centronics parallel port Disk controller card. Real time clock. Requires Level II Basic. Interface for 2 cassette decks complete with power supply

only **£79 + VAT**

video 100

12" BLACK & WHITE LOW COST VIDEO MONITOR

- Ideal for home, personal and business computer systems
- 12" diagonal video monitor ● Composite video input
- Composite video input ● Compatible with many computer systems ● Solid-state circuitry for a stable & sharp picture ● Video bandwidth - 12MHz + 3DB ● Input impedance -75 Ohms ● Resolution - 650 lines Minimum In Central 80% of CRT; 550 Lines Minimum beyond central 80%.

NEW TV GAME BREAK OUT

Has got to be one of the world's greatest TV games. You really get hooked. As featured in ETI. Has also 4 other pinball games and lots of options. Good kit for up-grading old amusement games.

MINI KIT — PCB, sound & vision modulator, memory chip and de-code chip. Very simple to construct **£14.90 + VAT**

OR PCB **£2.90** MAIN LSI **£8.50** Both plus VAT



SPECIAL OFFER

We will part exchange your Sinclair ZX80 for any of our products.

Refurbished ZX80's—fully guaranteed **£69.90 + VAT**
(Supply dependant upon stocks).

We have one of the largest collections of Computer Books under one roof, along with racks of software for the PET and TRS80. Come and see for yourself.

WE ARE NOW STOCKING THE APPLE II EUROPLUS AT REDUCED PRICES

16K **£599**
32K **£649**
48K **£690**
+ VAT

Getting Started APPLE II is faster, smaller, and more powerful than its predecessors. And it's more fun to use too because of built-in features like:

- BASIC — The Language that Makes Programming Fun.
- High-Resolution Graphics (in a 54,000-Point Array) for Finely-Detailed Displays.
- Sound Capability that Brings Programs to Life.
- Hand Controls for Games and Other Human-Input Applications.
- Internal Memory Capacity of 48K Bytes of RAM, 12K Bytes of ROM; for Big-System Performance in a Small Package.
- Eight Accessory Expansion Slots to let the System Grow With Your Needs.

You don't need to be an expert to enjoy APPLE II. It is a complete, ready-to-run computer. Just connect it to a video display and start using programs (or writing your own) the first day. You'll find that its tutorial manuals help you make it your own personal problem solver.

EXATRON STRINGY FLOPPY FOR TRS80

(Expansion interface not needed)
only **£169 + VAT**

High Speed storage medium that is cheap and reliable. Includes 20 wafers - M/C monitor - BUS EXPN cable. **£169**

NEW REDUCED PRICES

8K **£399**
16K **£499**
32K **£599**
+ VAT

RRP £795 for 32K

NASCOM-2

WITH FREE POWER SUPPLY & 16K RAM B BOARD
only **£305 + VAT**

Subject to Availability

NASCOM 2 DISC DRIVES

Add a powerful, double density, mini floppy disc to your Nascom system.

- Disc Controller Card (includes Nasbus 6 S100 interface)
- Will control 4 Drives.
- CPM operating system.
- Extended Disc Basic Compiler.
- Power supply included

One Disc System — **£499 + VAT**
Additional Disc Unit — **£299 + VAT**

The PEDIGREE PETS

Very popular for home & business use 8K Microsoft Basic in ROM 8K Pet 32K & 16K with new improved keyboard All with green screen

Cassette Deck **£55** extra Full range of software available.

Interface PET IEEE — Centronics Parallel
Not decoded **£49.00 + VAT** Decoded **£77.00 + VAT**

We give a full one year's warranty on all our products.

We now have in stock demonstration models of the Atari 800 and Texas 99/4. Come and see them

SPECIAL SCOOP GET YOURSELF A PRINTER FOR YOUR PET AND SAVE A FORTUNE

only **£349 + VAT**

Full Pet Graphics including cables. Ready to go.

EX-STOCK.

COMP SHOP

"Europe's Largest Discount Personal Computer Store"

Please add VAT to all prices — including delivery. Please make cheques and postal orders payable to **COMP SHOP LTD.**, or phone your order quoting **BARCLAYCARD, ACCESS, DINERS CLUB** or **AMERICAN EXPRESS** number. **CREDIT FACILITIES ARRANGED** — send S.A.E. for application form.

14 Station Road, New Barnet, Hertfordshire, EN5 1QW Telex: 298755 TELCOM G
Telephone: 01-441 2922 (Sales) 01-449 6596

OPEN · 10 am - 7 pm — Monday to Saturday
Close to New Barnet BR Station — Moorgate Line.

★ **NOW IN IRELAND** at: 80 Marlborough St., Dublin 1. Tel: Dublin 749933
★ **COMP SHOP USA**, 1348 East Edinger, Santa Ana, California, Zip Code 92705.
Telephone: 0101 714 5472526

DINERS CLUB INTERNATIONAL

BARCLAYCARD

VISA

COMP COMPUTER COMPONENTS
(Part of the Compshop Ltd. Group)

At Intersystems, "dump" is an instruction.

Not a way of life.

[Or, when you're ready for IEEE S-100, will your computer be ready for you?]



We're about to be gadflies again.

While everyone's been busy trying to convince you that large buses housed in strong metal boxes will guarantee versatility and ward off obsolescence, we've been busy with something better. Solving the *real* problem with the first line of computer products built from the ground up to conform to the new IEEE S-100 Bus Standard. Offering you extra versatility in 8-bit applications today. And a full 16 bits tomorrow.

We call our new line Series III™. And even if you don't need the full 24-bit address for up to 16 megabytes (!) of memory right now, they're something to think about. Because of all the perform-

ance, flexibility and economy they offer. Whether you're looking at a new mainframe, expanding your present one or upgrading your system with an eye to the future. (Series II boards are compatible with most existing S-100 systems and *all* IEEE S-100 Standard cards as other manufacturers get around to building them.)

Consider some of the features: Reliable operation to 4MHz and beyond. Full compatibility with 8- and 16-bit CPUs, peripherals and other devices. Eight levels of prioritized interrupts. Up to 16 individually-addressable DMA devices, with IEEE Standard overlapped operation. User-selectable functions addressed by DIP-switch or jumpers, eliminating soldering. And that's just for openers.

The best part is that all this heady stuff is available now! In our advanced processor—a full IEEE Bus Master featuring Memory Map™ addressing to a full megabyte. Our fast, flexible 16K Static RAM and 64K Dynamic RAM boards. An incredibly versatile and

economical 2-serial, 4-parallel Multiple I/O board. 8-bit A/D-D/A converter. Our Double-Density High-Speed Disk Controller. And what is undoubtedly the most flexible front panel in the business. Everything you need for a complete IEEE S-100 system. Available separately, or all together in our new DPS-1 Mainframe!

Whatever your needs, why dump your money into obsolete products labelled "IEEE timing compatible" or other words people use to make up for a lack of product. See the future now, at your Intersystems dealer or call/write for our new catalog. We'll tell you all about Series II and the new IEEE S-100 Bus we helped pioneer. Because it doesn't make sense to buy yesterday's products when tomorrow's are already here.

InterSystems™

Ithaca Intersystems (UK) Ltd.,
Coleridge Lane, Coleridge Road,
London N8 8DD.

Telephone: 01-341-2447/Telex: 299568

